

GOLDEN CORRAL

South 5th St. & West Layton Avenue
Milwaukee, WI

Plant Portfolio for BOZA and Plan Commission Submittal

February 2nd 2017



RED DRAGON JAPANESE MAPLE

Acer palmatum var. dissectum 'Red dragon'



Description:

Prized for its laceleaf foliage and form with Low-branching, dwarf tree with delicate weeping effect. Leaves emerge bright cherry red in spring, mature to burgundy red in summer before finally changing to crimson red in fall. Well-suited for use as a small lawn tree or on patios and entryways. Filtered sun. Moderate grower to 6 -8 feet tall and 6 -8 feet wide.

Flowering:

Flower or Bloom description: Inconspicuous
Flower Color: Purple
Flowering Time/Season: Insignificant flowers in spring

Growth Conditions:

Growth Rate: Slow Growing

Growth Habit: Weeping

Heat Zones:

High: 8 (>90 to 120 days)

Low: 2 (1 to 7 days)

Cold Hardiness:

High: 8 (10 to 20 F)

Low: 5 (-20 to -10 F)

Water Requirements: Water regularly, when top 3 in. of soil is dry

Sun Exposure: Full to partial sun Filtered sun

Care Instructions:

Follow a regular watering schedule during the first growing season to establish a deep, extensive root system. Watering can be reduced after establishment. Feed with a general purpose fertilizer before new growth begins in spring

Plan Reference label: AcruBW

BRANDYWINE RED MAPLE
Acer rubrum 'Brandywine'



Description:

Brandywine has emerald green leaves in summer and bright enduring fall color that begins red and gradually turns brilliant purple red that persists longer than many rubrums, extremely showy. Full sun. An excellent Urban tree that is a seedless male with proven performance. Size: Moderate-growing to 25 to 30 feet high, 12 to 15 feet wide.

Flowering:

Flower or Bloom description: Tiny but conspicuous

Flower Color: Red

Flowering Time/Season: Spring

Growth Conditions:

Growth Rate: Moderate Growing

Growth Habit: Round

Heat Zones:

High: 9 (>120 to 150 days)

Low: 1 (< 1 days)

Cold Hardiness:

High: 8 (10 to 20 F)

Low: 4 (-30 to -20 F)

Water Requirements: Water regularly, when top 3 in. of soil is dry

Sun Exposure: Full sun

Care Instructions:

Follow a regular watering schedule during the first growing season to establish a deep, extensive root system. Watering can be reduced after establishment. Feed with a general purpose fertilizer before new growth begins in spring.

Heritage River Birch Multi
Betula nigra 'Cully'



Description:

A beautiful, multi-stemmed shrubby new birch tree. An outstanding winter specimen when uniquely textured, colorful, peeling bark. Exceptional subject for night lighting. Thrives in problematic low wet soils and high water table. Deciduous tree that will grow to 20 feet tall, 10-20 feet wide.

Flowering:

Flower or Bloom description: Inconspicuous

Flower Color: Yellow

Flowering Time/Season: Spring

Growth Conditions:

Growth Rate: Fast

Growth Habit: Pyramidal

Heat Zones:

High: 9 (>120 to 150 days)

Low: 1 (< 1 days)

Cold Hardiness:

High: 7 (0 to 10 F)

Low: 3 (-40 to -30 F)

Water Requirements: Needs wet or constantly moist soil

Sun Exposure: Full sun

Care Instructions:

Follow a regular watering schedule during the first growing season to establish a deep, extensive root system. Watering can be reduced after establishment. Feed with a general purpose fertilizer before new growth begins in spring.

PRINCETON SENTRY MAIDENHAIR TREE
Ginkgo biloba 'Princeton Sentry'



Description:

This superb deciduous conifer shade tree is a male non-fruiting selection that grows naturally narrow, with an upright, narrowly conical habit. Easily grown in average, medium moisture soil in full sun, branches don't droop and resist breakage. Has fragrant flower. Unique fan-shaped foliage turns golden yellow in fall. It tolerates deer, clay soil, air pollution & thrives in a wide range of soils, tolerant of urban stresses. Full sun. Moderate-growing to 40 to 50 feet high and 20 to 30 in width.

Flowering:

Flower or Bloom description: Catkin like, pendulous
Flower Color: Yellow
Flowering Time/Season: Flowers are inconspicuous.

Growth Conditions:

Growth Rate: Moderate Growing
Growth Habit: Spreading
Heat Zones:

High: 9 (>120 to 150 days)
Low: 3 (>7 to 14 days)

Cold Hardiness:

High: 8 (10 to 20 F)
Low: 3 (-40 to -30 F)

Water Requirements: Water regularly, when top 3 in. of soil is dry
Sun Exposure: Full sun

Care Instructions:

Follow a regular watering schedule during the first growing season to establish a deep, extensive root system. Watering can be reduced after establishment. Feed with a general purpose fertilizer before new growth begins in spring

MARILEE CRABAPPLE
Malus x 'Jarmin'



Description:

An upright, narrow form ornamental tree with pink buds open to unusually large, white, double blooms. Unique for its stiffly upright, narrow form and virtually fruitless nature, it is an excellent choice for courtyard settings and streetscapes, and for use near utility lines. Full sun. Densely branched rounded crown to 24' feet tall & 10' wide.

Flowering:

Flower or Bloom description: Cup Shaped

Flower Color: White

Flowering Time/Season: A vase shaped canopy of white flowers in spring

Growth Conditions:

Growth Rate: Moderate growth

Growth Habit: Upright / Vase shaped

Heat Zones:

High: 8 (>90 to 120 days)

Low: 1 (< 1 days)

Cold Hardiness:

High: 8 (10 to 20 F)

Low: 4 (-30 to -20 F)

Water Requirements: Water regularly, when top 3 in. of soil is dry

Sun Exposure: Full sun

Care Instructions:

Follow a regular watering schedule during the first growing season to establish a deep, extensive root system. Watering can be reduced after establishment. Feed with a general purpose fertilizer before new growth begins in spring.

Chanticleer Flowering Pear
Pyrus calleryana 'Chanticleer'



Description:

Exquisite flowering broadleaf deciduous tree that displays a dazzling profusion of white flowers in early spring. Narrow, pyramidal form is coated with dark green summer foliage turning brilliant reddish-purple in fall. Ideal specimen tree for areas with limited space growing to 30 to 35 ft. tall and 15 ft. wide.

Flowering:

Flower or Bloom description: Clusters of blooms
Flower Color: White
Flowering Time/Season: Spring

Growth Conditions:

Growth Rate: Moderate
Growth Habit: Pyramidal
Heat Zones:
 High: 9 (>120 to 150 days)
 Low: 1 (< 1 days)

Cold Hardiness:
 High: 9 (20 to 30 F)
 Low: 5 (-20 to -10 F)

Water Requirements: Needs regular watering - weekly, or more often in extreme heat, can be reduced after establishment

Sun Exposure: Full Sun

Care Instructions:

Follow a regular watering schedule during the first growing season to establish a deep, extensive root system. Watering may be reduced after establishment. Feed with a general purpose fertilizer before new growth begins in spring.

SKYMASTER ENGLISH OAK
Quercus robur 'Skymaster'**Description:**

A stately specimen with heavy broad branches noted for its unique shape. Narrow when young, it matures to a symmetrical, pyramidal shape. A strong central leader, wide crotch angles and excellent lateral branch development are among the characteristics that make it a distinctive street tree. Deciduous. Full sun. Moderate grower to 50'-0" tall and to 25'-0" wide. Dark green in summer; brown to yellowish in fall.

Flowering:

Flower or Bloom description: Inconspicuous

Flower Color: No Value

Flowering Time/Season: Insignificant spring flowers

Growth Conditions:

Growth Rate: Moderate

Growth Habit: Upright and pyramidal

Heat Zones:

High: 8 (>90 to 120 days)

Low: 3 (>7 to 14 days)

Cold Hardiness:

High: 8 (20 to 30 F)

Low: 4 (-30 to -20 F)

Water Requirements: Water regularly, when top 3 in. of soil is dry

Sun Exposure: Full to partial sun

Care Instructions:

Follow a regular watering schedule during the first growing season to establish a deep, extensive root system. Watering can be reduced after establishment. Feed with a general purpose fertilizer before new growth begins in spring

IVORY SILK JAPANESE TREE LILAC
Syringa reticulata 'Ivory Silk'



Description:

An easy-care lilac which makes an excellent individual accent or street tree. Selected for its compact form and sturdiness. Displays large clusters of pure white blooms at an early age. Moderate-growing to 15 to 25 ft. tall, 10 to 15 ft. wide. Full sun. Deciduous.

Flowering:

Flower or Bloom description: May - June

Flower Color: Creamy white

Flowering Time/Season: Early June for a two week period

Growth Conditions:

Growth Rate: Moderate

Growth Habit: Oval

Heat Zones:

High: 7 (>60 to 90 days)

Low: 1 (< 1 days)

Cold Hardiness:

High: 9 (20 to 30 F)

Low: 4 (-30 to -20 F)

Water Requirements: Once established needs only occasional water.

Sun Exposure: Full sun

Care Instructions:

Follow a regular watering schedule during the first growing season to establish a deep, extensive root system. Feed with a general purpose fertilizer before new growth begins in spring. Increase watering before spring bloom. Prune after flowering

Arctic Sun Red Twig Dogwood
Cornus sanguinea 'Cato'



Description:

This special smaller variety has beautiful yellow stems tipped with red providing a spectacular winter show. It was selected for its naturally compact stature with full branching. Stunning planted in containers or used in cut floral arrangements Use for naturalizing. Full to partial sun. Moderate grower to 3 to 4 feet high, and wide.

Flowering:

Flower or Bloom description: Clusters of star-shaped flowers
Flower Color: White
Flowering Time/Season: White flowers in late spring to summer

Growth Conditions:

Growth Rate: Moderate Growing
Growth Habit: Round
Heat Zones:

High: 8 (>90 to 120 days)
Low: 1 (< 1 days)

Cold Hardiness:

High: 9 (20 to 30 F)
Low: 4 (-30 to -20 F)

Water Requirements: Requires regular watering, weekly or more often in extreme heat
Sun Exposure: Full to partial sun

Care Instructions:

Follow a regular watering schedule during the first growing season to establish a deep, extensive root system. Prefers moist, well-drained soil. Prune immediately after flowering. Fertilize in early spring with a controlled release fertilizer.

BLUE SHADOW WITCH ADLER
Fothergilla major 'Blue Shadow'



Description:

Honey scented white flowers at the tips of branches filled with icy bluish-green leaves. Stunning fall colors of red, orange and yellow that lasts for weeks. Unique color that combines well in a mixed border. Deciduous. Partial to full sun. Slow-growing rounded form to 3 to 5 feet tall, spreading 4 to 5 feet wide.

Flowering:

Flower or Bloom description: Honey-scented white flowers in spring.

Flower Color: White

Flowering Time/Season: Spring.

Growth Conditions:

Growth Rate: Slow

Growth Habit: Round

Heat Zones:

High: 9 (>120 to 150 days)

Low: 1 (< 1 days)

Cold Hardiness:

High: 9 (20 to 30 F)

Low: 4 (-30 to -20 F)

Water Requirements: Needs regular watering - weekly, or more often in extreme heat

Sun Exposure: Full sun to partial shade

Care Instructions:

Follow a regular watering schedule during the first growing season to establish a deep, extensive root system. Watering can be reduced after establishment. Feed with a general purpose fertilizer before new growth begins in spring.

Bobo Hardy Hydrangea
Hydrangea paniculata 'Bobo'**Description:**

A new dwarf hydrangea that is sure to turn heads! Reaching to just three feet tall, it will be engulfed by enormous creamy white flowers in summer, providing a nonstop show until frost. Blossoms are held upright on strong stems, and continue to grow and lengthen as they bloom. In fall, flowers may turn a pinkish hue. An undeniable asset to any garden, particularly where space is limited. Plan in part shade to full sun. Moderate growth 3' tall and 3' to 4' wide.

Flowering:

Flower or Bloom description: Globular flower heads have
Flower Color: White flowers whose color changes light pink.
Flowering Time/Season: Reblooms continuously in summer

Growth Conditions:

Growth Rate: Moderate

Growth Habit: Mounded

Heat Zones:

High: 9 (>120 to 150 days)

Low: 3 (>7 to 14 days)

Cold Hardiness:

High: 9 (20 to 30 F)

Low: 3 (-40 to -30 F)

Water Requirements: Water regularly, when top 3 in. of soil is dry

Sun Exposure: Filtered to partial sun

Care Instructions:

Prefers moist, rich, loamy soil but adaptable to many soil types. Follow a regular watering schedule during the first growing season to develop a deep, extensive root system. Apply a controlled-release fertilizer in early spring. Blooms each year on new wood; prune in late winter or early spring

Limelight Hardy Hydrangea
Hydrangea paniculata 'Limelight'**Description:**

An exciting hardy Hydrangea from Holland, 'Limelight' has unique bright chartreuse blooms in mid-summer that hold bright and refreshing color right into autumn when the blooms change color to a rich deep pink. This is an easy to grow plant with reliable flowering and flower color regardless of soil pH. The flower heads are of good size, ranging from 6 to 12 inches and are held upright on the shrub or as a single stem tree form. An excellent cold hardy addition to dappled shade under tree canopies. Deciduous. Shade or part shade. Moderate growth 6' to 8' feet tall and as wide.

Flowering:

Flower or Bloom description: Globular flower heads have

Flower Color: bright chartreuse flowers whose color changes before rich deep pink.

Flowering Time/Season: Reblooms continuously in summer

Growth Conditions:

Growth Rate: Moderate

Growth Habit: Mounded

Heat Zones:

High: 9 (>120 to 150 days)

Low: 3 (>7 to 14 days)

Cold Hardiness:

High: 9 (20 to 30 F)

Low: 3 (-40 to -30 F)

Water Requirements: Water regularly, when top 3 in. of soil is dry

Sun Exposure: Filtered to partial sun

Care Instructions:

Follow a regular watering schedule during the first growing season to establish a deep, extensive root system. Provide well-drained soil, rich in organic matter. Feed with an acid fertilizer before spring growth. Prune to shape after flowering

Plan Reference Tag: PhopTW

Tiny Wine Ninebark
Physocarpus opulifolius 'Tiny Wine'



Description:

A full, dwarf variety with small, refined leaves. The dark bronze-maroon foliage is colorful all season and contrasts beautifully with soft pink and white flowers in late spring. The dainty flowers cover the stems, providing an exceptionally showy display. This durable shrub is perfect for season-long color in the landscape. Useful accent for small urban gardens or massed in a low maintenance landscape. Deciduous. Full sun. Moderate-growing to 3 to 4 feet high, equal width.

Flowering:

Flower or Bloom description: Button-shaped Clusters

Flower Color: Burgandy leaves / Pink flowers

Flowering Time/Season: Summer

Growth Conditions:

Growth Rate: Moderate Growing

Growth Habit: Fountain

Heat Zones

High: 7 (>60 to 90 days)

Low: 1 (< 1 days)

Cold Hardiness

High: 8 (10 to 20 F)

Low: 3 (-40 to -30 F)

Water Requirements: Water regularly, when top 3 in. of soil is dry.

Sun Exposure: Full sun

Care Instructions:

Tolerates most soil types. Follow a regular watering schedule during the first growing season to establish a deep, extensive root system. Watering can be reduced after establishment. Apply a controlled release fertilizer before new growth begins in spring..

FLOWER CARPET AMBER GROUND COVER ROSE
Rosa x 'Noa'



Description:

Easy care ground cover shrub that with soft red buds that emerge a profusion of semi-double peachy amber flowers, fading to seashell pink blooming spring through fall - flowers up to 10 months in warmer climates. Blossoms are fragrant Excellent heat and humidity tolerance Glossy, dark green foliage is resistant to mildew and black spot. Ideal in borders, pots, and hanging baskets. Fast growing, spreading shrub 30" tall & wide. Full sun. Deciduous

Flowering:

Flower Color: Peachy / Amber
Flowering Time/Season: Spring through fall.

Growth Conditions:

Growth Rate: Fast Growing

Growth Habit: Spreading

Heat Zones

High: 9 (>120 to 150 days)

Low: 4 (>14 to 30 days)

Cold Hardiness

High: 10 (30 to 40 F)

Low: 4 (-30 to -20 F)

Water Requirements: Water regularly, when top 3 in. of soil is dry.

Sun Exposure: Full to partial sun

Care Instructions:

Water regularly to establish an extensive root system. Protect from extreme cold over first winter. As a ground cover, space plants 3 ft. apart. Feed with a timed-release rose food. Prune to shape in early spring - no fancy pruning is necessary.

DOUBLE PLAY BIG BANG SPIREA
Spiraea japonica 'Tracy'**Description:**

With its dazzling display of colorful foliage and flowers, this fantastic selection provides beauty in the landscape from spring through fall! Emerging spring foliage glows orange, transitions to deep yellow all summer long, returning to rich golden orange in autumn. Massive pink flowers are the largest we've ever seen on a Spiraea. Easy care shrub for borders, perennial beds, or massed to provide outstanding color. Deciduous shrub. Full sun. Medium to fast growth to 2 feet – 3 feet tall and wide.

Flowering:

Flower or Bloom description: Profuse pink clusters
Flower Color: Pink flowers / Yellow /orange foliage
Flowering Time/Season: Pinkish-purple flowers in spring.

Growth Conditions:

Growth Rate: Moderate

Growth Habit: Spreading

Heat Zones:

High: 9 (>120 to 150 days)

Low: 1 (< 1 days)

Cold Hardiness:

High: 9 (10 to 20 F)

Low: 4 (-30 to -20 F)

Water Requirements: Needs regular watering - weekly, or more often in extreme heat

Sun Exposure: Full sun

Care Instructions:

Follow a regular watering schedule during the first growing season to establish a deep, extensive root system. Feed with a general purpose fertilizer before new growth begins in spring. For a tidy, neat appearance, shear annually to shape.

SPICE ISLAND KOREANSPICE VIBURNUM
Viburnum carlesii 'J N Select A'



Description:

Potent spicy scented flowers with better branching than previous carlesii cultivates. Blooms in mid-spring with softball sized clusters of waxy pink flowers that fade to white. Bright red bunches of quarter-inch berries appear in late summer, maturing to black in fall. These stand out from the downy muted green foliage. Foliage color brightens to striking red and rich burgundy in Autumn. A natural in the traditional shrub border or back of perennial beds. Use as foundation plant near windows so fragrance comes inside. Great against long fence lines. Deciduous shrub. Full sun to part shade in south. Slow growing to 5 feet tall and 6 feet wide.

Flowering:

Flower or Bloom description: Clusters of waxy pink flowers that fade to white
Flower Color: White
Flowering Time/Season: Spring

Growth Conditions:

Growth Rate: Slow Growing
Growth Habit: Bushy
Heat Zones:

High: 8 (>90 to 120 days)
Low: 1 (< 1 days)

Cold Hardiness:

High: 8 (10 to 20 F)
Low: 4 (-30 to -20 F)

Water Requirements: Water regularly, when top 3 in. of soil is dry

Sun Exposure: Full to partial sun

Care Instructions:

Follow a regular watering schedule during the first growing season to establish a deep, extensive root system. Watering can be reduced after establishment. Feed with a general purpose fertilizer before new growth begins in spring.

Sonic Bloom Pink Reblooming Weigela
Weigela florida 'Bokrasopin'



Description:

Create an explosion of color with this fantastic new re-blooming selection. Loads of hot pink flowers in spring are followed by waves of blooms until frost! Mounded growth habit with deep green, deer resistant foliage. Reblooms without deadheading, providing season-long color in foundation plantings and borders. Attracts hummingbirds. Deciduous shrub to be planted in full sun. Moderate grower 4 to 5 feet tall and wide.

Flowering:

Flower or Bloom description: Large vase shaped flowers

Flower Color: Hot-pink

Flowering Time/Season: Spring and late summer to hard frost

Growth Conditions:

Growth Rate: Moderate

Growth Habit: Compact spreading

Heat Zones:

High: 9 (>120 to 150 days)

Low: 1 (< 1 days)

Cold Hardiness:

High: 8 (10 to 20 F)

Low: 4 (-30 to -20 F)

Water Requirements: Needs regular watering - weekly, or more often in extreme heat

Sun Exposure: Full Sun

Care Instructions:

Follow a regular watering schedule during the first growing season to establish an extensive root system. Feed regularly during the growing season with a general purpose fertilizer. Prune annually in late winter to promote vigorous new growth.

GOLD CONE JUNIPER

Juniperus communis 'Gold Cone'



Description:

An upright, narrow, columnar, evergreen shrub which features golden new growth foliage. Awl-shaped new growth foliage emerges bright gold in spring with good color retention throughout the summer and early fall. Golden foliage gradually fades to bluish-green in winter. Evergreen. Full sun to part shade. Slow grower to 60 inches tall, 24 inches wide.

Flowering:

Flower or Bloom description: None
Flower Color: No Value
Flowering Time/Season: No noticeable flowers

Growth Conditions:

Growth Rate: Moderate Growing
Growth Habit: Spreading
Heat Zones:
High: 7 (>60 to 90 days)8 (>90 to 120 days)
Low: 1 (< 1 days)
Cold Hardiness:
High: 6 (-10 to 0 F)
Low: 3 (-40 to -30 F)

Water Requirements: Once established needs only occasional water.

Sun Exposure: Full sun to part shade

Care Instructions:

Follow a regular watering schedule during the first growing season to establish a deep, extensive root system. Watering can be reduced after establishment. Feed with a general purpose fertilizer before new growth begins in spring

ALPINE CARPET JUNIPER
Juniperus communis 'Mondap'



Description:

Besides extreme hardiness, this selection with soft-textured, deep blue-green foliage has a low dense spreading habit. It also withstands a wide variance in temperature and humidity. Excellent as a ground cover or for mass plantings. Evergreen. Full sun to part shade. Slow grower to 8 inches tall, 36 to 48 inches wide.

Flowering:

Flower or Bloom description: None
Flower Color: No Value
Flowering Time/Season: No noticeable flowers

Growth Conditions:

Growth Rate: Moderate Growing
Growth Habit: Spreading
Heat Zones:
 High: 7 (>60 to 90 days)8 (>90 to 120 days)
 Low: 1 (< 1 days)
Cold Hardiness:
 High: 6 (-10 to 0 F)
 Low: 3 (-40 to -30 F)
Water Requirements: Once established needs only occasional water.
Sun Exposure: Full sun to part shade

Care Instructions:

Follow a regular watering schedule during the first growing season to establish a deep, extensive root system. Watering can be reduced after establishment. Feed with a general purpose fertilizer before new growth begins in spring

SEA OF GOLD JUNIPER
Juniperus x pfitzeriana 'MonSan'



Description:

Even more outstanding golden color on lacy foliage than its Gold Coast parent on the same compact form makes this evergreen shrub an excellent choice as a colorful accent. Color is retained and deepens in winter better than other gold tipped varieties. Full sun. Moderate grower to 3 feet tall, 4 feet wide. Cutting grown

Flowering:

Flower or Bloom description: None
Flower Color: No Value
Flowering Time/Season: No noticeable flowers

Growth Conditions:

Growth Rate: Moderate Growing
Heat Zones
High: 9 (>120 to 150 days)
Low: 1 (< 1 days)
Cold Hardiness
High: 9 (20 to 30 F)
Low: 3 (-40 to -30 F)
Water Requirements: Once established needs only occasional water.
Sun Exposure: Full sun

Care Instructions:

Follow a regular watering schedule during the first growing season to establish a deep, extensive root system. Watering can be reduced after establishment. Feed with a general purpose fertilizer before new growth begins in spring.

DENSE SPREADING YEW
Taxus x media 'Densiformis Select'



Description:

Dense, low, spreading shrub is an excellent basic foundation planting for hedge, screen or border. Dark green foliage backs scarlet berries. Versatile and durable, tolerates shearing well. Evergreen. Full sun. Slow grower to 3 to 4 feet tall and 4 to 6 feet wide.

Flowering:

Flower or Bloom description: None

Flower Color: No Value

Flowering Time/Season: Inconspicuous flowers, dark red fruit.

Growth Conditions:

Growth Rate: Moderate Growing

Growth Habit: Spreading

Heat Zones:

High: 7 (>60 to 90 days)

Low: 1 (< 1 days)

Cold Hardiness:

High: 7 (0 to 10 F)

Low: 4 (-30 to -20 F)

Water Requirements: Water regularly, when top 3 in. of soil is dry

Sun Exposure: Full to partial sun

Care Instructions:

Follow a regular watering schedule during the first growing season to establish a deep, extensive root system. Feed with a general purpose fertilizer before new growth begins in spring. For a tidy, neat appearance, shear annually to shape.

Plan Reference Tag: ThocB

MR. BOWLING BALL ARBORVITAE
Thuja occidentalis 'Bobazam'



Description:

Dwarf, rounded shrub with dense foliage. Lacy, rich green leaf color is retained year-round. Useful as a low hedge or in foundation plantings. Especially useful in areas where space is limited in a spacially challenged garden area. Gently shear for perfect spheres or allow it to mature naturally into versatile oval shape. Evergreen. Full sun. Slow growing 24" to 30" tall and wide.

Flowering:

Flower or Bloom description: None

Flower Color: None

Flowering Time/Season: Insignificant flowers.

Growth Conditions:

Growth Rate: Slow growing

Growth Habit: Round dwarf habit

Heat Zones:

High: 7 (>60 to 90 days)

Low: 1 (< 1 days)

Cold Hardiness:

High: 8 (10 to 20 F)

Low: 3 (-40 to -30 F)

Water Requirements: Once established, needs only occasional watering.

Sun Exposure: Full sun

Care Instructions:

Follow a regular watering schedule during the first growing season to establish a deep, extensive root system. Feed with a general purpose fertilizer before new growth begins in spring. For a tidy, neat appearance, gently shear annually to shape.

HOLMSTRUP ARBORVITAE
Thuja occidentalis 'Holmstrup'**Description:**

Neat, formal appearance to densely branched narrow conical evergreen shrub. Effective landscape accent, windbreak or screen. Its rich green foliage covered form can create handsome framework for doorways or garden entries. Full sun. Slower grower to 5 to 7 feet tall, 2 to 3 feet wide, larger with age.

Flowering:

Flower or Bloom description: None
Flower Color: None
Flowering Time/Season: Insignificant flowers.

Growth Conditions:

Growth Rate: Fast growing
Growth Habit: narrow pyramidal evergreen
Heat Zones:
 High: 7 (>60 to 90 days)
 Low: 1 (< 1 days)
Cold Hardiness:
 High: 8 (10 to 20 F)
 Low: 3 (-40 to -30 F)
Water Requirements: Water regularly, when top 3 in. of soil is dry
Sun Exposure: Full to partial sun

Care Instructions:

Follow a regular watering schedule during the first growing season to establish a deep, extensive root system. Feed with a general purpose fertilizer before new growth begins in spring. For a tidy,

Bronze Veil Tufted Hair Grass
Deschampsia caespitosa 'Bronzschleier'



Description:

One of the best ornamental grasses, it is grown for its huge, graceful flower stalks. It looks good even in winter, with flowering spikes on stout stems that often last into the season, and dense tufts of shiny, dark green leaves. Grows well in full sun and shade. Moderate growing herbaceous perennial that grows 2'-6" to 5'-0" tall & 2'-0" wide.

Flowering:

Flower or Bloom description: Feathery plumes

Flower Color: Tones of green, purple, golden yellow, brown, and silver

Flowering Time/Season: Summer through fall

Growth Conditions:

Growth Rate: Moderate Growing

Growth Habit: Clumping

Heat Zones:

High: 9 (>120 to 150 days)

Low: 1 (< 1 days)

Cold Hardiness:

High: 9 (20 to 30 F)

Low: 4 (-30 to -20 F)

Water Requirements: Water regularly, when top 3 in. of soil is dry

Sun Exposure: Full sun to filtered sun

Care Instructions:

Follow a regular watering schedule during the first growing season to establish a deep, extensive root system. For a neat appearance, remove old foliage before new leaves emerge. Divide clumps every 2 to 3 years in early spring.

Northern Lights Tufted Hair Grass
Deschampsia caespitosa 'Northern Lights'



Description:

Highly variegated green and creamy white leaves have a rosy pink blush when emerging in early spring and again as the weather cools. Flower stems rise from the foliage to a height of 3' in early summer bearing wide, airy panicles of tiny variably-colored flowers which form a cloud over the foliage that is particularly attractive when backlit. One of the few ornamental grasses that grows well in shade. Moderate growing herbaceous perennial that grows 1'-0" tall & wide.

Flowering:

Flower or Bloom description: Feathery plumes of
Flower Color: Tones of gold, silver, purple and green
Flowering Time/Season: Summer through Fall

Growth Conditions:

Growth Rate: Moderate Growing
Growth Habit: Clumping
Heat Zones:

High: 9 (>120 to 150 days)

Low: 1 (< 1 days)

Cold Hardiness:

High: 9 (20 to 30 F)

Low: 4 (-30 to -20 F)

Water Requirements: Water regularly, when top 3 in. of soil is dry

Sun Exposure: Full sun to filtered sun

Care Instructions:

Follow a regular watering schedule during the first growing season to establish a deep, extensive root system. For a neat appearance, remove old foliage before new leaves emerge. Divide clumps every 2 to 3 years in early spring.

Purple Silver Grass
Miscanthus sinensis 'Purpurascens'**Description:**

Bold color in three seasons makes this grass a highly variable accent for gardens.. Slightly gray-green blades in summer turn brilliant red-orange/ Purplish tinge intensifies with onset of fall. Attractive coloring lasting through the winter. Mauve-colored feathery plumes rise above the foliage. A focal point for borders and containers. Herbaceous and Compact, upright clumps 3 to 4 ft. tall and wide; flower stalks 5 to 6 ft. tall.

Flowering:

Flower or Bloom description: Wispy, feathery plumes
Flower Color: Mauve
Flowering Time/Season: Summer into Fall

Growth Conditions:

Growth Rate: Moderate
Growth Habit: Upright
Heat Zones:
 High: 9 (>120 to 150 days)
 Low: 1 (< 1 days)
Cold Hardiness:
 High: 9 (20 to 30 F)
 Low: 4 (-30 to -20 F)

Water Requirements: Needs regular watering - weekly, or more often in extreme heat but can be reduced once established

Sun Exposure: Part Sun to Full Sun

Care Instructions:

Follow a regular watering schedule during the first growing season to establish a deep, extensive root system. For a neat appearance, remove old foliage before new leaves emerge. Divide clumps every 2 to 3 years in early spring. Pruning time: early spring

Plan reference tag: PaviDB

DALLAS BLUES SWITCH GRASS
Panicum virgatum 'Dallas Blues'**Description:**

Wide, erect blades are powder blue during the season provide an excellent backdrop for the stunning reddish-purple plumes that rise above the foliage are beautiful as cut flowers. Quite handsome when used in groups. Herbaceous. Full to partial sun. Clumps to 5 ft. tall, 5 ft. wide

Growth Conditions:

Growth Rate: Fast Growing

Growth Habit: Clumping

Heat Zones

High: 9 (>120 to 150 days)

Low: 1 (>1 days)

Cold Hardiness

High: 9 (20 to 30 F)

Low: 4 (-30 to -20 F)

Water Requirements: Once established needs only occasional water.

Sun Exposure: Full sun

Flowering:

Flower or Bloom description: Airy panicles

Flower Color: Reddish-purple

Flowering Time/Season: Panicles in late summer into fall.

Care Instructions:

Follow a regular watering schedule during the first growing season to establish a deep, extensive root system. For a neat appearance, remove old foliage before new leaves emerge. Divide clumps every 2 to 3 years in early spring.

HOT ROD SWITCH GRASS
Panicum virgatum 'Hot Rod'



Description:

A compact, clumping grass with excellent vertical form. Blue-green foliage during the growing season turns a deep burgundy in summer. Airy purple flower panicles produce showy seed heads that persist for winter interest. Drought and salt tolerant plants are deer resistant and provide protection for wintering songbirds. Herbaceous, Compact, upright clumps 3-4 ft. tall and 2 ft wide.

Flowering:

Flower or Bloom description: Wispy, feathery plumes

Flower Color: Mauve

Flowering Time/Season: Summer into Fall

Growth Conditions:

Growth Rate: Moderate

Growth Habit: Upright

Heat Zones:

High: 9 (>120 to 150 days)

Low: 1 (< 1 days)

Cold Hardiness:

High: 9 (20 to 30 F)

Low: 4 (-30 to -20 F)

Water Requirements: Needs regular watering - weekly, or more often in extreme heat but can be reduced once established

Sun Exposure: Part Sun to Full Sun

Care Instructions:

Follow a regular watering schedule during the first growing season to establish a deep, extensive root system. For a neat appearance, remove old foliage before new leaves emerge. Divide clumps every 2 to 3 years in early spring. Pruning time: early spring

Plan reference tag: PaviN

NORTHWIND SWITCH GRASS
Panicum virgatum 'Northwind'**Description:**

A compact, clumping grass with excellent vertical form. Olive to blue-green foliage during the growing season turns golden-yellow in autumn. Airy flower panicles produce showy seed heads that persist for winter interest. Sturdy stems remain upright even under a snow load, providing protection for wintering songbirds. The root system provides erosion control. Herbaceous. Full to partial sun. Clumps to 4'-6' ft. tall, 2'-3' ft. wide

Growth Conditions:

Growth Rate: Fast Growing

Growth Habit: Clumping

Heat Zones

High: 9 (>120 to 150 days)

Low: 1 (>1 days)

Cold Hardiness

High: 9 (20 to 30 F)

Low: 4 (-30 to -20 F)

Water Requirements: Once established needs only occasional water.

Sun Exposure: Full sun

Flowering:

Flower or Bloom description: Airy panicles

Flower Color: Gray-green

Flowering Time/Season: Panicles in late summer into fall.

Care Instructions:

Follow a regular watering schedule during the first growing season to establish a deep, extensive root system. For a neat appearance, remove old foliage before new leaves emerge. Divide clumps every 2 to 3 years in early spring.

BURGUNDY FIREWORKS CONEFLOWER
Echinacea 'Burgundy Fireworks'



Description:

A flashy coneflower that is an easy to grow flower that produces beautiful, vivid beet-red quill-like ray flowers, unlike any other! Flowers are huge and long-lasting on stout burgundy stems above glossy foliage. Compact and vigorous. Stunning perennial color for beds, borders, wild gardens and containers. Herbaceous. Does not require staking. Hardy, fast growth perennial to 18 inches tall, 18 inches wide.

Flowering:

Flower or Bloom description: Large saucer sized flowers
Flower Color: Fragrant deep red
Flowering Time/Season: Early summer through fall.

Growth Conditions:

Growth Rate: Fast
Growth Habit: Erect
Heat Zones:
High: 9 (>120 to 150 days)
Low: 1 (< 1 days)

Cold Hardiness:
High: 8 (10 to 20 F)
Low: 4 (-30 to -20 F)

Water Requirements: Once established, needs only occasional watering
Sun Exposure: Full sun

Care Instructions:

Follow a regular watering schedule during the first growing season to establish a deep, extensive root system. For a neat appearance, remove old foliage before new leaves emerge. Divide clumps every 2 to 3 years in early spring.

Plan Reference Tag: HeCA

CHICAGO APACHE DWARF DAYLILY
Hemerocallis x 'Chicago Apache'



Description:

Bright red flowers have a vivid yellow throat and slightly ruffled edges. Blooms midseason from June through August. Easy care plant has sunfast color and drought resistance. Herbaceous perennial with Moderate growth to about 28 inches tall and 20 inches wide.

Flowering:

Flower or Bloom description: Vase

Flower Color: Bright wine red with yellow throat blooms

Flowering Time/Season: Mid-season repeat bloomer

Growth Conditions:

Growth Rate: Fast

Growth Habit: Clumping

Heat Zones:

High: 11 (>180 to 210 days)

Low: 3 (>8 to 14 days)

Cold Hardiness:

High: 11 (>120 to 150 days)

Low: 4 (>120 to 150 days)

Water Requirements: Water regularly, when top 3 in. of soil is dry

Sun Exposure: Full sun

Care Instructions:

Follow a regular watering schedule during the first growing season to establish a deep, extensive root system. For a neat appearance, remove old foliage before new leaves emerge. Divide clumps every 2 to 3 years in early spring.

RUBY SPIDER DAYLILY
Hemerocallis x 'Ruby Spider'



Description:

Create a spectacular display with this hardy, award-winning perennial! Enormous, 9-inch dark ruby red flowers with intriguing, spatula-shaped petals that open wide and flat, displaying golden-yellow throats. Adaptable to dry conditions and tolerant of pollution, black walnut trees and salt. Herbaceous perennial with Moderate growth to about 30-34 inches tall and 24 inches wide.

Flowering:

Flower or Bloom description: Vase
Flower Color: Ruby red with gold throat blooms
Flowering Time/Season: Mid-season repeat bloomer

Growth Conditions:

Growth Rate: Fast
Growth Habit: Clumping
Heat Zones:
 High: 11 (>180 to 210 days)
 Low: 3 (>8 to 14 days)
Cold Hardiness:
 High: 11 (>120 to 150 days)
 Low: 4 (>120 to 150 days)
Water Requirements: Water regularly, when top 3 in. of soil is dry
Sun Exposure: Full sun

Care Instructions:

Follow a regular watering schedule during the first growing season to establish a deep, extensive root system. For a neat appearance, remove old foliage before new leaves emerge. Divide clumps every 2 to 3 years in early spring.

Plan Reference Tag: HePF

PEACH FLAMBE CORAL BELLS
Heuchera x 'Peach Flambe'**Description:**

Expect multi-season interest with glowing bright peach-colored leaves infused with flaming red from spring to fall, turning to plum-purple as the weather cools. A superb companion with seasonal garden color. Provides bold texture and color contrast in mixed containers or borders in bright or dappled shade. Evergreen in mild winter climates and is a moderate grower 8" tall, 14" wide; with flower spikes to 16" tall.

Flowering:

Flower or Bloom description: Clusters of vase like flowers

Flower Color: White

Flowering Time/Season: White flowers throughout summer.

Growth Conditions:

Growth Rate: Moderate

Growth Habit: Mounding

Heat Zones:

High: 8 (>90 to 120 days)

Low: 1 (< 1 days)

Cold Hardiness:

High: 9 (20 to 30 F)

Low: 4 (-30 to -20 F)

Water Requirements: Water regularly, when top 3 in. of soil is dry

Sun Exposure: Full to partial sun

Care Instructions:

Follow a regular watering schedule during the first growing season to establish a deep, extensive root system. For a neat appearance, remove old foliage before new leaves emerge. Divide clumps every 2 to 3 years in early spring.

TigerEye Gloriosa Daisy
Rudbeckia 'TigerEye'**Description:**

Possibly the most prolific blooming gloriosa daisy to date, this vigorous hybrid produces masses of golden-yellow blooms with black centers throughout the warm months. Reduced susceptibility to powdery mildew allows the plant to bloom longer. It is a great choice for adding bright, cheerful color to wildflower meadows or informal perennial borders when planted in drifts to achieve a pure mass of color. Herbaceous perennial Full sun. Clusters of stems to 16-24 inches tall & wide.

Flowering:

Flower or Bloom description: Large, daisy-like flower heads

Flower Color: Golden Orange

Flowering Time/Season: Summer through fall

Growth Conditions:

Growth Rate: Fast Growing

Growth Habit: Erect

Heat Zones:

High: 9 (>120 to 150 days)

Low: 2 (1 to 7 days)

Cold Hardiness:

High: 9 (20 to 30 F)

Low: 3 (-40 to -30 F)

Water Requirements: Water regularly, when top 3 in. of soil is dry

Sun Exposure: Full to partial sun

Care Instructions:

Follow a regular watering schedule during the first growing season to establish a deep, extensive root system. Remove old flowers to prolong flowering. For a neat appearance, remove old foliage before new leaves emerge. Divide clumps every 2 to 3 years in early spring.

EAST FRIESLAND MEADOW SAGE
Salvia nemorosa 'East Friesland'



Description:

Showy border selection, desired for the intense violet-blue flower spikes from early summer on 18-inch stalks. Dense erect stems rise from a shrub-like base. Full sun, heat and drought tolerant. Deciduous. Clumps to 18 inches tall, to 24 inches wide.

Flowering:

Flower or Bloom description: Violet-blue, two-lipped flowers grow in very dense whorls on tall spikes

Flower Color: Purple

Flowering Time/Season: From early summer to fall.

Growth Conditions:

Growth Rate: Moderate Growing

Growth Habit: Clumping

Heat Zones:

High: 9 (>120 to 150 days)

Low: 4 (>14 to 30 days)

Cold Hardiness:

High: 9 (20 to 30 F)

Low: 4 (-30 to -20 F)

Water Requirements: Water regularly, when top 3 in. of soil is dry.

Sun Exposure: Full sun

Care Instructions:

Follow a regular watering schedule during the first growing season to establish a deep, extensive root system. Remove old flowers to prolong flowering. Cut back to the ground at the end of the season.



Turfstone Green Permeable Paver System
Turfstone's eco-friendly design reduces storm water run-off and allows turf to grow through it, creating a unique parking solution that works in harmony with nature.







Ashton™ Litter Receptacles



[Close](#)

OSQ Series

OSQ™ LED Area/Flood Luminaire – Medium

Product Description

The OSQ™ Area/Flood luminaire blends extreme optical control, advanced thermal management and modern, clean aesthetics. Built to last, the housing is rugged cast aluminum with an integral, weathertight LED driver compartment. Versatile mounting configurations offer simple installation. Its slim, low-profile design minimizes wind load requirements and blends seamlessly into the site providing even, quality illumination. 'A' and 'B' Input power designators are a suitable upgrade for HID applications up to 250 Watt. 'J' and 'K' Input power designators are a suitable upgrade for HID applications up to 400 Watt.

Applications: Parking lots, walkways, campuses, car dealerships, office complexes, and internal roadways

Performance Summary

NanoOptic® Precision Delivery Grid™ optic

Made in the U.S.A. of U.S. and imported parts

Initial Delivered Lumens: Up to 17,191

Efficacy: Up to 136 LPW

CRI: Minimum 70 CRI (4000K & 5700K; 3000K asymmetric optics); 80 CRI (3000K symmetric optics)

CCT: 3000K (+/- 300K), 4000K (+/- 300K), 5700K (+/- 500K)

Limited Warranty*: 10 years on luminaire/10 years on Colorfast DeltaGuard® finish

*See <http://lighting.cree.com/warranty> for warranty terms

Accessories

Field-Installed	
Backlight Shield OSQ-BLSMF – Front facing optics OSQ-BLSMR – Rotated optics	Hand-Held Remote XA-SENSREM - For successful implementation of the programmable multi-level option, a minimum of one hand-held remote is required

Ordering Information

Fully assembled luminaire is composed of two components that must be ordered separately:

Example: **Mount:** OSQ-AASV + **Luminaire:** OSQ-A-NM-2ME-A-40K-UL-SV

Mount (Luminaire must be ordered separately)	
OSQ-	
OSQ-AA Adjustable Arm OSQ-DA Direct Arm	Color Options: SV Silver BK Black BZ Bronze WH White

Luminaire (Mount must be ordered separately)									
OSQ	A	NM							
Product	Version	Mounting	Optic	Input Power Designator	CCT	Voltage	Color Options	Options	
OSQ	A	NM No Mount	Asymmetric 2ME* Type II Medium 4ME* Type IV Medium 3ME* Type III Medium Symmetric 5ME Type V Medium 5SH Type V Short WSN Wide Sign 15D 15° Flood	A 112W J 168W B 86W K 130W	30K 3000K 40K 4000K 57K 5700K	UL Universal 120-277V UH Universal 347-480V	BK Black BZ Bronze SV Silver WH White	DIM 0-10V Dimming - Control by others - Refer to Dimming spec sheet for details - Can't exceed wattage of specified input power designator F Fuse - When code dictates fusing, use time delay fuse ML Multi-Level - Refer to ML spec sheet for details - High: 100%, Low: 30% - Available with UL voltage only - Intended for downlight applications at 0° tilt PML Programmable Multi-Level, 20-40' Mounting Height - Refer to PML spec sheet for details - Available with UL voltage only - Intended for downlight applications at 0° tilt	PML2 Programmable Multi-Level, 10-30' Mounting Height - Refer to PML spec sheet for details - Available with UL voltage only - Intended for downlight applications at 0° tilt Q9 Field Adjustable Output - Refer to Field Adjustable Output spec sheet for details R NEMA® Photocell Receptacle - Intended for downlight applications with maximum 45° tilt - 3-pin receptacle per ANSI C136.10 - Photocell and shorting cap by others RL Rotate Left - LED and optic are rotated to the left RR Rotate Right - LED and optic are rotated to the right

* Available with Backlight Shield when ordered with field-installed accessory (see table above)

DA Mount

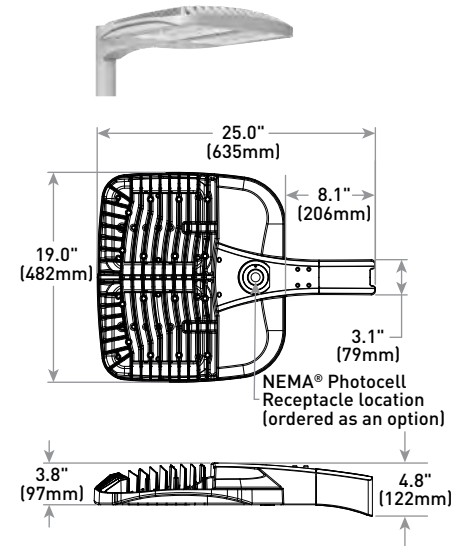

Weight
26.5 lbs. (12kg)



Product Specifications

CONSTRUCTION & MATERIALS

- Slim, low profile design minimizes wind load requirements
- Luminaire housing is rugged die cast aluminum with an integral, weathertight LED driver compartment and high performance heat sink
- Convenient interlocking mounting method on direct arm mount. Mounting adaptor is rugged die cast aluminum and mounts to 3-6" (76-152mm) square or round pole, secured by two 5/16-18 UNC bolts spaced on 2" (51mm) centers
- Mounting for the adjustable arm mount adaptor is rugged die cast aluminum and mounts to 2" (51mm) IP, 2.375" (60mm) O.D. tenon
- Adjustable arm mount can be adjusted 180° in 2.5° increments
- Designed for uplight and downlight applications
- Exclusive Colorfast DeltaGuard® finish features an E-Coat epoxy primer with an ultra-durable powder topcoat, providing excellent resistance to corrosion, ultraviolet degradation and abrasion. Silver, bronze, black, and white are available
- **Weight:** 26.5 lbs. (12kg)

ELECTRICAL SYSTEM

- **Input Voltage:** 120-277V or 347-480V, 50/60Hz, Class 1 drivers
- **Power Factor:** > 0.9 at full load
- **Total Harmonic Distortion:** < 20% at full load
- Integral 10kV surge suppression protection standard
- To address inrush current, slow blow fuse or type C/D breaker should be used
- **10V Source Current:** 0.15mA

REGULATORY & VOLUNTARY QUALIFICATIONS

- cULus Listed
- Suitable for wet locations
- Enclosure rated IP66 per IEC 60529 when ordered without R option
- Consult factory for CE Certified products
- Certified to ANSI C136.31-2001, 3G bridge and overpass vibration standards
- 10kV surge suppression protection tested in accordance with IEEE/ANSI C62.41.2
- Meets FCC Part 15 , Subpart B, Class A standards for conducted and radiated emissions
- Luminaire and finish endurance tested to withstand 5,000 hours of elevated ambient salt fog conditions as defined in ASTM Standard B 117
- Meets Buy American requirements within ARRA
- DLC qualified when ordered with asymmetric optics with 40K or 57K. Please refer to www.designlights.org/QPL for most current information
- RoHS compliant. Consult factory for additional details

Electrical Data*								
Input Power Designator	Optic	System Watts 120-480V	Total Current					
			120V	208V	240V	277V	347V	480V
A	Asymmetric	112	0.97	0.56	0.49	0.43	0.34	0.25
		168	1.47	0.85	0.74	0.64	0.50	0.36
B	Symmetric	86	0.73	0.43	0.37	0.32	0.25	0.19
K		130	1.09	0.65	0.56	0.49	0.38	0.28

* Electrical data at 25°C (77°F). Actual wattage may differ by +/- 10% when operating between 120-480V +/-10%

Recommended OSQ Series Lumen Maintenance Factors (LMF) ¹						
Ambient	Optic	Initial LMF	25K hr Projected ² LMF	50K hr Projected ² LMF	75K hr Projected ² LMF	100K hr Calculated ³ LMF
5°C (41°F)	Asymmetric	1.04	0.99	0.93	0.89	0.84
	Symmetric	1.05	1.00	0.96 ³	0.92 ³	0.88 ³
10°C (50°F)	Asymmetric	1.03	0.98	0.93	0.88	0.83
	Symmetric	1.04	0.99	0.95 ³	0.91 ³	0.87 ³
15°C (59°F)	Asymmetric	1.02	0.97	0.92	0.87	0.82
	Symmetric	1.02	0.98	0.94 ³	0.90 ³	0.87 ³
20°C (68°F)	Asymmetric	1.01	0.96	0.91	0.86	0.82
	Symmetric	1.01	0.96	0.92 ³	0.88 ³	0.85 ³
25°C (77°F)	Asymmetric	1.00	0.95	0.90	0.85	0.81
	Symmetric	1.00	0.95	0.91 ³	0.88 ³	0.84 ³

¹ Lumen maintenance values at 25°C (77°F) are calculated per TM-21 based on LM-80 data and in-situ luminaire testing
² In accordance with IESNA TM-21-11, Projected Values represent interpolated value based on time durations that are within six times (6X) the IESNA LM-80-08 total test duration [in hours] for the device under testing [IDUT] i.e. the packaged LED chip
³ In accordance with IESNA TM-21-11, Calculated Values represent time durations that exceed six times (6X) the IESNA LM-80-08 total test duration [in hours] for the device under testing [IDUT] i.e. the packaged LED chip

AA Mount

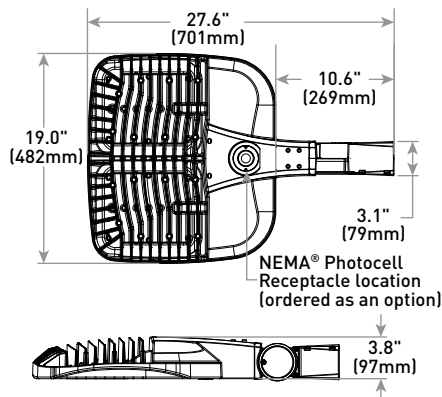

Weight
26.5 lbs. (12kg)



Photometry

All published luminaire photometric testing performed to IESNA LM-79-08 standards by a NVLAP accredited laboratory. To obtain an IES file specific to your project consult: <http://lighting.cree.com/products/outdoor/area/osq-series>

2ME

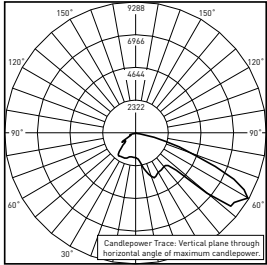

RESTL Test Report #: PL03347-001
OSQ-A**-2ME-A-40K-UL
Initial Delivered Lumens: 10,988

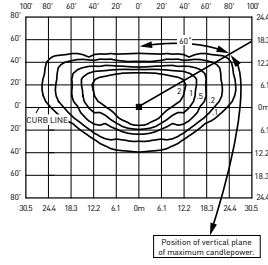

OSQ-A**-2ME-J-40K-UL
Mounting Height: 25' (7.6m) A.F.G.
Initial Delivered Lumens: 16,356
Initial FC at grade

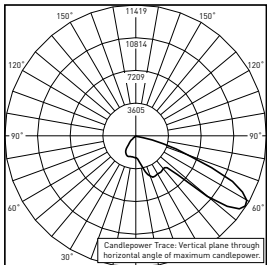

RESTL Test Report #: PL03642-003
OSQ-A**-2ME-J-40K-UL w/OSQ-BLSMF
Initial Delivered Lumens: 14,643

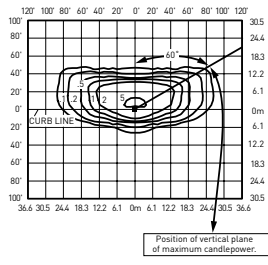

OSQ-A**-2ME-J-40K-UL w/OSQ-BLSMF
Mounting Height: 25' (7.6m) A.F.G.
Initial Delivered Lumens: 14,020
Initial FC at grade

Type II Medium Distribution

Input Power Designator	3000K		4000K		5700K	
	Initial Delivered Lumens*	BUG Ratings** Per TM-15-11	Initial Delivered Lumens*	BUG Ratings** Per TM-15-11	Initial Delivered Lumens*	BUG Ratings** Per TM-15-11
A	9,136	B2 U0 G1	10,904	B2 U0 G2	11,649	B2 U0 G2
J	13,703	B2 U0 G2	16,356	B3 U0 G2	17,474	B3 U0 G2

* Initial delivered lumens at 25°C (77°F). Actual wattage may differ by +/- 10% when operating between 120-480V +/- 10%

** For more information on the IES BUG (Backlight-Uplight-Glare) Rating visit: www.ies.org/PDF/Erratas/TM-15-11BugRatingsAddendum.pdf. Valid with no tilt

Type II Medium w/BLS Distribution

Input Power Designator	3000K		4000K		5700K	
	Initial Delivered Lumens*	BUG Ratings** Per TM 15 11	Initial Delivered Lumens*	BUG Ratings** Per TM 15 11	Initial Delivered Lumens*	BUG Ratings** Per TM 15 11
A	7,831	B1 U0 G1	9,346	B2 U0 G2	9,985	B2 U0 G2
J	11,746	B2 U0 G2	14,020	B2 U0 G2	14,978	B2 U0 G2

* Initial delivered lumens at 25°C (77°F). Actual wattage may differ by +/- 10% when operating between 120-480V +/- 10%

** For more information on the IES BUG (Backlight-Uplight-Glare) Rating visit: www.ies.org/PDF/Erratas/TM-15-11BugRatingsAddendum.pdf. Valid with no tilt

3ME

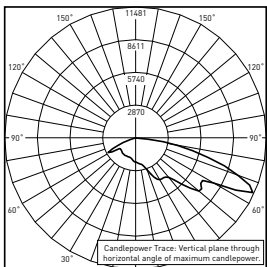

RESTL Test Report #: PL03478-001
OSQ-A**-3ME-J-40K-UL
Initial Delivered Lumens: 16,257

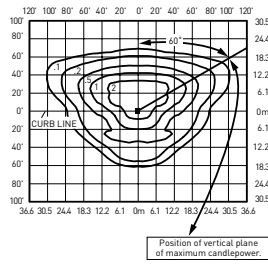

OSQ-A**-3ME-J-40K-UL
Mounting Height: 25' (7.6m) A.F.G.
Initial Delivered Lumens: 16,189
Initial FC at grade

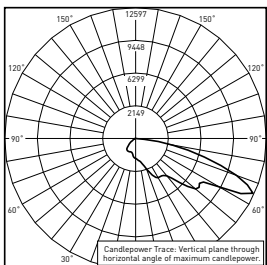

RESTL Test Report #: PL03642-001
OSQ-A**-3ME-J-40K-UL w/OSQ-BLSMF
Initial Delivered Lumens: 14,229

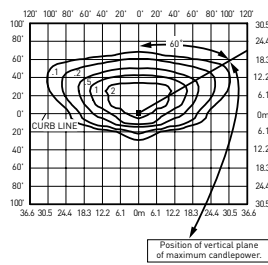

OSQ-A**-3ME-J-40K-UL w/OSQ-BLSMF
Mounting Height: 25' (7.6m) A.F.G.
Initial Delivered Lumens: 13,853
Initial FC at grade

Type III Medium Distribution

Input Power Designator	3000K		4000K		5700K	
	Initial Delivered Lumens*	BUG Ratings** Per TM 15 11	Initial Delivered Lumens*	BUG Ratings** Per TM 15 11	Initial Delivered Lumens*	BUG Ratings** Per TM 15 11
A	9,042	B2 U0 G2	10,793	B2 U0 G2	11,530	B2 U0 G2
J	13,564	B3 U0 G3	16,189	B3 U0 G3	17,296	B3 U0 G3

* Initial delivered lumens at 25°C (77°F). Actual wattage may differ by +/- 10% when operating between 120-480V +/- 10%

** For more information on the IES BUG (Backlight-Uplight-Glare) Rating visit: www.ies.org/PDF/Erratas/TM-15-11BugRatingsAddendum.pdf. Valid with no tilt

Type III Medium w/BLS Distribution

Input Power Designator	3000K		4000K		5700K	
	Initial Delivered Lumens*	BUG Ratings** Per TM-15-11	Initial Delivered Lumens*	BUG Ratings** Per TM-15-11	Initial Delivered Lumens*	BUG Ratings** Per TM-15-11
A	7,737	B1 U0 G2	9,235	B1 U0 G2	9,866	B1 U0 G2
J	11,606	B1 U0 G2	13,853	B2 U0 G3	14,799	B2 U0 G3

* Initial delivered lumens at 25°C (77°F). Actual wattage may differ by +/- 10% when operating between 120-480V +/- 10%

** For more information on the IES BUG (Backlight-Uplight-Glare) Rating visit: www.ies.org/PDF/Erratas/TM-15-11BugRatingsAddendum.pdf. Valid with no tilt



OSQ™ LED Area/Flood Luminaire – Medium

Photometry

All published luminaire photometric testing performed to IESNA LM-79-08 standards by a NVLAP accredited laboratory. To obtain an IES file specific to your project consult: <http://lighting.cree.com/products/outdoor/area/osq-series>

4ME

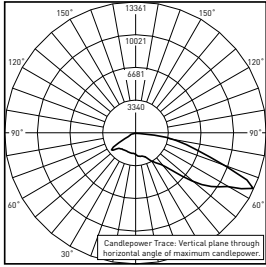

RESTL Test Report #: PL03496-001
OSQ-A**-4ME-J-40K-UL
Initial Delivered Lumens: 16,293

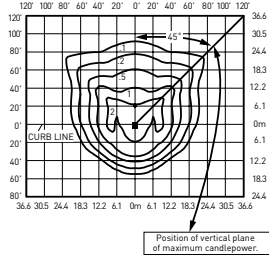

OSQ-A**-4ME-J-40K-UL
Mounting Height: 25' (7.6m) A.F.G.
Initial Delivered Lumens: 16,022
Initial FC at grade

Type IV Medium Distribution						
Input Power Designator	3000K		4000K		5700K	
	Initial Delivered Lumens*	BUG Ratings** Per TM-15-11	Initial Delivered Lumens*	BUG Ratings** Per TM-15-11	Initial Delivered Lumens*	BUG Ratings** Per TM-15-11
A	8,949	B2 U0 G2	10,682	B2 U0 G2	11,412	B2 U0 G3
J	13,424	B3 U0 G3	16,022	B3 U0 G3	17,117	B3 U0 G3

* Initial delivered lumens at 25°C (77°F). Actual wattage may differ by +/- 10% when operating between 120-480V +/- 10%
** For more information on the IES BUG (Backlight-Uplight-Glare) Rating visit: www.ies.org/PDF/Erratas/TM-15-11BugRatingsAddendum.pdf. Valid with no tilt

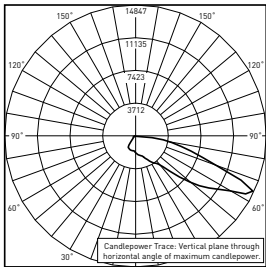

RESTL Test Report #: PL03642-002
OSQ-A**-4ME-J-40K-UL w/OSQ-BLSMF
Initial Delivered Lumens: 13,647

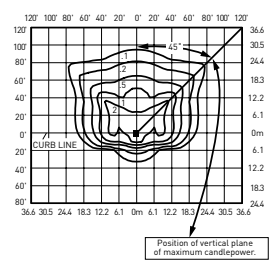

OSQ-A**-4ME-J-40K-UL w/OSQ-BLSMF
Mounting Height: 25' (7.6m) A.F.G.
Initial Delivered Lumens: 13,686
Initial FC at grade

Type IV Medium w/BLS Distribution						
Input Power Designator	3000K		4000K		5700K	
	Initial Delivered Lumens*	BUG Ratings** Per TM 15 11	Initial Delivered Lumens*	BUG Ratings** Per TM 15 11	Initial Delivered Lumens*	BUG Ratings** Per TM 15 11
A	7,644	B1 U0 G2	9,124	B1 U0 G2	9,747	B1 U0 G2
J	11,466	B2 U0 G3	13,686	B2 U0 G3	14,621	B2 U0 G3

* Initial delivered lumens at 25°C (77°F). Actual wattage may differ by +/- 10% when operating between 120-480V +/- 10%
** For more information on the IES BUG (Backlight-Uplight-Glare) Rating visit: www.ies.org/PDF/Erratas/TM-15-11BugRatingsAddendum.pdf. Valid with no tilt

5ME

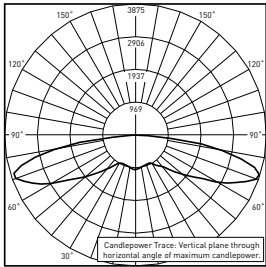

CESTL Test Report #: PL08101-001C
OSQ-A**-5ME-B-30K-UL
Initial Delivered Lumens: 9,304

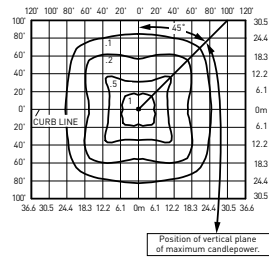

OSQ-A**-5ME-B-40K-UL
Mounting Height: 25' (7.6m) A.F.G.
Initial Delivered Lumens: 10,867
Initial FC at grade

Type V Medium Distribution						
Input Power Designator	3000K		4000K		5700K	
	Initial Delivered Lumens*	BUG Ratings** Per TM-15-11	Initial Delivered Lumens*	BUG Ratings** Per TM-15-11	Initial Delivered Lumens*	BUG Ratings** Per TM-15-11
B	9,387	B3 U0 G3	10,867	B4 U0 G4	11,056	B4 U0 G4
K	13,819	B4 U0 G4	15,999	B4 U0 G5	16,277	B4 U0 G5

* Initial delivered lumens at 25°C (77°F). Actual wattage may differ by +/- 10% when operating between 120-480V +/- 10%
** For more information on the IES BUG (Backlight-Uplight-Glare) Rating visit: www.ies.org/PDF/Erratas/TM-15-11BugRatingsAddendum.pdf. Valid with no tilt

5SH

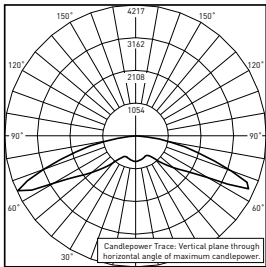

CESTL Test Report #: PL08102-001B
OSQ-A**-5SH-B-30K-UL
Initial Delivered Lumens: 9,935

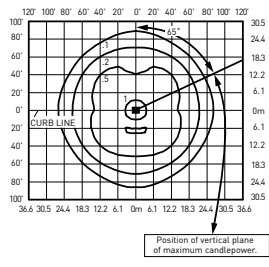

OSQ-A**-5SH-B-40K-UL
Mounting Height: 25' (7.6m) A.F.G.
Initial Delivered Lumens: 11,478
Initial FC at grade

Type V Short Distribution						
Input Power Designator	3000K		4000K		5700K	
	Initial Delivered Lumens*	BUG Ratings** Per TM 15 11	Initial Delivered Lumens*	BUG Ratings** Per TM 15 11	Initial Delivered Lumens*	BUG Ratings** Per TM 15 11
B	9,914	B4 U0 G3	11,478	B4 U0 G3	11,678	B4 U0 G3
K	14,595	B4 U0 G3	16,897	B4 U0 G3	17,191	B4 U0 G3

* Initial delivered lumens at 25°C (77°F). Actual wattage may differ by +/- 10% when operating between 120-480V +/- 10%
** For more information on the IES BUG (Backlight-Uplight-Glare) Rating visit: www.ies.org/PDF/Erratas/TM-15-11BugRatingsAddendum.pdf. Valid with no tilt



Photometry

All published luminaire photometric testing performed to IESNA LM-79-08 standards by a NVLAP accredited laboratory. To obtain an IES file specific to your project consult: <http://lighting.cree.com/products/outdoor/area/osq-series>

15D

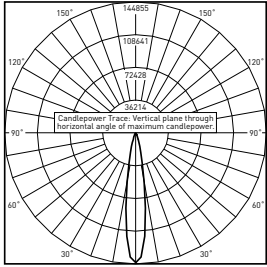

CESTL Test Report #: PL07689-001A
OSQ-A**-15D-U-30K-UL
Initial Delivered Lumens: 23,254

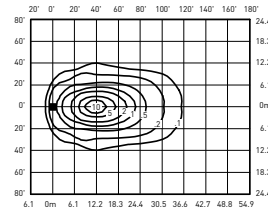

OSQ-A**-15D-B-40K-UL
Mounting Height: 25' (7.6m) A.F.G., 60° Tilt
Initial Delivered Lumens: 11,478
Initial FC at grade

15° Flood Distribution			
Input Power Designator	3000K	4000K	5700K
		Initial Delivered Lumens*	Initial Delivered Lumens*
B	9,914	11,478	11,678
K	14,595	16,897	17,191

* Initial delivered lumens at 25°C (77°F). Actual wattage may differ by +/- 10% when operating between 120-480V +/- 10%

25D

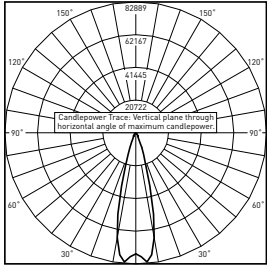

CESTL Test Report #: PL07687-001A
OSQ-A**-25D-U-30K-UL
Initial Delivered Lumens: 23,265

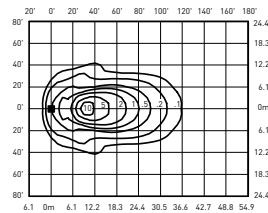

OSQ-A**-25D-B-40K-UL
Mounting Height: 25' (7.6m) A.F.G., 60° Tilt
Initial Delivered Lumens: 11,478
Initial FC at grade

25° Flood Distribution			
Input Power Designator	3000K	4000K	5700K
		Initial Delivered Lumens*	Initial Delivered Lumens*
B	9,914	11,478	11,678
K	14,595	16,897	17,191

* Initial delivered lumens at 25°C (77°F). Actual wattage may differ by +/- 10% when operating between 120-480V +/- 10%

40D

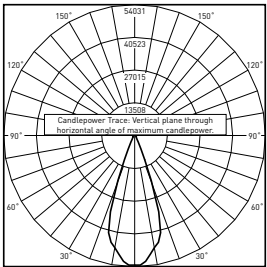

CESTL Test Report #: PL07697-001A
OSQ-A**-40D-U-30K-UL
Initial Delivered Lumens: 22,943

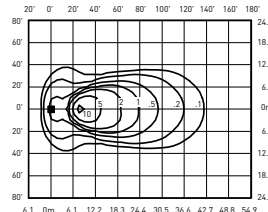

OSQ-A**-40D-B-40K-UL
Mounting Height: 25' (7.6m) A.F.G., 60° Tilt
Initial Delivered Lumens: 11,478
Initial FC at grade

40° Flood Distribution			
Input Power Designator	3000K	4000K	5700K
		Initial Delivered Lumens*	Initial Delivered Lumens*
B	9,914	11,478	11,678
K	14,595	16,897	17,191

* Initial delivered lumens at 25°C (77°F). Actual wattage may differ by +/- 10% when operating between 120-480V +/- 10%

OSQ™ LED Area/Flood Luminaire – Medium

Photometry

All published luminaire photometric testing performed to IESNA LM-79-08 standards by a NVLAP accredited laboratory. To obtain an IES file specific to your project consult: <http://lighting.cree.com/products/outdoor/area/osq-series>

60D

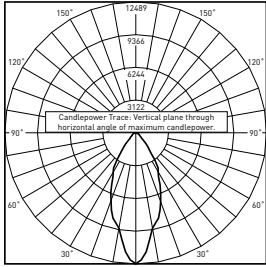

CESTL Test Report #: PL08100-001B
OSQ-A-**-60D-B-30K-UL
Initial Delivered Lumens: 10,079

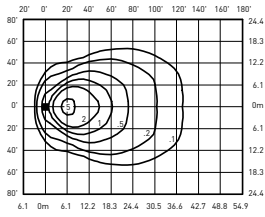

OSQ-A-**-60D-B-40K-UL
Mounting Height: 25' (7.6m) A.F.G., 60° Tilt
Initial Delivered Lumens: 11,478
Initial FC at grade

60° Flood Distribution			
Input Power Designator	3000K	4000K	5700K
		Initial Delivered Lumens*	Initial Delivered Lumens*
B	9,914	11,478	11,678
K	14,595	16,897	17,191

* Initial delivered lumens at 25°C (77°F). Actual wattage may differ by +/- 10% when operating between 120-480V +/-10%

WSN

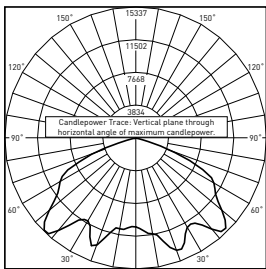

CESTL Test Report #: PL07695-001A
OSQ-A-**-WSN-U-30K-UL
Initial Delivered Lumens: 23,116

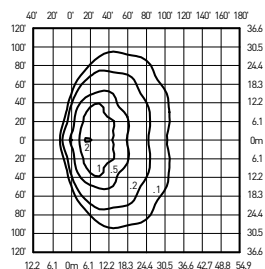















OSQ-A-**-WSN-B-40K-UL
Mounting Height: 25' (7.6m) A.F.G., 60° Tilt
Initial Delivered Lumens: 11,478
Initial FC at grade

Wide Sign Distribution			
Input Power Designator	3000K	4000K	5700K
		Initial Delivered Lumens*	Initial Delivered Lumens*
B	9,914	11,478	11,678
K	14,595	16,897	17,191

* Initial delivered lumens at 25°C (77°F). Actual wattage may differ by +/- 10% when operating between 120-480V +/-10%

Luminaire EPA

Fixed Arm Mount – OSQ-DA Weight: 26.5 lbs. (12kg)					
Single	2 @ 180°	2 @ 90°	3 @ 90°	3 @ 120°	4 @ 90°
					
0.74	1.48	1.19	1.93	1.63	2.38

Adjustable Arm Mount – OSQ-AA Weight: 26.5 lbs. (12kg)							
Single	2 @ 180°	2 @ 90°	3 @ 90°	3 @ 120°	3 @ 180°	4 @ 180°	4 @ 90°
Tenon Configuration [0° -80° Tilt]; If used with Cree tenons, please add tenon EPA with Luminaire EPA							
							
PB-1A*; PT-1; PW-1A3**	PB-2A*; PB-2R2.375; PD-2A4(180); PT-2(180); PW-2A3**	PB-2A*; PD-2A4(90); PT-2(90)	PB-3A*; PD-3A4(90); PT-3(90)	PB-3A*; PT-3(120)	PB-3A*; PB-3R2.375	PB-4A*(180)	PB-4A*(90); PB-4R2.375; PD-4A4(90); PT-4(90)
0° Tilt							
0.74	1.48	1.19	1.93	1.63	3.33	4.66	2.38
10° Tilt							
0.75	1.48	1.49	2.23	2.15	4.22	5.84	2.98
20° Tilt							
1.12	1.48	1.86	2.60	2.85	5.31	7.32	3.72
30° Tilt							
1.46	1.48	2.20	2.94	3.56	6.34	8.68	4.40
45° Tilt							
1.96	1.96	2.69	3.43	4.54	7.83	10.68	5.38
60° Tilt							
2.33	2.33	3.07	3.81	5.11	8.94	12.16	6.14
70° Tilt							
2.49	2.49	3.23	3.97	5.11	9.43	12.80	6.46
80° Tilt							
2.58	2.58	3.32	4.06	5.11	9.71	13.16	6.64
Tenon Configuration [90° Tilt]; If used with Cree tenons, please add tenon EPA with Luminaire EPA							
PB-1A*; PT-1; PW-1A3**	PB-2A*; PB-2R2.375; PD-2A4(180); PT-2(180); PW-2A3**	PB-2A*	PB-3A*	PB-3A*; PT-3(120)	PB-3A*; PB-3R2.375	PB-4A*(180)	PB-4A*(90); PB-4R2.375
90° Tilt							
2.61	2.61	4.44	6.05	5.11	9.79	13.28	10.39

* Specify pole size: 3 [3"], 4 [4"], 5 [5"], or 6 [6"] for single, double or triple luminaire orientation or 4 [4"], 5 [5"], or 6 [6"] for quad luminaire orientation
 ** These EPA values must be multiplied by the following ratio: Fixture Mounting Height/Total Pole Height. Specify pole size: 3 [3"], 4 [4"], 5 [5"], or 6 [6"]



Tenon EPA

Part Number	EPA
PB-1A*	None
PB-2A*	0.82
PB-3A*	1.52
PB-4A*(180)	2.22
PB-4A*(90)	1.11
PB-2R2.375	0.92
PB-3R2.375	1.62
PB-4R2.375	2.32
PD Series Tenons	0.09
PT Series Tenons	0.10
PW-1A3**	0.47
PW-2A3**	0.94
WM-2	0.08
WM-4	0.25
WM-DM	None

* Specify pole size: 3 [3"], 4 [4"], 5 [5"], or 6 [6"] for single, double or triple luminaire orientation or 4 [4"], 5 [5"], or 6 [6"] for quad luminaire orientation
 ** These EPA values must be multiplied by the following ratio: Fixture Mounting Height/Total Pole Height. Specify pole size: 3 [3"], 4 [4"], 5 [5"], or 6 [6"]

Tenons and Brackets* (must specify color)	
Square Internal Mount Vertical Tenons (Steel) - Mounts to 3-6" [76-152mm] square aluminum or steel poles PB-1A* – Single PB-4A*(90) – 90° Quad PB-2A* – 180° Twin PB-4A*(180) – 180° Quad PB-3A* – 180° Triple	Round External Mount Vertical Tenons (Steel) - Mounts to 2.375" [60mm] O.D. round aluminum or steel poles or tenons PB-2R2.375 – Twin PB-4R2.375 – Quad PB-3R2.375 – Triple
Square Internal Mount Horizontal Tenons (Aluminum) - Mounts to 4" [102mm] square aluminum or steel poles PD-2A4(90) – 90° Twin PD-3A4(90) – 90° Triple PD-2A4(180) – 180° Twin PD-4A4(90) – 90° Quad	Round External Mount Horizontal Tenons (Aluminum) - Mounts to 2.375" [60mm] O.D. round aluminum or steel poles or tenons - Mounts to square pole with PB-1A* tenon PT-1 – Single [Vertical] PT-3(90) – 90° Triple PT-2(90) – 90° Twin PT-4(90) – 90° Quad PT-2(180) – 180° Twin
Wall Mount Brackets - Mounts to wall or roof WM-2 – Horizontal for OSQ-AA mount WM-4 – L-Shape for OSQ-AA mount WM-DM – Plate for OSQ-DA mount	Mid-Pole Bracket - Mounts to square pole PW-1A3** – Single PW-2A3** – Double
	Ground Mount Post - For ground mounted flood luminaires PGM-1 - for OSQ-AA mount

* Refer to the [Bracket and Tenons spec sheet](#) for more details

Direct Mount Configurations

Compatibility with OSQ-DA Direct Mount Bracket					
Input Power Designator	2 @ 90°	2 @ 180°	3 @ 90°	3 @ 120°	4 @ 90°
3" Square					
A, J, B & K	N/A	✓	N/A	N/A	N/A
3" Round					
A, J, B & K	N/A	✓	N/A	N/A	N/A
4" Square					
A, J, B & K	✓	✓	✓	N/A	✓
4" Round					
A, J, B & K	✓	✓	✓	✓	✓
5" Square					
A, J, B & K	✓	✓	✓	N/A	✓
5" Round					
A, J, B & K	✓	✓	✓	✓	✓
6" Square					
A, J, B & K	✓	✓	✓	N/A	✓
6" Round					
A, J, B & K	✓	✓	✓	✓	✓

Cree Edge™ Series

LED Pathway Luminaire

Product Description

Durable die-cast aluminum luminaire housing mounts directly to 4" (102mm) diameter pole (included) without visible mounting hardware for clean appearance. Pole mounts to rugged die cast aluminum internal flange secured by three 3/8" - 16x6" anchor bolts with 1-1/4" hook (provided). **Note:** T45 Torx 3/8" socket required for head installation. Top mounted LEDs for superior optical performance and light control.

Applications: Landscape, walk-ways and general site lighting

Performance Summary

Patented NanoOptic® Product Technology

Made in the U.S.A. of U.S. and imported parts

CRI: Minimum 70 CRI

CT: 4000K (+/- 300K), 5700K (+/- 500K) standard

Limited Warranty*: 10 years on luminaire/10 years on Colorfast DeltaGuard® finish

* See <http://lighting.cree.com/warranty> for warranty terms

Accessories

Field-Installed
Upgrade Kit - Used for replacement of existing bollards with a bolt hole circle of 5.75" (146mm) XA-XBP8RSV XA-XBP8RWH XA-XBP8RBK XA-XBP8RBZ

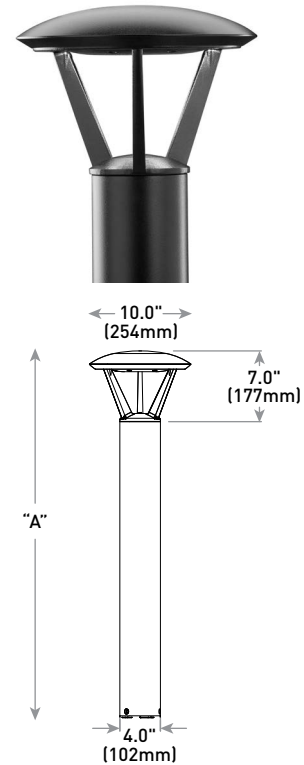

Model	Dim. "A"	Weight*
Landscape (P0)	13" (330mm)	12.7 lbs. (5.8kg)
Landscape (P1)	18" (457mm)	13.3 lbs. (6.0kg)
Pathway (P3)	36" (914mm)	17.9 lbs. (8.1kg)
Pathway (P4)	42" (1068mm)	18.6 lbs. (8.4kg)
Pedestrian (P8)	96" (2438mm)	28.4 lbs (12.9kg)

* Add 4.5 lbs. (2.0kg) for 347-480V

Ordering Information

Example: PWY-EDG-2M-P0-02-E-UL-SV-350

PWY-EDG			02	E				
Product	Optic	Mounting	LED Count (x9)	Series	Voltage	Color Options	Drive Current	Options
PWY-EDG	2M Type II Medium 3M Type III Medium 5M Type V Medium 5S Type V Short	P0 13" (330mm) landscape P1 18" (457mm) landscape P3 36" (914mm) pathway P4 42" (1067mm) pathway P8 96" (2438mm) pedestrian	02	E	UL Universal 120-277V UH* Universal 347-480V - Available with P3, P4, and P8 mounts only 12 120V 27 277V	BK Black BZ Bronze SV Silver WH White	350 350mA 525 525mA - Available with P1, P3, P4, and P8 mounts only	F Fuse - When code dictates fusing, use time delay fuse - Refer to ML spec sheet for availability with ML options HL Hi/Low (Dual Circuit Input) - Available with UL voltage and 525mA driver current only - Refer to HL spec sheet for details - Sensor not included TL Two-Level (175/525 w/integrated sensor control) - Available with 12 or 27 voltages only - Refer to TL spec sheet for details TL2 Two-Level (0/350 w/integrated sensor control) - Available with 12 or 27 voltages only - Refer to TL spec sheet for details TL3 Two-Level (0/525 w/integrated sensor control) - Available with 12 or 27 voltages only - Refer to TL spec sheet for details WB Welded Base Plate - Standard on P8 mount option, available with P3 and P4 mount - Includes welded base cover 40K 4000K Color Temperature - Minimum 70 CRI - Color temperature per luminaire

* 347-480V utilizes magnetic step-down transformer. For input power for 347-480V, refer to the Electrical Data table



Rev. Date: V5 08/11/2016



US: lighting.cree.com/lighting T (800) 236-6800 F (262) 504-5415

Canada: www.cree.com/canada

T (800) 473-1234 F (800) 890-7507

Product Specifications

CONSTRUCTION & MATERIALS

- Durable die-cast aluminum luminaire housing mounts directly to 4" (102mm) diameter pole (included) without visible mounting hardware for clean appearance
- Pole mounts to rugged die cast aluminum internal flange secured by three 3/8"-16x6" anchor bolts with 1-1/4" hook (provided).
Note: T45 Torx 3/8" socket required for head installation
- Top mounted LEDs for superior optical performance and light control
- Exclusive Colorfast DeltaGuard® finish features an E-Coat epoxy primer with an ultradurable powder topcoat, providing excellent resistance to corrosion, ultraviolet degradation and abrasion. Black, bronze, silver and white are available
- **Weight:** See Dimension and Weight Chart on pages 1 and 4

ELECTRICAL SYSTEM

- **Input Voltage:** 120-277V or 347-480V, 50/60Hz, Class 1 drivers
- **Power Factor:** > 0.9 at full load at 120V
- **Total Harmonic Distortion:** < 20% at full load at 120V
- Integral 10kV surge suppression protection standard
- When code dictates fusing, a slow blow fuse or type C/D breaker should be used to address inrush current

REGULATORY & VOLUNTARY QUALIFICATIONS

- cULus Listed
- Suitable for wet locations
- 10kV surge suppression protection tested in accordance with IEEE/ANSI C62.41.2
- Luminaire and finish endurance tested to withstand 5,000 hours of elevated ambient salt fog conditions as defined in ASTM Standard B 117
- Meets Buy American requirements within ARRA
- RoHS compliant. Consult factory for additional details

Electrical Data* (A)								
LED Count (x9)	System Watts 120-277V	System Watts 347-480V	Total Current					
			120V	208V	240V	277V	347V	480V
350mA								
02	22	28	0.18	0.12	0.10	0.10	0.09	0.13
525mA								
02	34	40	0.29	0.19	0.17	0.15	0.12	0.13

* Electrical data at 25°C (77°F). Actual wattage may differ by +/- 10% when operating between 120-480V +/- 10%

Recommended Cree Edge™ Series Lumen Maintenance Factors (LMF) ¹					
Ambient	Initial LMF	25K hr Projected ² LMF	50K hr Projected ² LMF	75K hr Calculated ³ LMF	100K hr Calculated ³ LMF
5°C (41°F)	1.04	0.99	0.97	0.95	0.93
10°C (50°F)	1.03	0.98	0.96	0.94	0.92
15°C (59°F)	1.02	0.97	0.95	0.93	0.91
20°C (68°F)	1.01	0.96	0.94	0.92	0.90
25°C (77°F)	1.00	0.95	0.93	0.91	0.89

¹ Lumen maintenance values at 25°C are calculated per TM-21 based on LM-80 data and in-situ luminaire testing

² In accordance with IESNA TM-21-11, Projected Values represent interpolated value based on time durations that are within six times (6X) the IESNA LM-80-08 total test duration (in hours) for the device under testing (DUT) i.e. the packaged LED chip

³ In accordance with IESNA TM-21-11, Calculated Values represent time durations that exceed six times (6X) the IESNA LM-80-08 total test duration (in hours) for the device under testing (DUT) i.e. the packaged LED chip

Photometry

All published luminaire photometric testing performed to IESNA LM-79-08 standards by a NVLAP accredited laboratory. To obtain an IES file specific to your project consult: <http://lighting.cree.com/products/outdoor/bollards-and-pathway/cree-edge-pathway>

2M

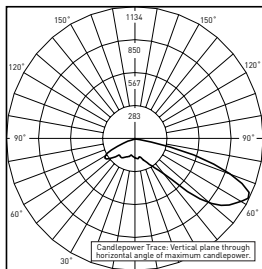

RESTL Test Report #: PL5758-001
 PWY-EDG-2M-**-02-E-UL-350-40K
 Initial Delivered Lumens: 1,549

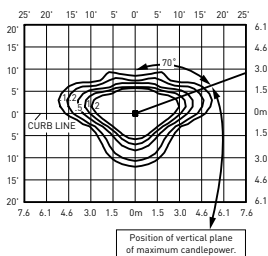

PWY-EDG-2M-**-02-E-UL-350-40K
 Mounting Height: 3' [0.9m] A.F.G.
 Initial Delivered Lumens: 1,565
 Initial FC at grade

Type II Medium Distribution				
LED Count (x9)	4000K		5700K	
	Initial Delivered Lumens*	BUG Ratings** Per TM-15-11	Initial Delivered Lumens*	BUG Ratings** Per TM-15-11
350mA				
02	1,565	B1 U0 G1	1,625	B1 U0 G1
525mA				
02	2,191	B1 U0 G1	2,276	B1 U0 G1

* Initial delivered lumens at 25°C (77°F). Actual production yield may vary between -10 and +10% of initial delivered lumens
 ** For more information on the IES BUG (Backlight-Uplight-Glare) Rating visit: www.ies.org/PDF/Erratas/TM-15-11BugRatingsAddendum.pdf

3M

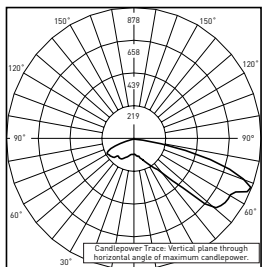

RESTL Test Report #: PL5698-001
 PWY-EDG-3M-**-02-E-UL-350-40K
 Initial Delivered Lumens: 1,470

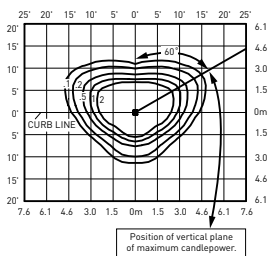

PWY-EDG-3M-**-02-E-UL-350-40K
 Mounting Height: 3' [0.9m] A.F.G.
 Initial Delivered Lumens: 1,389
 Initial FC at grade

Type III Medium Distribution				
LED Count (x9)	4000K		5700K	
	Initial Delivered Lumens*	BUG Ratings** Per TM-15-11	Initial Delivered Lumens*	BUG Ratings** Per TM-15-11
350mA				
02	1,389	B1 U0 G1	1,442	B1 U0 G1
525mA				
02	1,944	B1 U0 G1	2,019	B1 U0 G1

* Initial delivered lumens at 25°C (77°F). Actual production yield may vary between -10 and +10% of initial delivered lumens
 ** For more information on the IES BUG (Backlight-Uplight-Glare) Rating visit: www.ies.org/PDF/Erratas/TM-15-11BugRatingsAddendum.pdf

5M

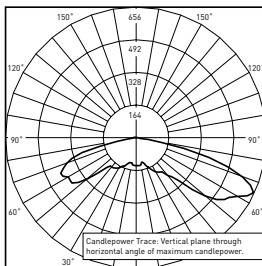

RESTL Test Report #: PL5798-001
 PWY-EDG-5M-**-02-E-UL-350-40K
 Initial Delivered Lumens: 1,780

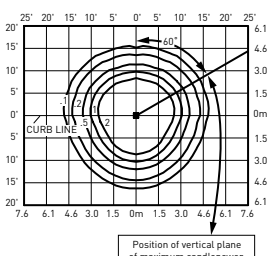

PWY-EDG-5M-**-02-E-UL-350-40K
 Mounting Height: 3' [0.9m] A.F.G.
 Initial Delivered Lumens: 1,666
 Initial FC at grade

Type V Medium Distribution				
LED Count (x9)	4000K		5700K	
	Initial Delivered Lumens*	BUG Ratings** Per TM-15-11	Initial Delivered Lumens*	BUG Ratings** Per TM-15-11
350mA				
02	1,666	B1 U2 G1	1,730	B1 U2 G1
525mA				
02	2,333	B2 U2 G2	2,422	B2 U2 G2

* Initial delivered lumens at 25°C (77°F). Actual production yield may vary between -10 and +10% of initial delivered lumens
 ** For more information on the IES BUG (Backlight-Uplight-Glare) Rating visit: www.ies.org/PDF/Erratas/TM-15-11BugRatingsAddendum.pdf



Photometry

All published luminaire photometric testing performed to IESNA LM-79-08 standards by a NVLAP accredited laboratory. To obtain an IES file specific to your project consult: <http://lighting.cree.com/products/outdoor/bollards-and-pathway/cree-edge-pathway>

55

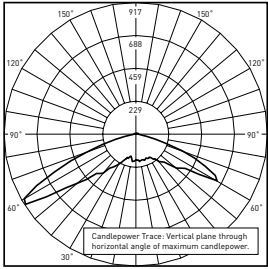

RESTL Test Report #: PL5759-001
 PWY-EDG-5S-**-02-E-UL-350-40K
 Initial Delivered Lumens: 1,897

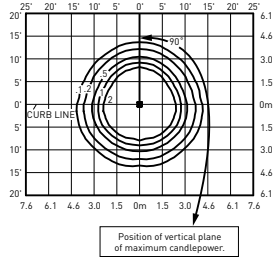

PWY-EDG-5S-**-02-E-UL-350-40K
 Mounting Height: 3' [0.9m] A.F.G.
 Initial Delivered Lumens: 1,868
 Initial FC at grade

Type V Short Distribution				
LED Count (x9)	4000K		5700K	
	Initial Delivered Lumens*	BUG Ratings** Per TM-15-11	Initial Delivered Lumens*	BUG Ratings** Per TM-15-11
350mA				
02	1,868	B1 U2 G1	1,940	B1 U2 G1
525mA				
02	2,615	B1 U2 G1	2,716	B1 U2 G1

* Initial delivered lumens at 25°C (77°F). Actual production yield may vary between -10 and +10% of initial delivered lumens

** For more information on the IES BUG (Backlight-Uplight-Glare) Rating visit: www.ies.org/PDF/Erratas/TM-15-11BugRatingsAddendum.pdf

with Welded Base

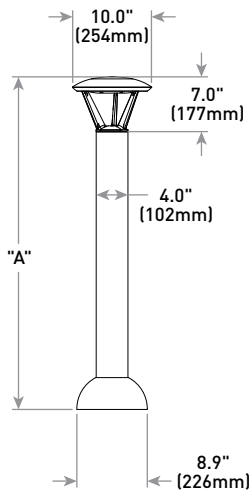

Model	Dim. "A"	Weight*
Pathway (P3)	36" [914mm]	17.9 lbs. [8.1kg]
Pathway (P4)	42" [1068mm]	18.6 lbs. [8.4kg]
Pedestrian (P8)	96" [2438mm]	28.4 lbs [12.9kg]

* Add 4.5 lbs. [2.0kg] for 347-480V

XSP Series

XSPW™ LED Wall Pack Luminaire



Making the Switch to LED Lighting an Easy Decision

OUTSTANDING Performance

Capable of replacing 70W - 175W Metal halide wall packs while reducing energy consumption up to 65%. The XSPW Wall Pack also provides improved lighting quality that contributes to creating a safe and inviting site.

MAXIMUM Lighting Value

The XSPW LED Wall Pack offers high-performance solutions for your site lighting needs at remarkably attractive price points. And it's backed by our industry leading 10-year limited warranty.

OPTICAL Precision

Featuring our NanoOptic® Precision Delivery Grid™ optic, the XSPW Wall Pack is designed for application-based performance that delivers light precisely where it's needed. The optical precision and efficient design help maximize energy savings.

EASY Installation

Designed with versatility in mind, the XSPW Wall Pack can seamlessly mount to a variety of configurations. Options for surface or through-wiring from top, side or rear makes replacing existing wall-mounted Metal Halide wall packs simple and easy.

Site Safety with Low Cost of Ownership.

Nothing speaks to security like reliability. The XSPW™ LED Wall Pack leverages Cree's innovative technology, developed for the industry-leading XSP street lights, offering customers a premier site lighting solution that incorporates exceptional thermal management with high-quality components and an unmatched paint finish, making Cree® LED solutions highly reliable. The result is an LED system capable of providing more than a decade of near maintenance-free service.

PERFORMANCE SUMMARY

Made in the U.S.A. of U.S. and imported parts

Utilizes BetaLED® Technology

NanoOptic® Precision Delivery Grid™ optic

DELIVERED LIGHT OUTPUT: 2,500 - 4,100 lumens

CRI: Minimum 70 CRI

CCT: 4000K (+/- 300K), 5700K (+/- 500K)

LIMITED WARRANTY: 10 years on luminaire / 10 years on Colorfast DeltaGuard® finish*

* See www.cree.com/lighting/products/warranty for warranty terms. Product specifications subject to change at any time. Visit www.cree.com/lighting to find the most up-to-date information.

CONSTRUCTION & MATERIALS

- Slim, low profile design
- Luminaire housing specifically designed for LED applications with advanced LED thermal management and driver
- Luminaire mounting box designed for installation over standard and mud ring single gang J-Boxes
- Luminaire can also be direct mounted to a wall and surface wired
- Secures to wall with four 3/16" (5mm) screws (by others)
- Conduit entry from top, bottom, sides, and rear
- Designed for easy through-wiring
- Designed for downlight applications only
- Exclusive Colorfast DeltaGuard® finish features an E-coat epoxy primer with an ultra-durable powder topcoat, providing excellent resistance to corrosion, ultraviolet degradation and abrasion

ELECTRICAL SYSTEM

- **Input Voltage:** 120-277V, 50/60Hz, Class 2 output
- **Power Factor:** > 0.9 at full load
- **Total Harmonic Distortion:** < 20% at full load
- Integral 10kV surge suppression protection standard

REGULATORY & VOLUNTARY QUALIFICATIONS

- cULus Listed for wet locations
- 10kV surge suppression protection tested in accordance with IEEE/ANSI C62.41.2
- Luminaire and finish endurance tested to withstand 5,000 hours of elevated ambient salt fog conditions as defined in ASTM Standard B 117
- Meets Buy American requirements within ARRA

PHOTOMETRY

XSPW™ LED Wall Pack - Type III - 42W

BXSPWA*3FC-US

Based on RESTL Test Report #: 2014-0018

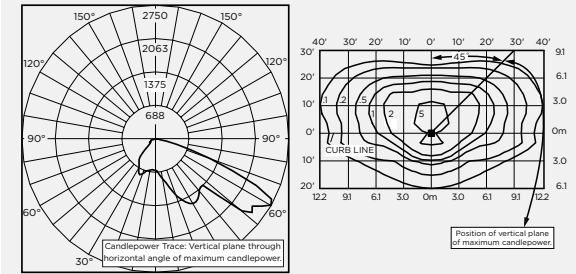

Initial Delivered Lumens: 4,187

Mounting Height: 10' (3.0m)
Initial Delivered Lumens: 3,819
Initial FC at grade

PHOTOMETRY

XSPW™ LED Wall Pack - Type III - 25W

BXSPWA*3FG-US

Based on RESTL Test Report #: 2014-0019

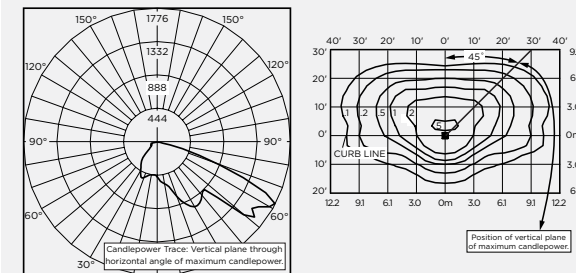

Initial Delivered Lumens: 2,692

Mounting Height: 10' (3.0m)
Initial Delivered Lumens: 2,529
Initial FC at grade

For exact photometric data please reference our available spec sheets and IES test results at: www.cree.com/lighting/xspwall

XSPW™

LED WALL PACK

Type II (2) & Type III (3)

- 2,529 lumens, 25W, 40K
- 2,722 lumens, 25W, 57K
- 3,819 lumens, 42W, 40K
- 4,109 lumens, 42W, 57K

Dimensions: L 9.3" x W 12.0" x H 3.8"



Black (T)

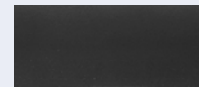

Bronze (Z)

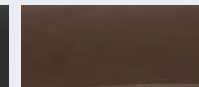

Platinum Bronze (B)



Silver (S)



White (W)

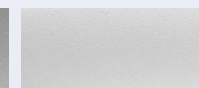

LED ACCENT BAND DETAIL

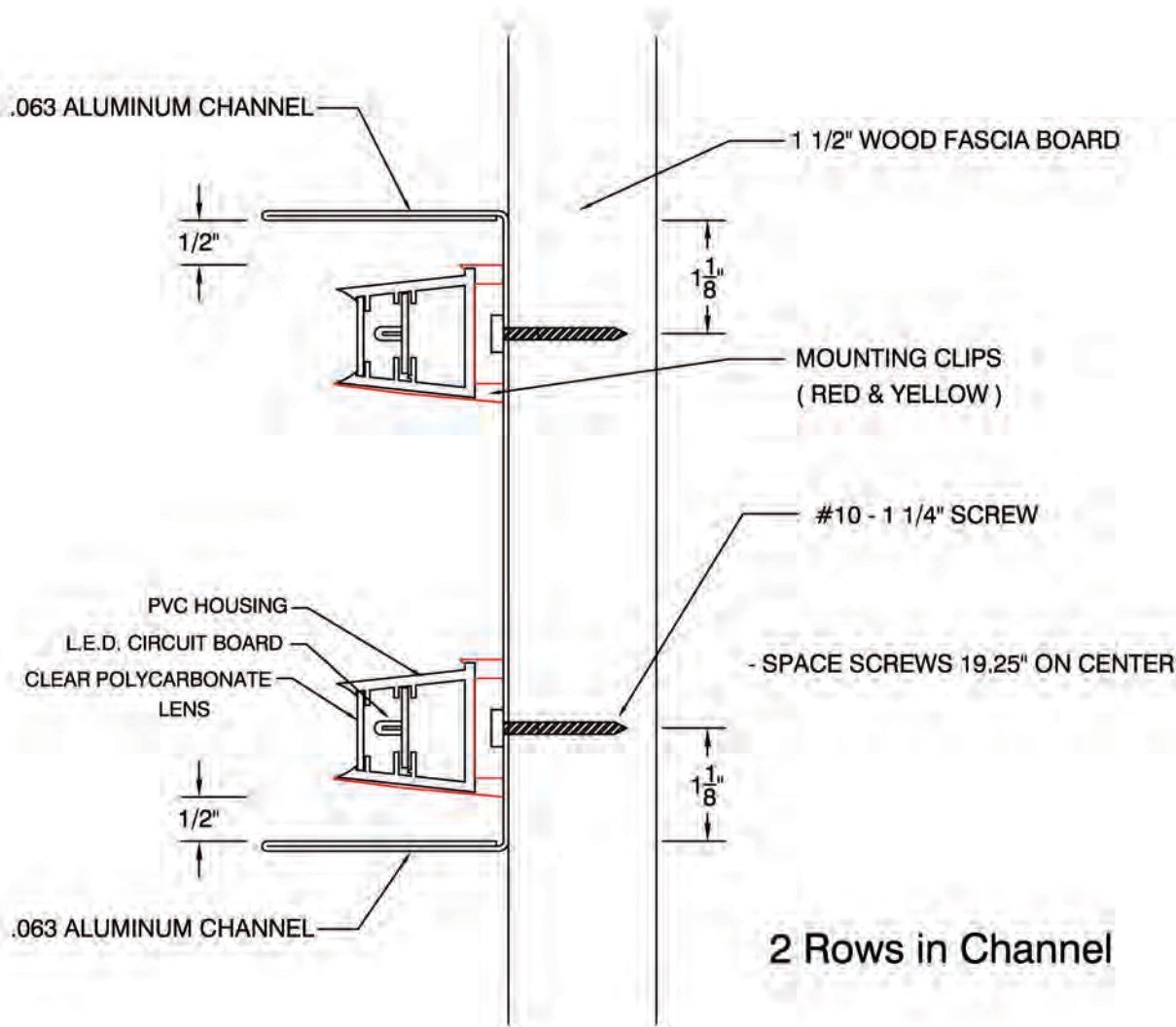

- GC 15
- GC 14
- GC 11M .10
- GC 11S .8
- GC 11SE .9

LED Channel -
 Painted Yellow Akzo Nobel
 #SIGN40062 with Gloss
 Clear Coat

Drawing # **021-10-2** Date: **8-12-13 Revised**





The NP is our most versatile LED up light, and is engineered to accommodate all aspects of your up lighting needs. By coupling the proper light intensity with one of the provided color filters, you can fine-tune the NP to beautifully enhance every landscape feature.

NP: Up Light

NUMBER OF LEDs:	1	3	6	9
HALOGEN LUMEN OUTPUT EQUIVALENT:	10 Watt	20 Watt	35 Watt	50 Watt
USEFUL LED LIFE (L70):	50,000 hrs avg	50,000 hrs avg	50,000 hrs avg	50,000 hrs avg
INPUT VOLTAGE:	10 to 15V	10 to 15V	10 to 15V	10 to 15V
VA TOTAL: (Use this number to size the transformer)	2.4	4.5	13.5	13.5
WATTS USED:	2.0	4.2	10.1	11.2
LUMENS PER WATT (EFFICACY)	25.4	31	31.8	31.1
MAX LUMENS:	52	135	279	357
CCT (Ra)	68.5	67.9	80.2	67.5

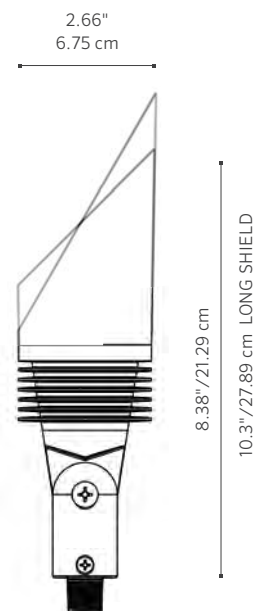



NP: Up Light

< LONG SHIELD

FACTORY INSTALLED OPTIONS: Order 1 + 2 (optional) + 3 + 4 (optional) + 5

Step	Description	Code
1	FIXTURE	NP
2	OPTIONAL ZD	ZD (Refer to the Luxor page in the Lighting Control section)
3	LAMP	1LED, 3LED, 6LED, 9LED (50,000 avg. life hours)
4	OPTIONAL SHIELD	LS (Long shield)
5	FINISH	WG, FW, AL, BZ, DG, WI, VF, SB, FB

EXAMPLE: NP-ZD-9LED-LS-DG = NP - ZD Option - 9LED Board - Long Shield - Desert Granite Finish

FIELD INSTALLED OPTIONS: Order Individually

Mounts	Beam Angle Lenses
Long Slot Spike (250015840000) 2.5" x 10"	LENS OPTIONS
SuperJ-Box (SJ-XX**) 2.5" x 12"	1LED 3LED 6/9LED
Post Mount (PM-XX**) 2.5" x 13"	Diffuser 18° (preassembled) 770600 771300 771600
	Flood Lens 30-32° (1 notch) 1LEDFLENS 3LEDFLENS 9LEDFLENS
	Wide Flood Lens 56-58° (2 notches) 1LEDWFLENS 3LEDWFLENS 9LEDWFLENS

EXAMPLE: 250015840000 = Long Slot Spike

PHOTOMETRICS:

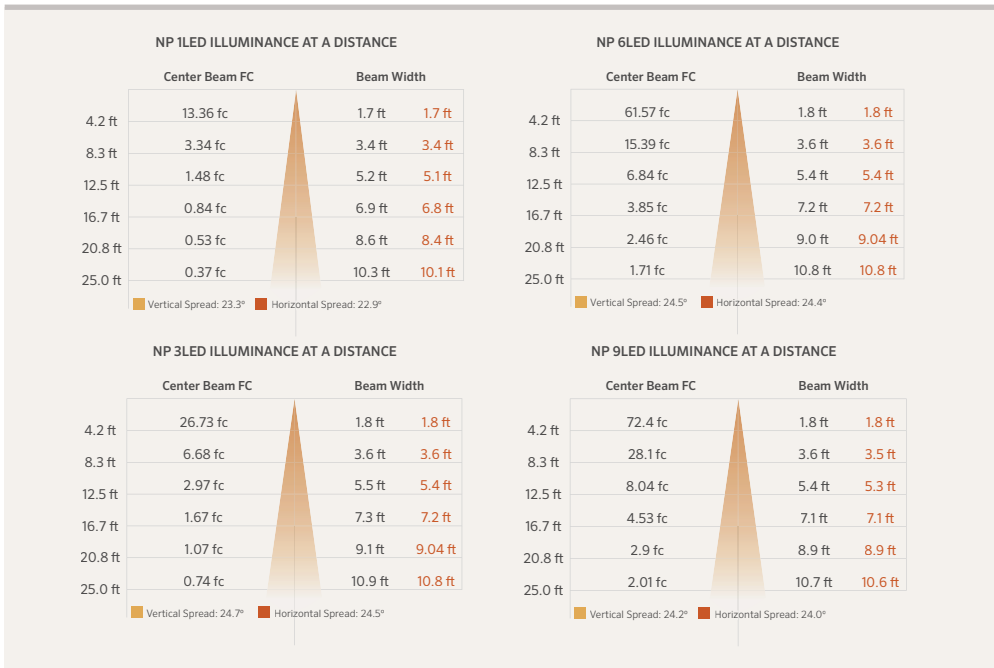

POWDER COAT

	WG = White Gloss
	FW = Flat White
	AL = Almond
	BZ = Bronze Metallic
	DG = Desert Granite
	WI = Weathered Iron
	VF = Verde Speckle
	SB = Sedona Brown
	FB = Flat Black

The NP includes choice of LED board, choice of finish, 4 ft lead wire and a Super Slot Spike.

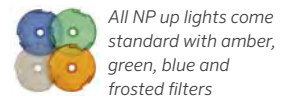

All NP up lights come standard with amber, green, blue and frosted filters

Beam angle is calculated using LM-79 method for SSL Luminaires: "Beam angle is defined as two times the vertical angle at which the intensity is 50% of the maximum."

** Denotes finish code





Versatile up light or directional path light The clean lines of the RW complement both commercial and residential landscapes. The RW offers adjustable beam spread and soft illumination to wash walls and create a gentle glow. Perfect for subtly accenting architectural elements or textural plant details. Made of die cast aluminum; zoneable with the Luxor controller.

RW: Path/Up Light

NUMBER OF LEDs:	1	3	6	9
HALOGEN LUMEN OUTPUT EQUIVALENT:	10 Watt	20 Watt	35 Watt	50 Watt
USEFUL LED LIFE (L70):	50,000 hrs avg	50,000 hrs avg	50,000 hrs avg	50,000 hrs avg
INPUT VOLTAGE:	10 to 15V	10 to 15V	10 to 15V	10 to 15V
VA TOTAL: (Use to size the lighting controller)	2.4	4.5	13.5	13.5
WATTS USED:	2.0	4.2	10.1	11.2

PATH LIGHT

LUMENS PER WATT (EFFICACY)	49.92	64.98	51.23	52.79
MAX LUMENS:	99.66	264.66	411.28	583
CRI (Ra)	82.80	83	82.90	82.90

UP LIGHT

LUMENS PER WATT (EFFICACY)	51.32	64.35	57.28	54.10
MAX LUMENS:	102.02	268.02	459.70	551.50
CRI (Ra)	82.70	83.20	83	82.60

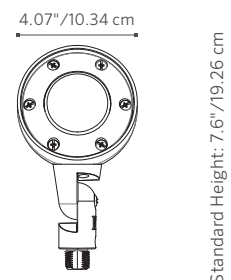
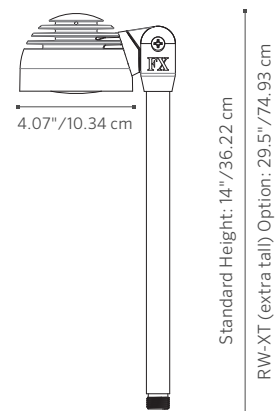



RW: Path/Up Light

FACTORY INSTALLED OPTIONS: Order 1 + 2 (optional) + 3 + 4 (optional) + 5

Step	Description	Code
1	FIXTURE	RW
2	OPTIONAL ZD	ZD (Refer to the Luxor page in the Lighting Control section)
3	LAMP	1LED, 3LED, 6LED & 9LED (50,000 avg. life hours)
4	OPTIONAL RISER HEIGHT	8R, 12R, 18R, 24R, 30R, 36R (in inches)
5	FINISH	WG, FW, AL, BZ, DG, WI, VF, SB, FB, SV

EXAMPLE: RW-ZD-9LED-18R-BZ = RW - ZD Option - 9 LED Board - 18" Riser - Bronze Metallic Finish

FIELD INSTALLED OPTIONS: Order Individually

Mounting Options	
Long Slot Spike (250015840000) 2.5" x 10" Included ▶	<p>Long Slot Spike Super Slot Spike Super J-Box XX** Post Mount XX**</p>
Super Slot Spike (753900) 2" x 10"	
SuperJ-Box (SJ-XX**) 2.5" x 12"	
Post Mount (PM-XX**) 2.5" x 13"	

EXAMPLE: 753900 = Super Slot Spike

POWDER COAT

	WG = White Gloss
	FW = Flat White
	AL = Almond
	BZ = Bronze Metallic
	DG = Desert Granite
	WI = Weathered Iron
	VF = Verde Speckle
	SB = Sedona Brown
	FB = Flat Black
	SV = Silver

PHOTOMETRICS:

PATH LIGHT

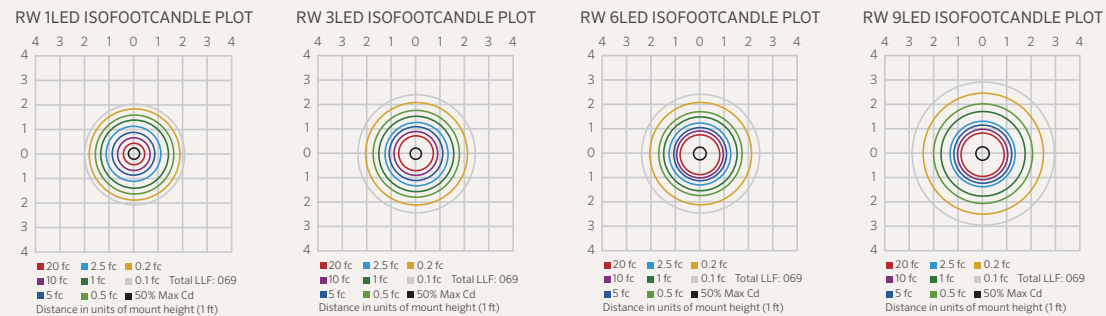

The RW includes your choice LED boards, choice of finish, 4 ft. lead wire and a Long Slot Spike.

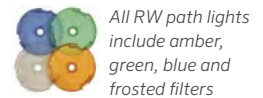

** Denotes finish code



UP LIGHT

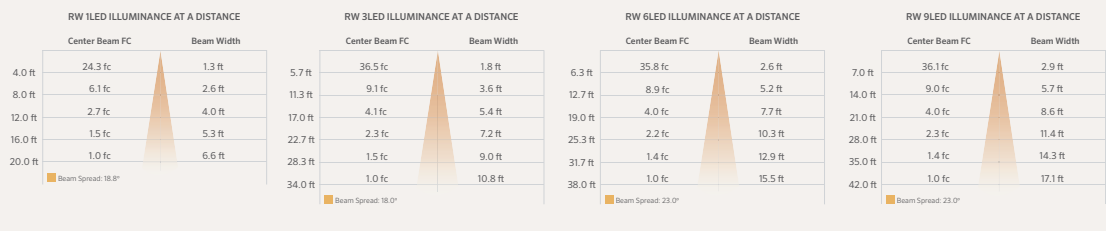

The RW includes your choice of LED board, riser size, finish, 4 ft. lead wire and a Long Slot Spike.

FXLuminaire®

LUXOR® ZD/ZDC POWER CONTROLLER

LANDSCAPE LIGHTING



LUXOR[®] ZD

Controller

Create any ambiance. Anytime.

When Luxor ZD controls an LED landscape lighting system, lights don't simply turn on and off. They come alive. Luxor offers both zoning and dimming capabilities that provide virtually limitless design possibilities. Zoning allows lights to be programmed into preset themes, which can be activated for special occasions such as parties, or activities such as barbecuing. Dimming allows lights to automatically emit any desired dimming percentage anytime, anywhere within a system. For example, Group 1 can be set to 100% illumination at 7:00 p.m., and automatically dim to 60% at 9:00 p.m. Groups 2 and 3 can be set to their own percentages and adjusted throughout the night as lighting needs change for those areas.

Luxor's proprietary ZD Technology[®] makes it the most versatile, affordable, and easy-to-use zoning and dimming control system ever created. It's the clear choice for the professional designer and the most discerning clients.



LUXOR® ZD FEATURES & SPECIFICATIONS

Main Features

- Up to 250 independently adjustable lighting groups can be created
- All groups can be turned on independently and dimmed from 1-100%
- User interface includes a full color LCD display for easy setup, maintenance and adjusting of groups
- Uses event-based scheduling, which allows a single group of lights to change dimming percentages throughout the night
- Optional iOS or Android control with the Wi-Fi module accessory (sold separately)
- Wirelessly assign fixtures to groups with the LAM accessory* (sold separately)

Detail Features

- Fully removable facepack
- Simple two-wire configuration for easy installation and adjustment
- Fixture addressing takes place on the front of the facepack for easy access
- No matter where a light is within a system, it can communicate with the transformer to receive its schedule, dimming percentage, and group
- Astronomical Timing Function with Map Placement
- Available in 150 & 300 Watts
- Stainless Steel or Matte Gray powder coated cabinet finish options

Astronomical Timing

Astronomical timing is one of the best ways to turn a lighting system on and off without the need of a photocell. At FX Luminaire® we created an easy-to-use map placement feature that places your location. No more numbers, zip codes, or manuals to read – just point to your location.

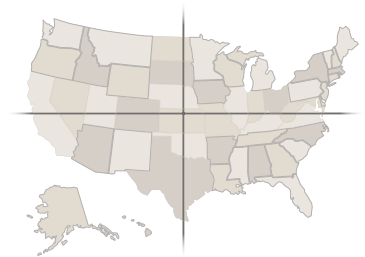

Event-Based Timing

No longer is a system just on or off. You can program Luxor to set specific dimming percentages based on time. So when you arrive home at 6 p.m. and it's dark outside, you could have Luxor turn on your path lights before you arrive, then dim them at a specific time. The possibilities are endless.

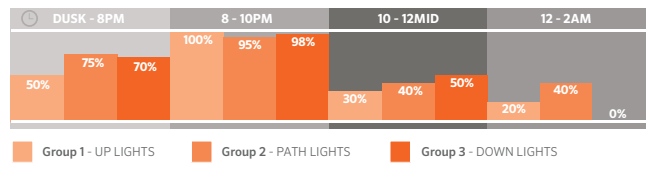

Chassis Diagram

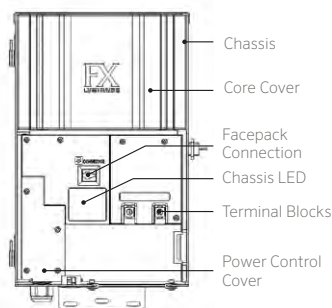

Facepack Diagram

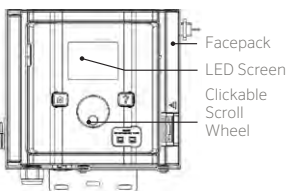

Accessories

LSAT300	Satellite Luxor Unite
WIFIMOD	Wi-Fi module with antenna
LANMOD	LAN Module for cat5 connection
LAM	Light Assignment Module for iOS & Android Smartphones and tablets*
LUXORFPMNT	Luxor Facepack Mount

*Not all iOS & Android devices will work with the LAM,

TECHNICAL SPECIFICATIONS

Model	150 or 300 watt
Finishes	Stainless Steel or Matte Gray powder coat
Depth	5" / 12.7 cm
Width	8" / 20.3 cm
Height	13" / 33 cm

LUXOR[®] ZDC

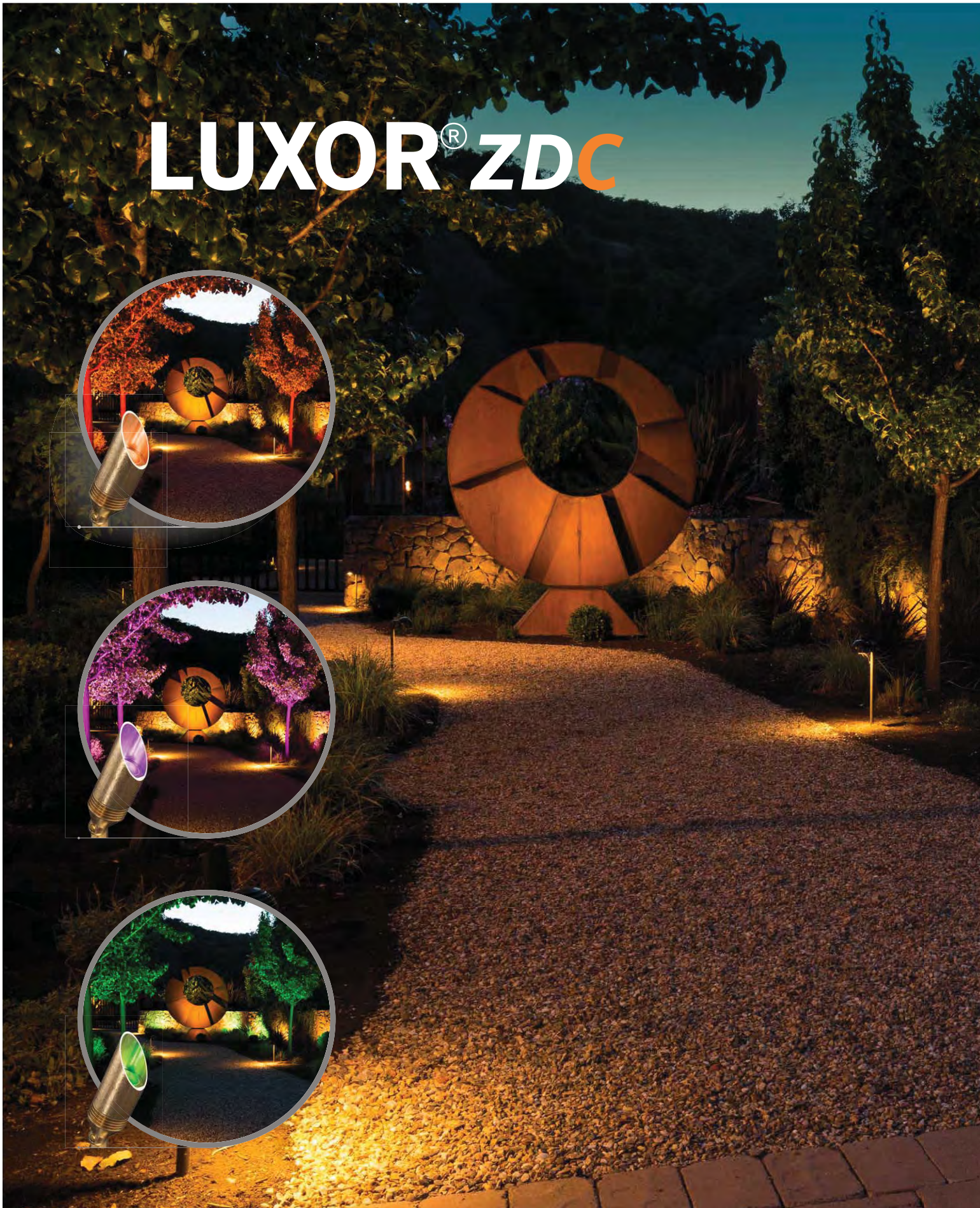

Now Luxor plays well with others

ZD MR-16

Replacement lamp

The ZD MR-16 is a convenient high-quality drop-in LED replacement lamp that converts incandescent fixtures to energy-efficient LED fixtures. When connected to a Luxor ZD or ZDC controller, the ZD MR-16 adds zoning, dimming, and Wi-Fi control capabilities to any brand of low voltage lighting fixture.



LUXOR CUBE

With the New LUXOR® CUBE, the Luxor can control, zone, and dim almost any brand of dimmable 12V or 110V light fixtures. It can also control any item that uses a relay input like gates and pond pumps. That makes it the ultimate system for outdoor home automation.



Luxor system control

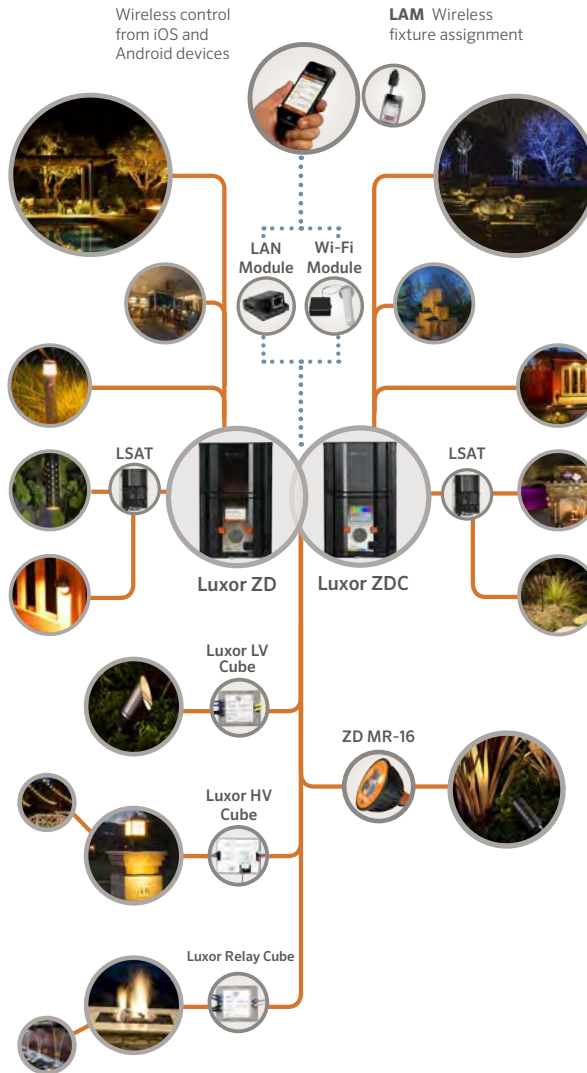

FXLuminaire.

LUXOR® ZD/ZDC POWER CONTROLLER



LUXOR® ZD

LUXOR® ZDC



Create any Ambiance. *Anytime.*

When Luxor® ZD controls an LED landscape lighting system, lights don't simply turn on and off. They come alive. Luxor offers both zoning and dimming capabilities that provide virtually limitless design possibilities. Zoning allows lights to be programmed into preset themes, which can be activated for special occasions. Dimming allows lights to automatically emit any desired intensity anytime, anywhere within a system.

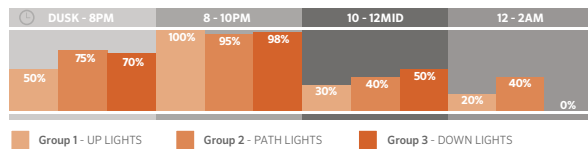

Zoning & Dimming + *Color*

The Luxor® ZDC provides the ability to create 30,000 colors using RGBW LED technology. With the ZDC, custom colors can be created for outdoor holiday displays, team spirit themes, company colors, or special events. Color temperatures can be adjusted to match vegetation and architecture, offering unique landscape looks throughout the year.

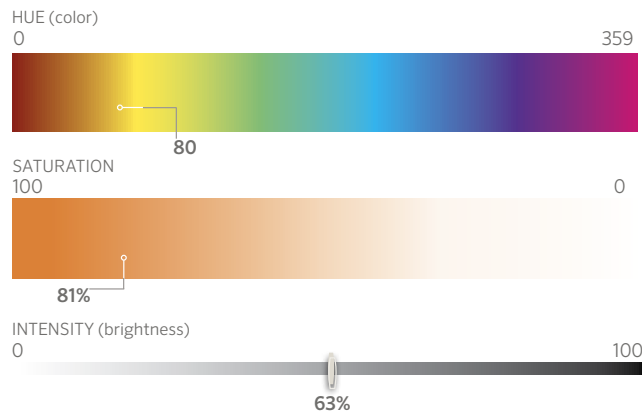

LUXOR® Wi-Fi Control

INTRODUCING Wi-Fi CONTROLLED LUXOR ZD

The Luxor Wi-Fi system is the next step in control for landscape lighting, adding onto the already versatile and limitless capabilities of the Luxor controller. Zoning, dimming and color are now controllable with iOS and Android devices for easy on-site control. All programs remain independent within each controller, allowing for maximum automatic control.

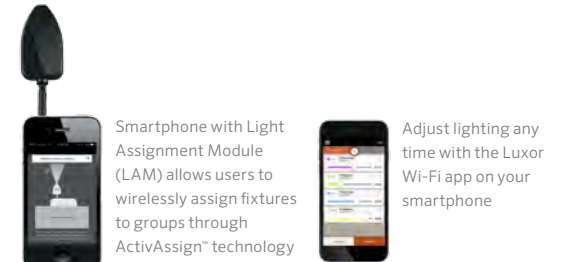

LUXOR LINKING

Luxor Linking provides the ability to control a multiple controller site while maintaining a single point of control. Link up to nine Satellite controllers to one Primary controller. Once linked, the Primary Luxor controls all groups, programs and themes.

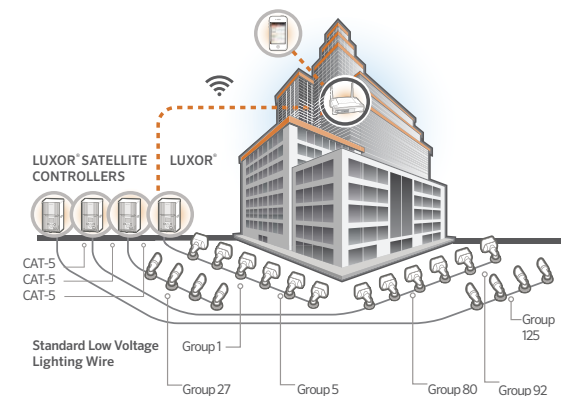



11525 W. North Ave. Suite 1b Wauwatoosa, WI 53226
(414)-476-1204

email: mdavis@insitelandscape.com
www.insitelandscape.com