

CITY OF MILWAUKEE
Tom Barrett, Mayor

Common Council

Ald. Willie Hines, *President*
Ald. Ashanti Hamilton
Ald. Joe Davis
Ald. Mike D'Amato
Ald. Robert Bauman
Ald. Jim Bohl
Ald. Michael McGee
Ald. Willie Wade
Ald. Robert Donovan
Ald. Robert Puente
Ald. Michael Murphy
Ald. Joe Dudzik
Ald. Jim Witkowiak
Ald. Terry Witkowski
Ald. T. Anthony Zielinski

Business Improvement District #2
Board of Directors

Einar Tangen, *Chair*
Ron San Felippo, *Vice-Chair*
Michael DeMichele, *Secretary*
Michael Gardner, *Treasurer*
Frank Krejci
Scott Sampson
Greg Uhen
Robert Monnat
Dick Wright

DCD Review Group

John Hyslop
Vanessa Koster
Michael Maierle
Karen Mierow
Greg Patin
Michael Wisniewski

City Planning Commission

R. Gray Mitchem, *Chair*
Patricia Torres, *Vice Chair*
Michael Dawson
Douglas Drake
Larri Sue Jacquart
J. Allen Stokes
Gaurie Rodman

Department of City Development

Rocky Marcoux, *Commissioner*
Martha Brown, *Deputy Commissioner*
Robert Greenstreet, *Planning Director*
John Hyslop, *Assistant Planning Director*

HTW Architectural Review Board

Alderman Robert Bauman, *Chairman*
Einar Tangen, *Chair, BID #2*
Michael DeMichele, *BID #2*
James Piwoni, *AIA*
Matthew Jarosz, *HPC*
Doug Stoneman, *resident*
Tracy Williams, *DCD*
Chris Rute, *ARB Consultant*
Nancy O'Keefe, *Board Secretary*

Consultant Team

James Piwoni, *AIA Author / Editor*
in association with
American Design Inc., *Mapping*
Jennifer Fletcher, *Graphic Layout*
Ryan Schulze, *Graphic Editing*

Historic Third Ward Association
Board of Directors

Ron San Felippo, *President*
Chuck Ward, *Vice-President*
Doug Stoneman, *Secretary*
Mike Gardner, *Treasurer*
Stephanie Sherman, *At Large*
Dennis Barthenheier
Larry Compton
Angie D'Amato
Sue Darrow
Michael DeMichele
Karen Elert
Don Ellingsen
Bill Jennaro
Clarke Johnson, *ex-officio*
Carl Komassa
Christopher Libby
Mark Lawson
Mike Mooney
Beth Nichols, *ex-officio*
Sue Riordan
Scott Sampson
Don Smiley
Sue Strauss
Einar Tangen
Greg Uhen
Andrew Wadsworth

Special Thanks to David Reed and Douglas Ryhn for their contributions to the original guideline document which has provided the criteria for ARB decisions over the past decade.

table of contents:

Introduction

How to use these Guidelines

Urban Design Characteristics	3	Buildings Within the Urban Framework	25
<u>Spatial Organization of the District</u>	<u>6</u>	<u>Character</u>	<u>28</u>
Legal Boundaries	6	Demolition	28
Visual Boundaries	7	New Building Types	29
Streets & Blocks and Development Patterns	8	Variety	30
Patterns of Use	10	Design Themes-Adaptive Reuse	32
<u>Design Principles of Urban Spaces</u>	<u>12</u>	Design Themes- Industrial Aesthetic	33
Street Space Enclosure	12	Design Themes- Urban Residential	34
Continuity of Building Edge	13	Design Themes- Urban Mixed Use	35
Cross Section of Streets	14	Design Themes- Low Rise Reuse	36
Social Life of the Street: Structure of Spaces	16	Signature Sites	37
Social Life of the Street: Uses	18	Street Facades	38
Social Life of the Street: Entrances	19	Diversity	39
Social Life of the Street: Entrances-Residential	20	Riverfront Facades	40
		<u>Design Composition</u>	<u>42</u>
Parking	22	Base, Middle, Top	42
		Roofs	44
Parking: On Street	22	Silhouette	45
Parking: Off Street	23	Proportion	46
		Rhythm	47
		Solid and Void	48
		Scale	49
		Neighboring Structures	50
		<u>Form</u>	<u>52</u>
		Infill Sites	52
		Facade Height	53
		Back Facades	54
		Exposed Sides of Buildings	55
		Balconies	56
		Penthouses	58
		Vertical Facade Extensions	59
		Renovations and Additions	60
		Mechanical and Safety Equipment	62

Preservation of Neighborhood Qualities **64**

Building Details 66

Windows and Window Openings 66

Doors and Door Openings 68

Garage Doors 69

Storefronts 70

Security Grills and Gates 73

Building Signs 74

Sidewalk Signs 80

Other Signs 81

Canopies, Marquees, and Awnings 82

Exterior Building Lighting 84

Building Materials 86

Surface Treatment and Finishes 86

Ornamentation and Trim 87

Painting 88

Color 89

Ghost Signs 90

Wall Murals and Public Art 91

Bibliography **92**

Appendix **94**

Riverwalk Elements 94

Photo Credits 98

City of Milwaukee Ordinance 200-61 99

Architectural Review Board

publication information:

The Historic Third Ward Neighborhood Design Guidelines:
James Piwoni, AIA

Design Guidelines for the Historic Third Ward, Milwaukee
James Piwoni, David Reed, and Doug Ryhn

Abstract

The Historic Third Ward is located immediately south of Milwaukee's downtown. The area was originally a thriving, tightly packed urban neighborhood and the city's wholesaling and warehousing district. After a period of economic decline, change is taking place in the district through the addition of new buildings and the rehabilitation of existing buildings. Design Guidelines for the Historic Third Ward Neighborhood seeks to give a direction to the change that will allow the essential historic character of the District to be preserved. The guidelines provide property owners and developers within the BID area, direction towards maintaining the architectural integrity of their buildings and contributing to the overall historic character of the District. They also present a framework for architects to rehabilitate existing buildings or design new buildings with an awareness of the special characteristics of the historic neighborhood.

Each design guideline is elaborated in the text and illustrated through photographs and diagrams showing unacceptable and acceptable solutions.

The revised edition of these guidelines was commissioned and published by the Historic Third Ward Association, Inc., along with the City of Milwaukee Business Improvement District No. 2 Board and the the City of Milwaukee Department of City Development.

The original guidelines were co-funded with the assistance from the National Park Service, U.S. Department of the Interior, under provision of the National Historic Preservation Act of 1996, as amended. Historic Preservation grants-in-aid are administered in Wisconsin in conjunction with the National Register of Historic Places program by the Historic Preservation Division of the State Historical Society of Wisconsin. However, the contents and opinions contained in this publication do not necessarily reflect the views or policies of the National Park Service or the State Historical Society of Wisconsin.

Introduction and Background to the Study

This revised document integrates additional design criteria concerning new construction on open land expanding from the predominant preservation objectives of the original Design Guidelines for the Historic Third Ward District. It presents guidelines that address the urban character of the District, the issues surrounding buildings within the urban framework, and the issues related to preservation of the building character. It does not usurp State building codes or City ordinances but supplements them.

The City of Milwaukee Common Council approval of the Business Improvement District No. 2 in 1988 authorized the BID Board to establish a design review process for projects within its boundaries seeking building permits.

In the summer of 1989 the Historic Third Ward Association, Inc. together with the City of Milwaukee Business Improvement District No. 2 Board, the City of Milwaukee Department of City Development, and the Historic Preservation Division of the State Historical Society of Wisconsin, sought assistance from the urban design team of James Piwoni, David Reed, and Doug Ryhn.

To establish the criteria for evaluating proposals, the team recommended a participatory process to encourage input into the process for the property owners, to facilitate an understanding of the guidelines as they developed, and to gain voluntary support for the guidelines. The participatory approach yielded a document with 62 original design guidelines. The report was accepted by the funding organizations. In 1990 the Common Council, City of Milwaukee, adopted the guidelines as the basis for determinations of a newly formed Third Ward Architectural Review Board, that can issue "Certificates of Appropriateness".

Process of Revision

Since their adoption, much has been learned by the Architectural Review Board about the strengths and deficiencies of the original Guidelines. Inevitably, revisions and amendments become necessary as changes occur. The most recent year long process of revision and update culminating in this document, recalls much of the fourteen years of experience the ARB has had reviewing proposals. It concurrently considered the next decade or two anticipating architectural and urban design issues evolving from and coordinated with the simultaneous preparation of the Third Ward Neighborhood Comprehensive Plan.

The design guidelines presented in this report were again prepared using a participatory approach. ARB work sessions were scheduled. These review board meetings were publicized as meeting agenda items. All meetings are open to the public.

An average meeting would include eight to ten participants. During each session the consultant presented several guideline issues. These were thoroughly discussed by all participants, amended, qualified, and rewritten where necessary.

During the weeks between ARB sessions, analysis and graphic material was prepared to articulate the new guidelines and to prepare materials explaining those issues.

A great deal of productive interaction occurred during the work sessions. Special appreciation is extended to those people who gave of their time to participate in the process.

This process of updating also triggered a revision of the enabling City ordinance governing the ARB. A copy of that adopted new ordinance is included in the Appendix.

What are Design Guidelines?

Fire precaution regulations, daylight standards, building setback lines, and other codes have a major, yet incidental, impact on the design of the built form, but are not conceived of or drawn up with this end in mind. Within codes specific design controls are minimal. Where they exist they are limited and work on the assumption that aesthetics are a matter of individual taste. Bad design is condemned but undefined.

It is the purpose of the guidelines presented in this publication to provide everyone involved in the rehabilitation and design of buildings with a clear set of parameters concerning design in the Third Ward Neighborhood. For developers, planners, and designers, these guidelines explain the context within which design changes should take place and outline the District's significant characteristics. For property owners, these guidelines help to ensure that future design changes in the District will enhance the value of existing property. For the community, these guidelines increased the chance that the local urban environment will be maintained and enhanced for future generations.

Whether design control should operate at all and, if so, to what extent continues to be a source of considerable debate. This debate will no doubt continue. However, many from both sides of the argument are aware of the deteriorating quality of the urban environment and see some form of intervention as both necessary and desirable.

The challenge is to determine the amount and the scope of intervention. The guidelines presented in this publication seek to achieve this balance for design in the expanding Third Ward neighborhood of Milwaukee.

spatial organization of the district the principles of urban design

"One building standing alone in the countryside is experienced as a work of architecture, but bring half a dozen buildings together and an art other than architecture is made possible." Gordon Cullen: Townscape. London, Architectural Press, 1961.



Early Third Ward Neighborhood

The guidelines presented in this publication are divided into three sections, each related to different levels of proposed change:

Section One: Urban Design Characteristics

This section considers change at the largest scale. It is aimed at an audience of developers, planners, and city officials and as such is sub-titled *Planning and Design Guidelines for the Development Team*.

Section Two: Building within the Urban Framework

This section focuses on changes to individual structures where State law requires an architect to certify construction documents. It is subtitled *Technical Design Guidelines for the Architect*.

Section Three: Preservation of Building Character

This section addresses incremental change occurring at the scale of building sub-systems or components where the owner

may choose not to engage the service of an architect but deal directly with a contractor. This section is subtitled *Owner's Guidelines for Minor Building Improvements and Maintenance*.

Format:

Each guideline is expressed in general terms in bold face text. This general statement is then qualified and explained in written and graphic form. The text generally follows a format of describing the existing conditions, restating or redefining the guideline, and explaining the implications of the guideline and its resulting impact on the District.

Language:

Work session participants generally agreed that guidelines should be stated in as strong a language as possible to emphasize the importance of each.

Introduction.

The Historic Third Ward is a vital historic area containing a large concentration of late 19th and early 20th century industrial and warehousing buildings. It is located immediately to the south of Milwaukee's downtown, although separated from it by the elevated I-794 expressway. The District is bounded on the east by Lake Michigan and the Summerfest grounds and fronts on to the Milwaukee River to the west and south.

The major concentration of historic buildings is in the area west of Milwaukee Street. While several individual buildings have outstanding architectural quality, it is the overall ensemble which gives the Third Ward its special identity. It is the concentration of the older buildings, the relationships between the buildings and the overall environment, the strong definition of the streets, and its cultural landscape that give the Third Ward its special character and unique identity within the region.

Over the past decade there has emerged a new sense of purpose and enthusiasm in the Historic Third Ward. During this time many older buildings have been rehabilitated for office, housing, commercial, and other new activities, and a property owner and merchants organization, the Historic Third Ward Association, Inc., has successfully promoted the revitalization of the area.

Many of the other buildings outside the historic district are structurally sound but will require rehabilitation and remodeling to accommodate new uses and to make a positive contribution to the emerging vitality.

Land uses within the Third Ward Neighborhood are varied. Although industrial use and warehousing activities once

predominated, retail and commercial use is expanding, particularly along the groundfloor frontages of Water Street, Broadway, and to some extent, along Milwaukee Street. Upper floor space in many buildings has been converted to office use and housing. New, large-scale mid-rise housing developments have redefined entire blocks east of Milwaukee Street, along Jefferson, Jackson, and Erie Streets.

While the Historic Third Ward is essentially fully developed, there are several vacant or under-utilized building sites scattered throughout the District. However, to the east of Jackson Street, the land is primarily used for surface parking in relation to the Summerfest grounds. This large continuous piece of vacant usable land (approximately 15 acres), is the former Coachyard land.

The District is now at a critical juncture. For development to take place, future growth and change must be introduced in a sensitive and orderly manner that is compatible with the District's past and with its extensive historic legacy.

The following design guidelines address the issues related to change in the urban fabric of the District and the urban design issues at the largest scale. They are intended to help developers, planners, and city officials make decisions that affect the whole District. They are, therefore, necessarily broad in scope but address elements related to the design of the urban fabric of the District that have given the area such a distinct character. These guidelines seek to preserve this character and to learn critical lessons from it to influence the quality and shape of new development in the area.

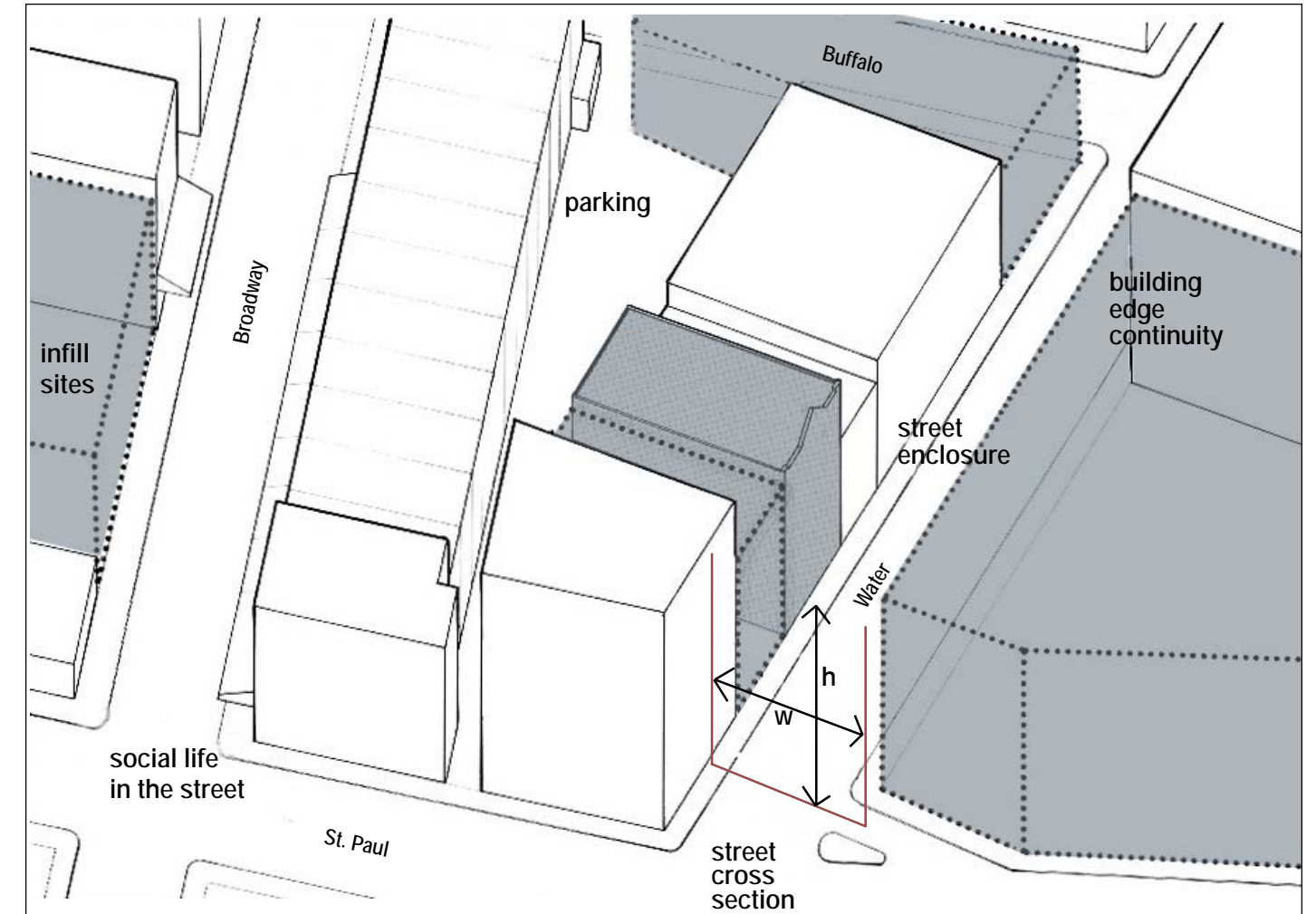

Urban Scale Principles

SPATIAL ORGANIZATION OF THE DISTRICT

legal boundaries



HISTORIC BUILDING SURVEY

This Historic Third Ward District, a designated historic district listed in the National Register of Historic Places, defines the core area of historic buildings.

Three other overlapping districts define administrative areas that are significantly related. Each has different boundaries and has particular characteristics associated with its function.

The Business Improvement District (BID) was established as a legal entity in 1988 capable of generating revenue by assessing a fee to all property owners throughout the District. The objective of the BID Board is to direct the expenditure of these revenues for the management and promotion of the District as a whole.

The Tax Incremental Financing Districts (TID) 11 and 34 were established in 1988 and 2000 as mechanisms whereby new public improvements in the District are paid for by new tax revenues that result in part from new private investments stimulated by the public improvements.

In 1988, TID 11 financed the Historic District streetscape improvements. In 2000, TID 34 financed construction of the Riverwalk's first phase from Clybourn to the Water Street Bridge. At the time of this edition, other TID's are under consideration. The most recent TID, #56, was established in 2004.

SPATIAL ORGANIZATION OF THE DISTRICT

visual boundaries



NEIGHBORHOOD GATEWAYS

Design Guideline: Reinforce existing strong visual edges of The Historic Third Ward Neighborhood.

Design Principle: Urban neighborhoods with a distinct image are often defined by clear boundaries, edges marked with entry points, urban gateways.

The Historic Third Ward is bounded on three sides by very strong physical boundaries that define and give image to the District. To the north, the I-794 freeway separates the District from the downtown. To the west and south, the Milwaukee River separates the District from the Menomonee River Valley and Walkers Point. These cognitive boundaries present a strong image that gives clear identity to the Historic Third Ward.

Routes into the District from these surrounding areas are marked by bridges over the river or underpasses beneath the freeway that reinforce the experience of entering the District.

To the east, however, the vacant coach yards and industrial areas form a poorly defined subarea adjacent to the historic district. New development in this area should extend the urban character of the Historic Third Ward to the freeway, and continue to define the District. It should also reinforce existing boundaries, and emphasize the gateways to the neighborhood.

SPATIAL ORGANIZATION OF THE DISTRICT

pattern of streets and blocks



Design Guideline: In general, the existing pattern of streets and blocks should be maintained and extended

Design Principle: Street layout fundamentally guides the scale of future development and can ascribe cultural significances by variation within the pattern of streets and blocks.

Historically, the scale of development within the District has been constrained by the size of a city block and available building technologies. The railway coachyards, however, were never subdivided into city blocks.

Recent development practices have permitted larger buildings that either block existing streets or occupy an area larger than one city block.

Two rejected proposed developments, the Italian Community Center scheme by Bonifica and the Baseball Stadium proposal, were multi-block developments of a scale that would have dramatically contrasted with the scale of the Historic Third Ward. In order to consistently extend the scale of the Historic District, existing streets should be maintained and no further encroachment of buildings into streets should be permitted.

New streets should expand the city grid to the east up to the freeway to create a pattern of streets and blocks that is generally consistent with the historic urban fabric. This is a fundamental step in guiding the scale of future development.

development pattern

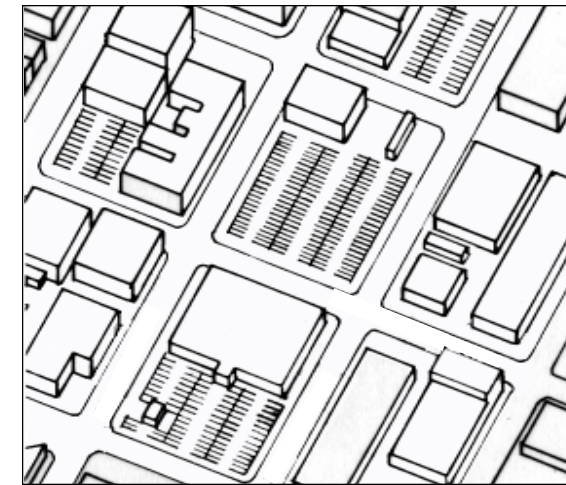

Existing Surface Parking

Undesirable Low Rise Development

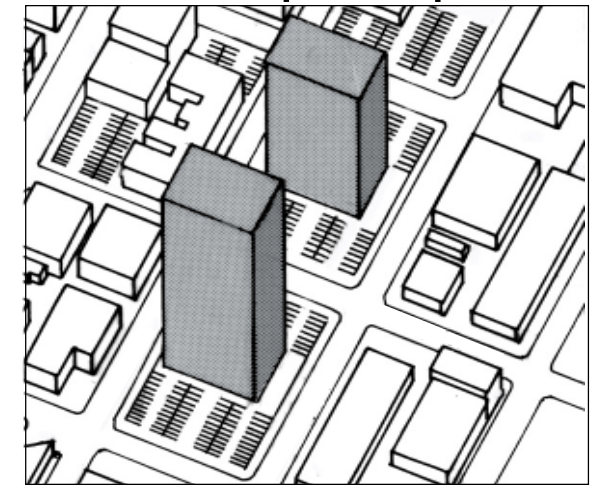
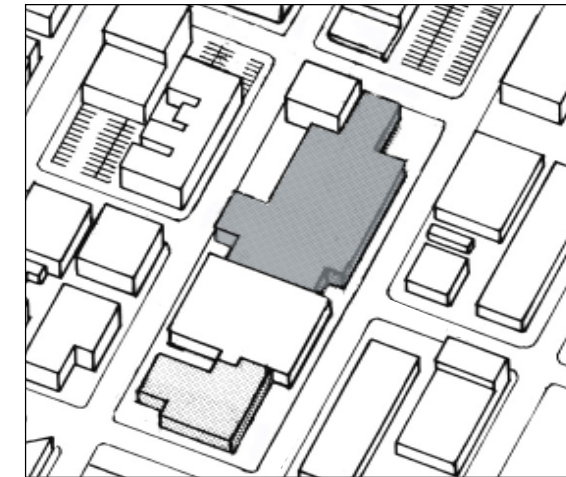

Undesirable High-Rise Development

Desirable Pattern of Mid-Rise Development

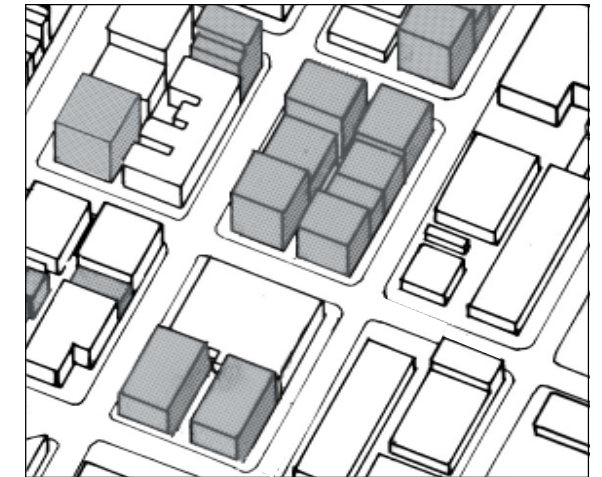

Design Guideline: As development proceeds, vacant sites should be filled with mid-rise buildings, including parking structures.

Design Principle: The height of new buildings should not vary too much from the predominant height of buildings in the Historic District.

Typically the pattern of building within the District has been mid-rise structures occupying the majority of the city block. Urban attrition has resulted in major gaps within the urban fabric. These gaps have afforded the opportunity to inject needed surface parking lots into the area. New industrial building resulting from changing transportation patterns and freeway access to the area cleared out existing development and established a pattern of large single level industrial buildings with adjacent surface parking areas.

The decline of the rail network further added to the attrition and created the large vacant area of the Coachyards (Map, p 10).

This suburban industrial park land use pattern and resultant building type is not the highest and best use, and is inappropriate in this urban location and out of character with the evolving neighborhood.

Just as low single-story development must be avoided so must the prevalent urban pattern of high-rise development with surrounding surface parking. Where possible parking should be concentrated in multilevel structures to fill voids along streets in the neighborhood

SPATIAL ORGANIZATION OF THE DISTRICT

patterns of use

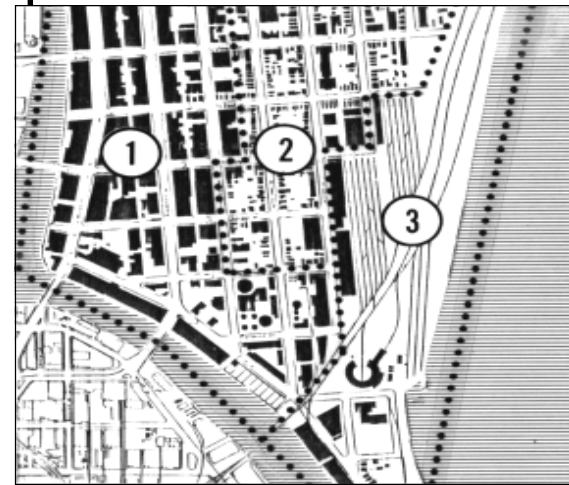

Historic Pattern of Use

1970's Use of Buildings

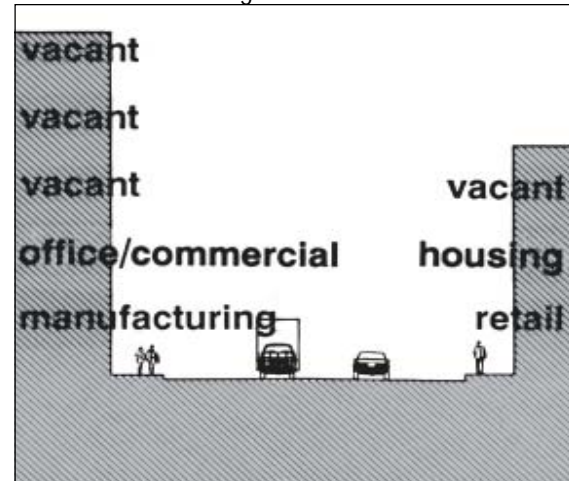

- Key:
1. Wholesale/ Manufacturing
 2. Italian Neighborhood
 3. Rail Yards
 4. Light Manufacturing
 5. Vacant Coachyards
 6. Henry Meier Festival Grounds
 7. Mixed Uses

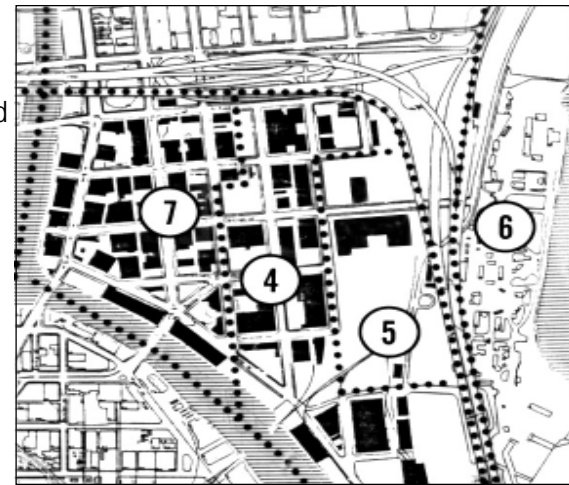

1970's Pattern of Use

Proposed Mixed Use

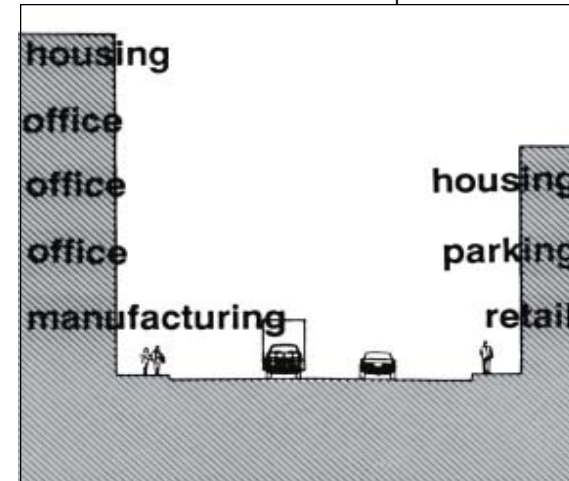

Design Guideline: Multi-story, mixed use development is preferred throughout the District. Single story, single use development in the district is prohibited.

Design Principle: A mix of compatible land uses brings added vitality, amenity, and often security to the streets of urban neighborhoods

The Third Ward has been characterized by a mix of uses. These have included manufacturing, warehousing, wholesale distribution, industrial, commercial office, institutional, retail and residential uses.

Within the District there has been a series of economic cycles that have markedly changed the pattern of land use over a period of time. The early Italian community which dominated the District including housing, schools, churches, and supporting neighborhood activities. Urban renewal and freeway development of the 1960's brought about the demise of that neighborhood and its ultimate replacement by manufacturing warehousing, and distribution activities. Planning theory of the 1960's tended to promote the separation of land uses into their own discrete zones.



2005 THIRD WARD NEIGHBORHOOD COMPREHENSIVE PLAN DISTRICTS

The 1980's marked a rediscovery of the vital historic qualities of the District leading to the renaissance of the neighborhood for new residential, service, and retail activities.

Continuation of this trend has the potential to lead to an exciting, vital mixture of uses and activities that build upon the unique qualities of the historic district.

The design principle is meant to encourage activities and patterns of compatible land use that already exist in the historic district, see Historic Third Ward Neighborhood Comprehensive Plan.

It is particularly intended to include the unique activities of the fruit and vegetable markets of Commission Row, the continued expansion of residential, service, and retail activities; the expansion of cultural opportunities, galleries, and the theatre; and the continued presence of light manufacturing.

THE PRINCIPLES OF URBAN DESIGN

street enclosure



Historic Pattern of Street Enclosure

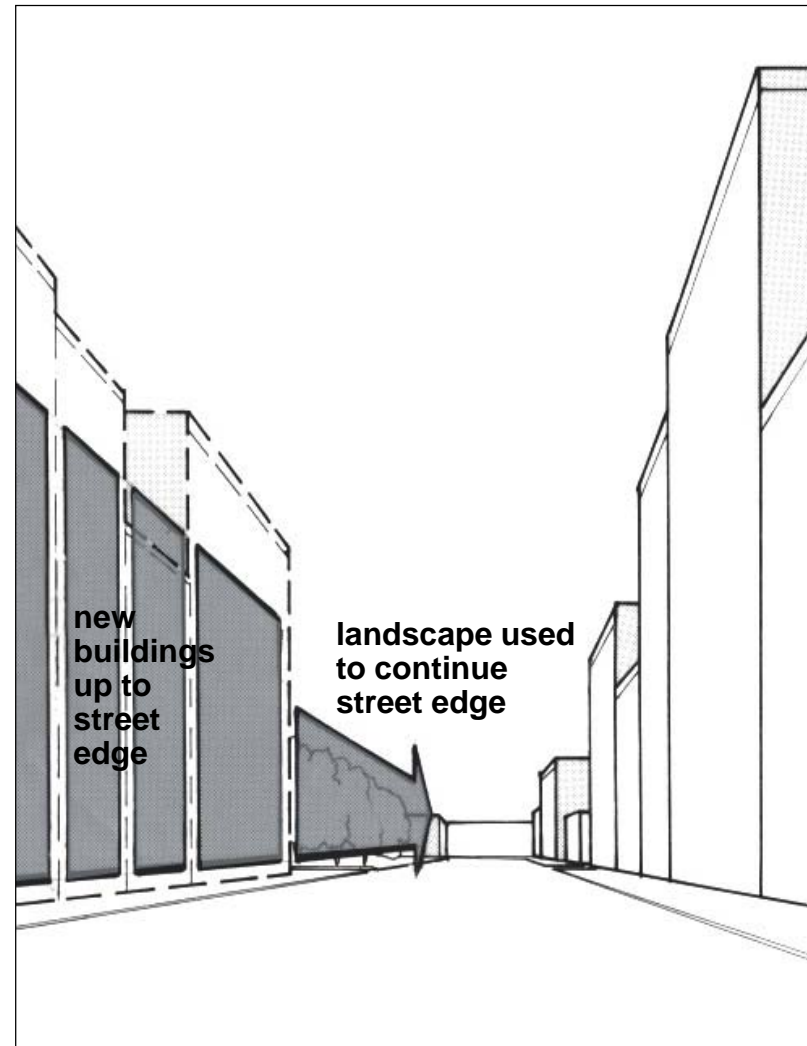

Desirable Development of the Street Edge

Design Guideline: New buildings or additions developed in the neighborhood shall be built up to the street edge to contribute to street enclosure.

Design Principle: The prime underlying principle of all urban places is the enclosure of space by buildings. If space is not satisfactorily enclosed an attractive urban place cannot be achieved.

Historically, buildings in the District were built at the street edge to define the space of the street, reinforcing the urban quality of the district. The 1960's brought about a tendency to locate buildings in the middle of a site with a substantial setback from the street and with open space surrounding the building. This space often became the place for surface car parking.

In places where existing buildings are setback and do not reinforce the street edge, trees and additional landscaping located on the boundary of the property can be used as a temporary expedient.

Exceptions: Residential building types if consistent with the guideline "Residential Street Entrance Transitions" on page 22-23.

continuity of building edge



New Building Provides Street Edge Continuity

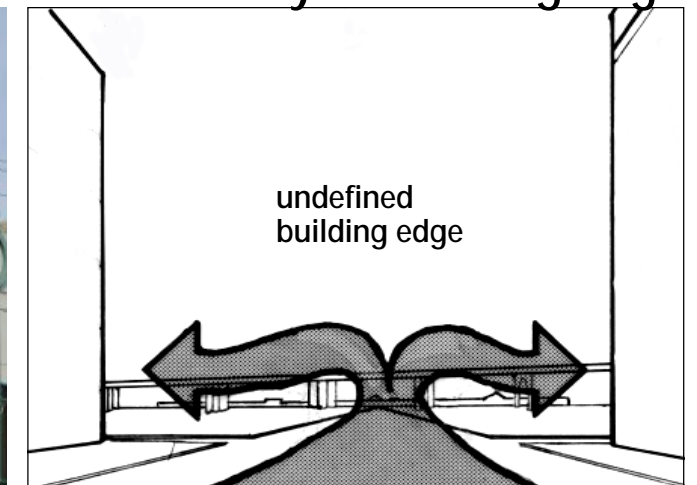

Existing Undefined City Blocks

Preferred Definition of City Blocks

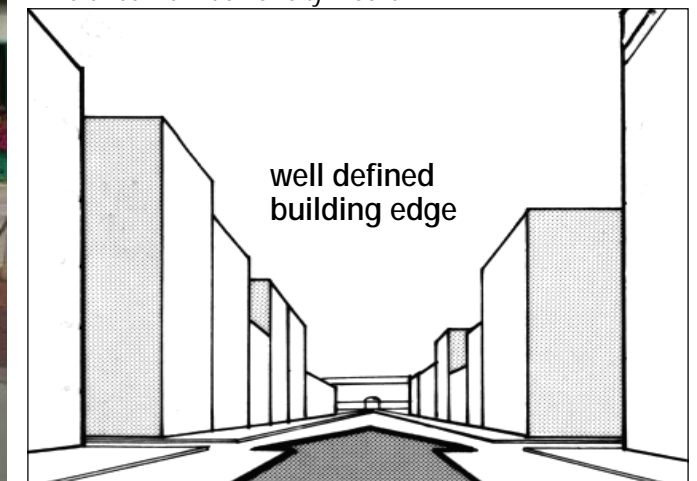

Design Guideline: New buildings should establish a continuous edge at the property line.

Design Principle: Historically, Third Ward street spaces are formed by building fronts at the street edge property line.

In the same way that each building was built up to the street edge property line, each city block was filled with a series of buildings that formed a continuous edge along the street.

Exceptions: Residential building types if consistent with the guideline "Residential Street Entrance Transitions" on page 20-21.

THE PRINCIPLES OF URBAN DESIGN

cross sections of streets



Corners at Streets of Different Widths



New Town Street

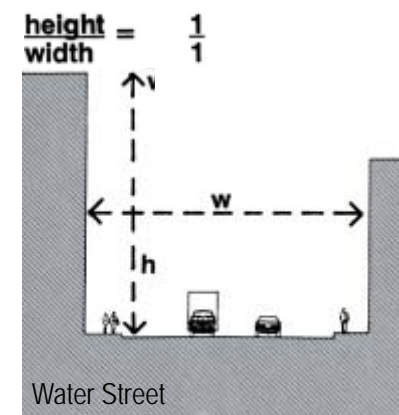
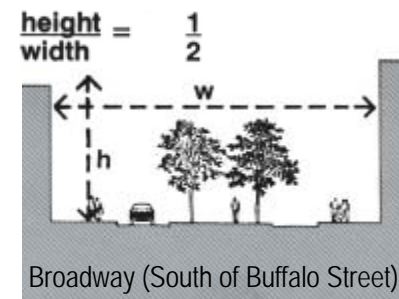
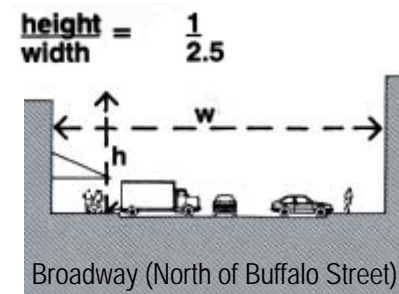

Design Guideline: The overall maximum height of a building, not including unoccupied elements, shall not exceed the width of the street right of way.

Design Principle: Maintain and extend the existing spatial characteristics of the Historic District streets by encouraging multi-story buildings along the street edge throughout the neighborhood.

The current New Urbanist movement promotes this traditional urban street forming approach in idealized new town developments. The relationship between the height of the buildings and the width of the street is important when creating or maintaining the quality of urban streets. If the buildings are too high in relation to the width of the street, a canyon-like effect can be created; if too low, there is no sense of street enclosure.

Design Guideline: The height of street facades along the property line shall not be greater than seven stories and not less than 30'.

The actual height/width ratio that will give a harmonious effect for streets in the Historic District could be as much as 1:1 (the height of the buildings equal to the width of the street). The height/width ratio should be not less than 1:2.5 if a sense of enclosure is to be achieved. Built streets in the Neighborhood fall within this range.

Exceptions: See pages 37 and 53.

cross sections of streets



Inappropriate Canyon Effect



Water Street



Broadway Street

Corner Sites:
For sites on intersecting rights of way of different widths the larger width may be applied in regulating the height within 80 feet of the corner of the street intersection.
Exception: See page 37, Landmark Sites

Clarification:
The front plane of projecting balconies shall not be considered as a building facade.

social life of the street: structure

...Streets should be for staying in, and not just for moving through. Make a bulge in the middle of a public path, and make the path narrower, so that the path forms an enclosure which is a place to stay, not just a place to pass through.*

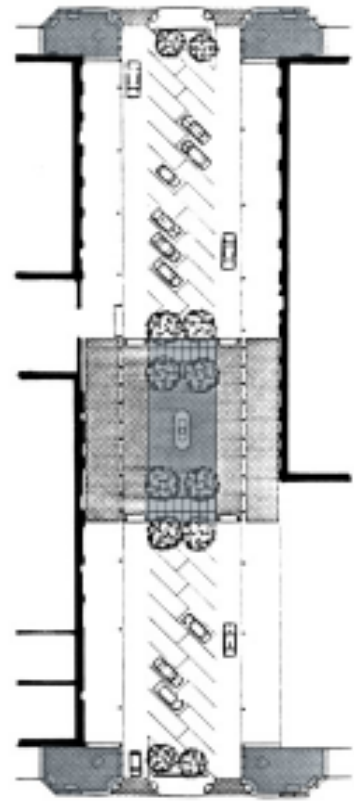

Path Shape

Surround public...places with pockets of activity..partly enclosed areas at the edges,...which make it natural for people to pause and get involved.*



Edge Activity

Design Guideline: The edges of public spaces, streets, squares, plazas, walks, etc., should support the comfort of pedestrians both physically and psychologically.

"Street is the river of the city. We come to these places not to escape from the city but to partake of it." William Whyte.

Early photographs of the Historic Third Ward indicate an intense and diverse street activity generated by the people and activities of the District (see page 47; Activity surrounding Commission Row).

The vitality of an urban neighborhood depends greatly upon the social structure of the street and its sidewalks. The physical form of the street and its surrounding buildings play an important role by providing a setting for these social activities.

Design Guideline: Encourage a variety and intensity of public street life activity by providing different settings for public use.

The configuration of the building at the street edge—windows that overlook the street, the presence of entrances into buildings, the activities that are in the buildings, particularly those in street level spaces, and the quality of the streetscape itself encourage street life.

This street life, in turn, adds to the sense of security and well-being for those who use the street and the surrounding buildings.

The illustrations on this and the following pages give examples of techniques for encouraging a vibrant of street life.

social life of the street: uses

...Squares; they are the largest, most public rooms that the town has. But when they are too large, they look and feel deserted. Make...much smaller than you would first imagine.*



Small Public Square

Design Guideline: Public squares should be small to feel alive, 45' to 65' wide but no more than 70'. Their length can be greater.

Just as the small mid-block street squares on Broadway provide settings for public outdoor activities, new urban spaces will be needed as the neighborhood expands to the east.

Design Guidelines on pages 33-47 of the "Riverwalk Design Guidelines for the Historic Third Ward" are adopted as applicable to all public space design for courtyards, squares, plazas, and walks in the neighborhood and are advisory but not binding in the design of the public street rights of way.

People need green open places to go to...*



Park Green Space

Design Guideline: Parks should be simple, not over-designed and should look and feel public. The following design criteria shall apply.

- Make the greens at least 150 feet across and at least 60,000 square feet in area.
- The space shall be bordered by a street or at least sidewalks on all sides.
- Provide a clean, grassy meadow upon the natural contours of the land.
- Provide shade trees and public monuments.
- Provide benches in the sun protected from the wind.
- Provide unobstructed visual access throughout.

**Excerpts from: A Pattern Language by Christopher Alexander*

social life of the street: uses

The best streets have about them a quality of transparency at their edges.**



Design Guideline: A commercial building facades should provide a high percentage of transparency at the building street edge.

*"...It is windows and doors that give transparency on commercial streets, they invite you in, they show you what is there and if there is something to sell or buy they entice you."***

But windows are important on all streets. "...A street without windows is blind and frightening. When people can see into spaces from the street their world is enlarged."

***Excerpts from: Great Streets by Allan Jacobs*

Encourage cafes to spring up in each neighborhood. Make them intimate places, with several rooms, open to a busy path, where people can sit with coffee or a drink and watch the world go by.*



Design Guideline: Cafe facades along the street edge should activate the sidewalk with outdoor seating or at least large windows.

*As an informal public place to sit, relax, read the newspaper, enjoy a bite to eat and/or drink, and watch or meet people, street cafes "provide the social glue for the community."**

**Excerpts from: A Pattern Language by Christopher Alexander*

social life of the street: entrances

...Treat the edge of the building as a "thing", a "place", a zone with volume to it, not a line or interface which has no thickness.*

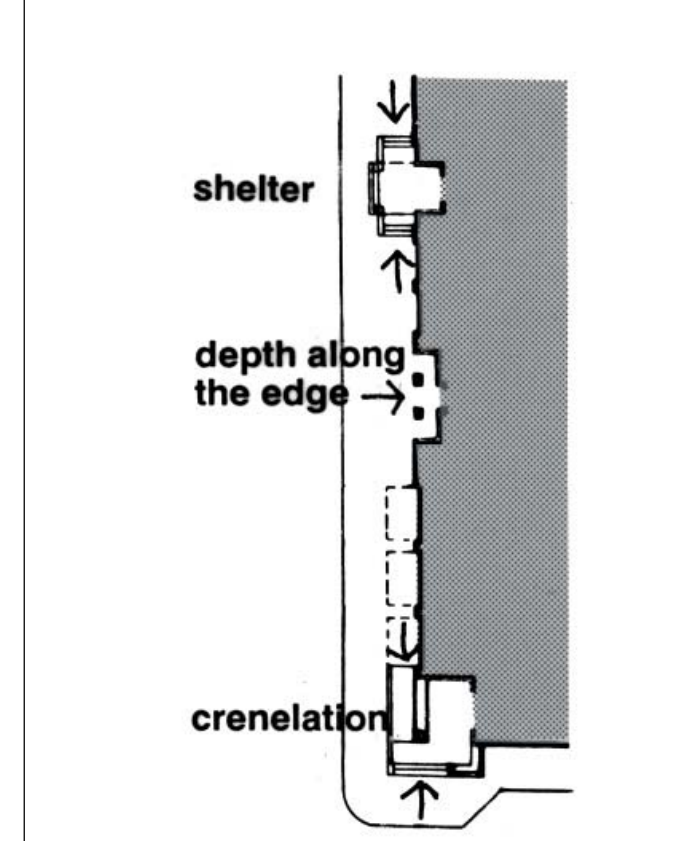

Building Edge

Design Guideline: The edges of buildings along the street should have depth, cover, places to sit, as well as entrances.

Buildings along the street should encourage people to slow down, to linger, and be comfortable doing so. This connects the building to the social life of the street. To accomplish this the edge can offer small places for bench seating, for standing out of the rain, for posting public notices, etc.

**Excerpts from: A Pattern Language by Christopher Alexander*

The best streets are replete with entryways as little as twelve feet apart.**



Design Guideline: Entrances along street facades should be at intervals no greater than 30 feet and exhibit ornamentation consistent with the building's architecture.

*"Doorways...take you in, if only psychologically."** They emphasize the presence of inhabitants, often exhibiting a personal touch. These access points are a natural place for expression, for ornament as various materials meet at corners and edges. Also see pages 70-72.*

***Excerpts from: Great Streets by Allan Jacobs*

Exceptions:

For large tenants where frequent entries are impractical, large display windows may be an acceptable substitute. Ornamented wall surfaces will also be considered.

PRINCIPLES OF URBAN DESIGN

social life of the street: residential entrance transitions

...Make a transition space between the street and the front door. Bring the path which connects the street and entrance through this transition space, and mark it with a change of light, a change of sound, a change of direction, a change of surface, a change of level, perhaps by gateways which make a change of enclosure, and above all, with a change of view...

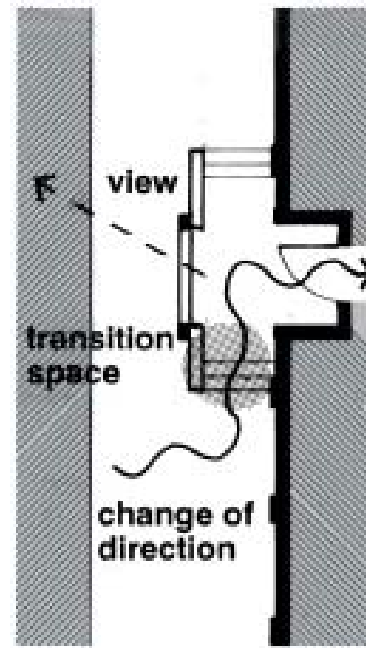

Entrance Transitions

Guideline: As an exception to the Guideline for building up to the street property line, (page 12 and 13), exclusively residential building types should provide entrance transition spaces at the street line, allowing facades to be set back up to 8'.

Semi-public / semi-private terraces, gardens, stairs, courts, etc. raised, (less than 4') a bit above the sidewalk elevation and integrated as a part of the project's design are encouraged forms of residential entry transitions.

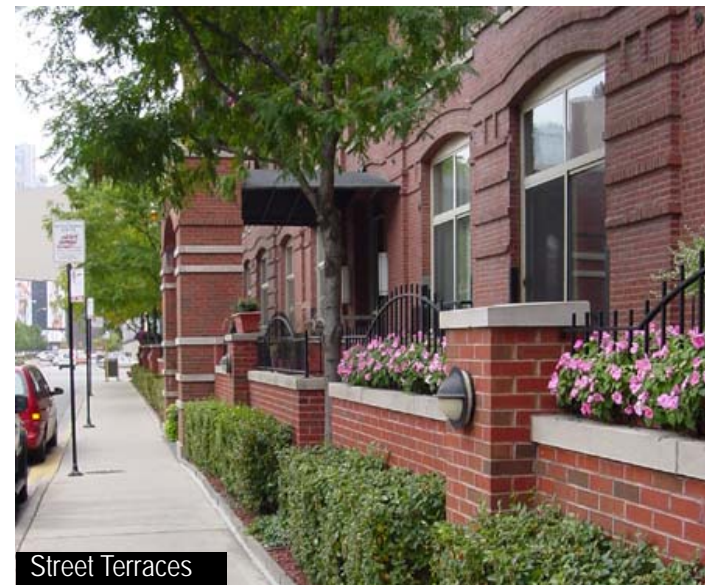

Street Terraces

After a lengthy period of absence residential building types are reappearing in the Third Ward. New multistory mixed use mid-rise types have been constructed following a pattern established by adaptive reuse of industrial warehouses lofts with ground floor commercial. Now, exclusively residential types are beginning to appear. Traditionally the first floor of successful urban residential buildings provide transition from public street to the private dwelling.



Sunken Courts



Entry Stoops



Staircases



Entry Gardens

These urban residential types stress multiple entrances, (as many as possible), and engage semi-public transition spaces that at once enrich and activate the street yet insure the desired privacy required for urban living. The patterns pictured also provide for informal surveillance of the street and therefore contribute to making streets safe places.

THE PRINCIPLES OF URBAN DESIGN

on-street parking



Curbside Diagonal



Street Center Diagonal



Park edge Diagonal



Curbside Parallel

Design Guideline: Street parking should be optimized simultaneously with pedestrian crossings and streetscape improvements.

Design Guideline: While parallel parking is typical along streets, diagonal or perpendicular parking should be used where street width allows an increase in street parking capacity.

Parking is of course a key consideration for any urban redevelopment area. It should not, however, be allowed to adversely impact the qualities necessary for producing great streets as spelled out in this document. There are numerous ways to provide for parking both on (in the public right of way), and off of the street, (private parcel parking and public structures).

Design Guideline: Provide parking along the edge of public squares and parks to help shield the public space from vehicular traffic.

Design Guideline: Parking in the middle of the public right of way should be considered as an alternative that maximizes curb access and pedestrian crossing options.

By applying the strategies in combination the parking impact can be dispersed and more easily integrated to minimize the adverse impacts to the pedestrian environment on the street.

off-street parking



Unacceptable Lot Edge

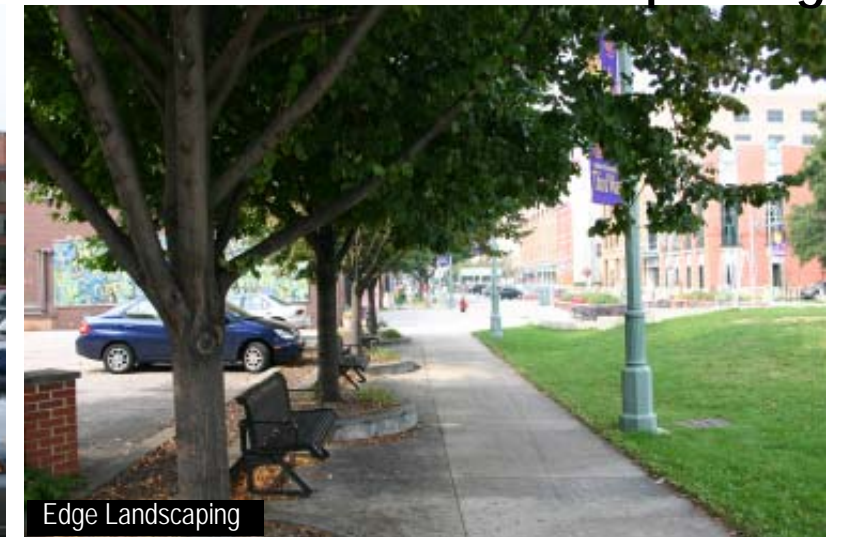

Edge Landscaping



Parking Court



Alley Garages

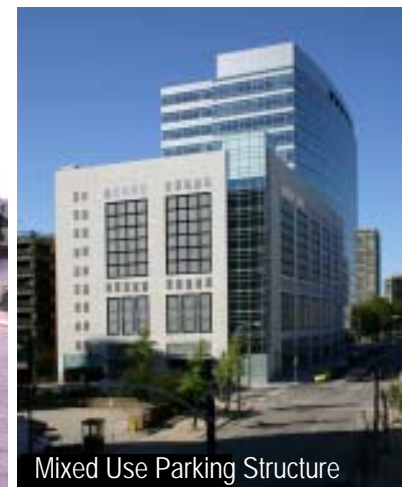

Mixed Use Parking Structure

Design Guideline: Off-street surface parking at the street property line is prohibited.

Design Guideline: Off-street parking access should be from alleys or secondary streets to minimize curb cuts, (limited to two per blockface total).

Design Guideline: Parking behind buildings in mid-block parking courts is highly recommended.

Design Guideline: Surface parking shielded from the street by walls, decorative fences, trees, and landscaping is allowed per City of Milwaukee zoning ordinance. Capacity of these lots should be no more than 24 vehicles.

Design Guideline: High volume parking requirements shall be accommodated in multilevel mixed-use structures whose predominant street level use is not parking.

BUILDINGS WITHIN THE URBAN FRAMEWORK

character
design composition
form

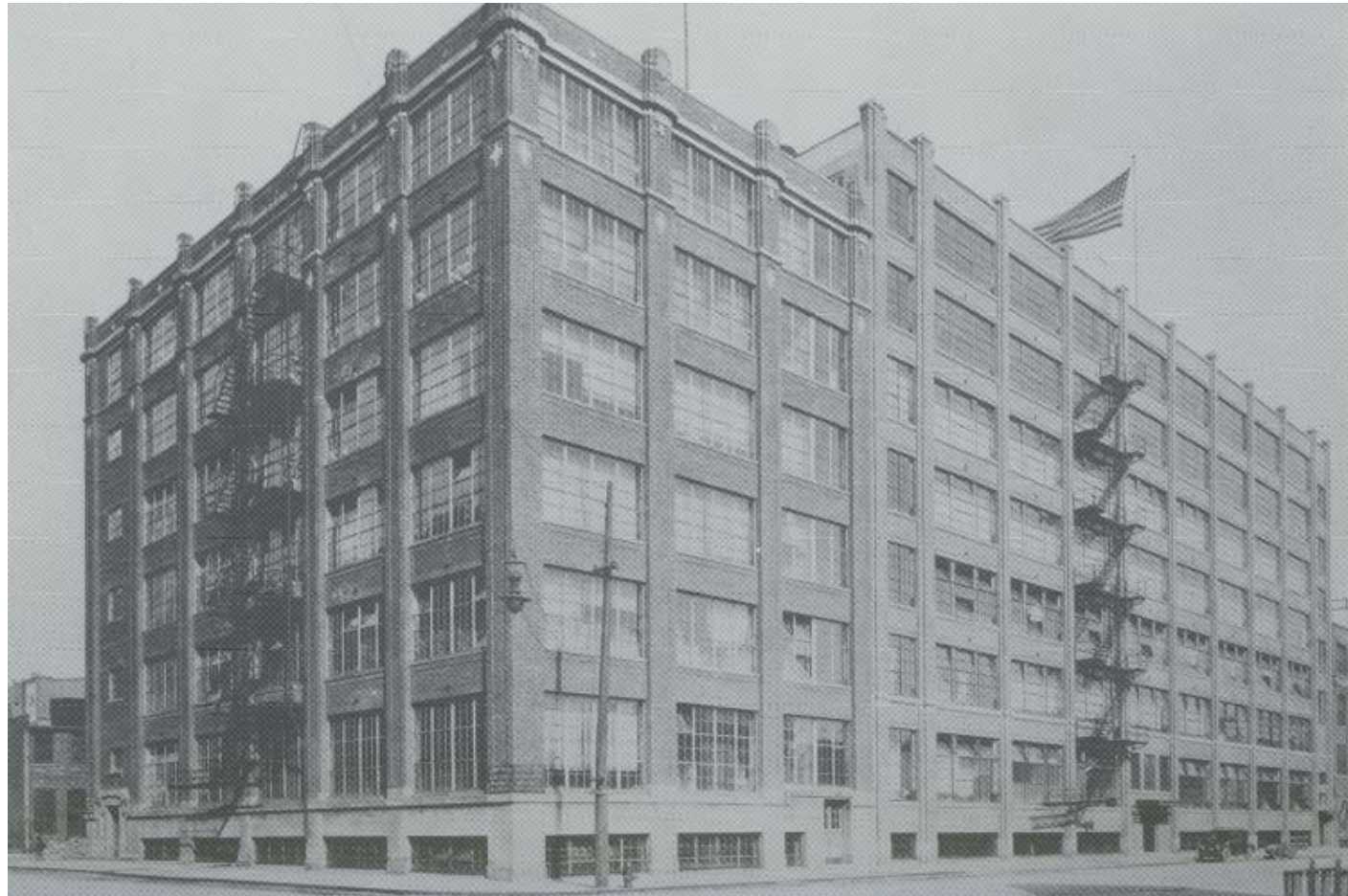

"If a city's streets look interesting, the city looks interesting; If they look dull, the city looks dull." Jane Jacobs: The Death and Life of American Cities. New York, Random House, 1961.

Technical Design Guidelines for the Architect

Introduction

The following design guidelines for buildings are intended to help owners, developers, and architects, for new and existing building alike understand the fundamental building characteristics of this redeveloping mixed use urban neighborhood. The guidelines were derived by systematic and rational analysis of the volumetric nature and external character of a typical Third Ward historic commercial building.

The guidelines are intended to help the architect generate compatible new design work. They are general enough to allow great latitude of individual response yet ensure that new buildings will fit in with the unique ensemble of existing buildings.

Imitating an earlier style or period of architecture is not implied by these guidelines. The architect is encouraged to seek contemporary expression within the general outline presented.

Doing so would be particularly appropriate when the new construction has a completely contemporary function such as a multi-story parking structure, a specialized cultural function, or an institutional program.

In particular, avoid the temptation to “early up” a building, that is, to design a structure in a strictly functional way then “paste on” stock colonial, early American, or other mass produced historical details. The architect should strive instead to integrate the building’s systems and use ornament where systems meet or where it helps to subdivide the facade into the sections suggested in the guidelines.

Ornament can also be used to add richness of detail as described in section three.

Despite the formula like appearance of these guideline, it remains a significant test of design skill to integrate them so as to compose a sensitive contemporary expression within this setting that contributes to the Section 1 emphasis of producing engaging urban streets.

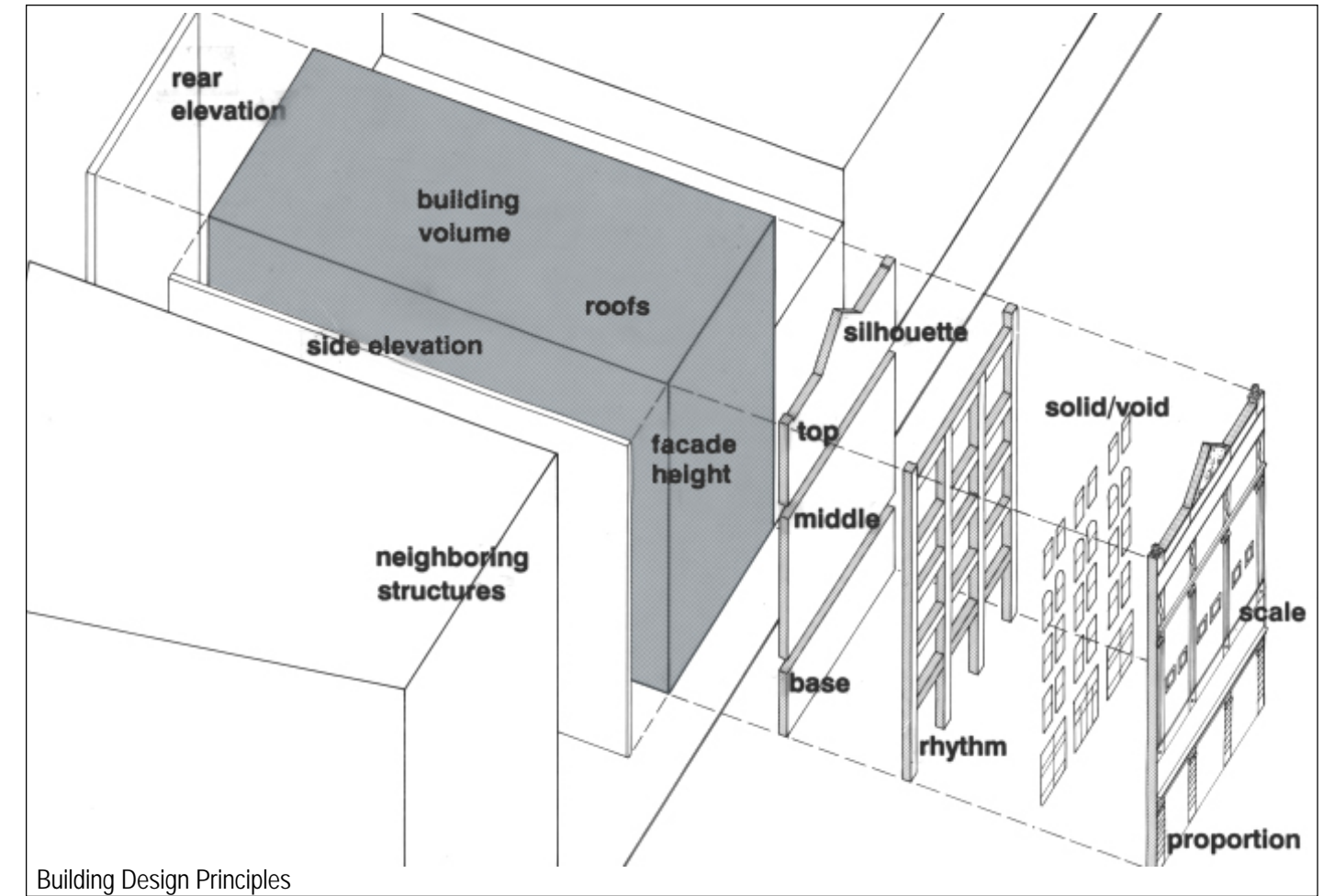



HISTORIC BUILDINGS AND KEY FACADES

Design Guideline: No additional demolition of historic building facades of pivotal or contributing buildings in the historic district will be permitted, see exception.

Design Principle: All effort should be made to keep historic buildings intact.

The street facades for the buildings indicated on the above illustration represent the major historic resource of contributing or pivotal buildings in the listing of the Historic Third Ward in the National Register of Historic Places. It is recommended that every effort be made to adaptively reuse these buildings in a compatible way, requiring minimal alteration.

In cases where the building structure has deteriorated beyond repair, every effort shall be made to salvage the street facades while replacing the remaining portions of the building.

Exception: Removal of buildings with historic facades may be considered by the ARB if the proposal includes replacement with a building of equal or higher design quality consistent with these Design Guidelines

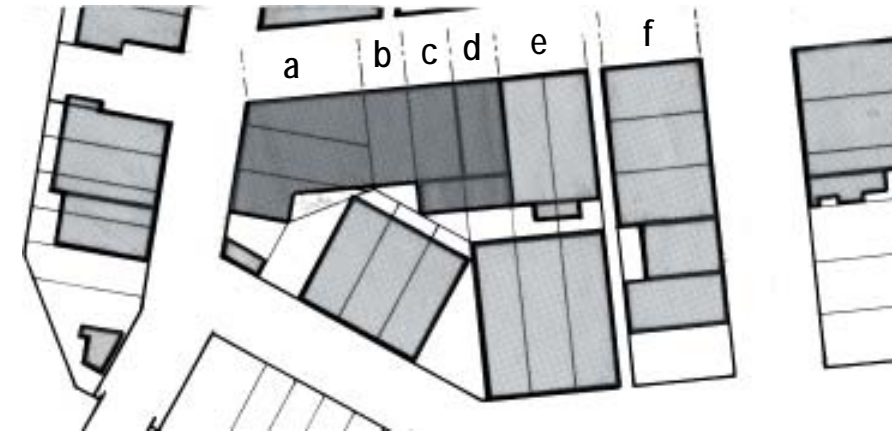

Pattern of Historic Lot Sizes

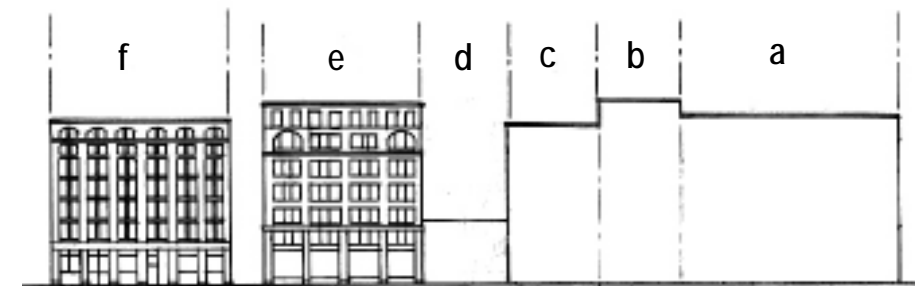

Incorporate Historical Lot Patterns into Building Elevations

Design Guideline: All new building elevations should express a building module similar to the typical historical lot sizes of the Third Ward District.

Design Principle: Traditional lot sizes were a fundamental characteristic of the parceling of the District and therefore became a determining factor in the footprint and massing of the original buildings.

New buildings tend to be larger units of construction than the buildings that were built in earlier generations. This change in scale of the building has a profound effect on the scale of the District and on the quality of the street environment.

Proposed new buildings on a site larger than a single lot should express the original lot sizes in their structural modules. To achieve this, it may be appropriate for the structural system of these buildings to relate to the lot sizes and become a determinant of the facade articulation, assuring compatibility with the scale of historic development. Also see page 39.

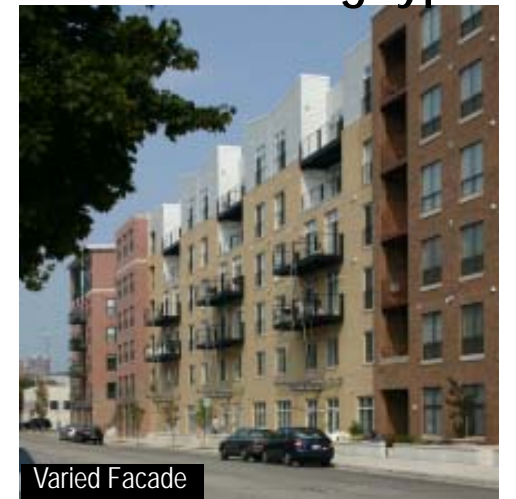

Varied Facade



Multiple Buildings

CHARACTER

variety



Design Guideline: New buildings in the Neighborhood should be designed using similar materials (brick, metal, glass, stone) to those used on existing buildings and respect the mass, rhythm, height, robust scale, and ornamentation of existing buildings.

There is no predominant architectural style among the buildings of the District. In some cases, styles are mixed within the composition of a single building. There is, however, a more general level of similarity. Most structures are of masonry construction, predominately brick. Their height was controlled by fire codes, and their mass by lot sizes. Construction methods controlled the structural rhythm and structural pattern of floors, walls, and columns. Openings appear as if punched into the masonry facade. The application of ornament to this basic Early 20th Century warehouse type provides variety and richness.

There are some structures that avoid the historical revivalist styles (for example, Artcraft Building, Terminal Building, or 240 North Milwaukee Street). Whether Art Deco or Art Moderne, they express the modern idioms of longer spans, concrete frame, and the larger curtain wall or industrial sash type of window. This style rejects ornamental moldings, classical elements, etc., choosing instead to emphasize simplicity of form and line. These buildings should be recognized and treated as products of the more recent modernist era.

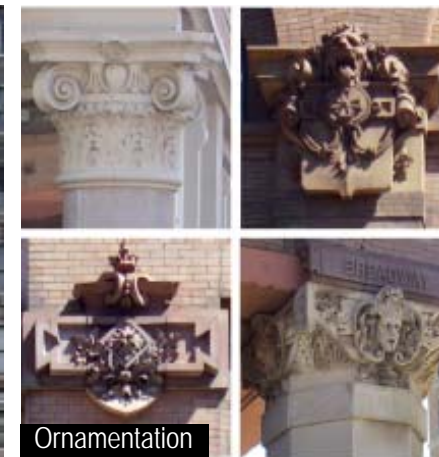

Proposed new buildings should respect the prevalent characteristics elaborated within these guidelines without mimicking any particular building. Following the guidelines contained within this publication should lead to new buildings that fit comfortably into the context of the urban streets of the District and yet express their own individuality and time.

CHARACTER

design themes - adaptive reuse



Third Ward Lofts/ Retail



Third Ward Office/ Pub



Third Ward Office/ Lofts



Georgetown Office/ Retail

Design Guideline: Architects should creatively reinterpret the industrial strength character of the Third Ward in generating contemporary architectural proposals for the neighborhood.

Design Principle: The Historic Third Ward's architecture expresses an original economic landscape of industry and commerce.

The existing *Design Guidelines for the Historic Third Ward District* were developed by a process that carefully analyzed the character of the historic core. This ensemble of turn of the century industrial warehouse buildings give the Third Ward its distinction as a city district. Its image clearly differs from the East Side, Riverwest, Downtown, etc., because of its economic history. These buildings supported a work environment with flexible high open bay structural systems of heavy timber or board-formed concrete. Adaptability is the nature of these spaces so when the industrial uses left, other commercial, then residential, uses were attracted to these spacious and robust New York style industrial loft environments.

CHARACTER

design themes - industrial aesthetic



Milwaukee Public Market



San Diego Housing



Chicago Housing



Third Ward Parking

Pages 30-31 of the *Design Guidelines* explain that the envelopes that wrapped around these industrial strength structures were either thick masonry bearing walls with large punched openings or expressed structural frames with full bay infill window walls. The former allowed for traditional revivalist styling with applied stone and terra cotta ornamentation, while the latter reflects a modern functionalism. While no architectural style dominates, what is consistent is this robust character of materials and construction systems combined with an industrial scale of components, windows, and details. The environment is at once richly diverse yet authentically industrial.

Clearly, the strength of image in the Third Ward derives from its industrial workplace aesthetic. New buildings are encouraged to emulate these unique qualities.

CHARACTER

design themes - urban residential



Milwaukee- Traditional



European Minimalism



Philadelphia Townhouses- Modern



San Diego Townhouses- Contemporary

Design Guideline: Residential building types shall enrich the street with individual street entrances for each ground/first level unit.

Design Principle: Well designed residential building types establish the fabric of the city and transform city streets into sustainable neighborhoods.

Cities chronicle architectural movements which adds to their richness and diversity over time. The Third Ward's revivalist, modern functionalist, and post modern (1980's-90's) facades express this variety.

The progressive image of the Third Ward suggests an aggressive contemporary approach to new architecture. The existing guidelines concurred, requesting that, "...new buildings fit comfortably into the District yet express their individuality and time."

Though new commercial office development may at some point return the extension of the neighborhood beyond the Historic District is presently driven by multiple family housing types and mixed use development. While the housing is often based on double loaded corridor types and townhouses, a variation, the contemporary urban loft, has emerged.

CHARACTER

design themes - urban mixed use



Japan Housing/ Retail

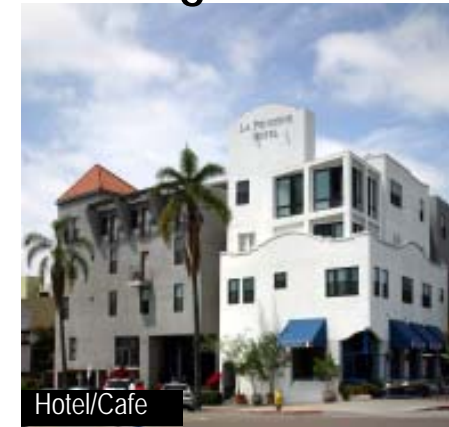

Hotel/Cafe



Madison Housing / Office



Japan Housing/ Retail

Combining the American ideal of owning a new home with the appeal of Historic Industrial Loft living, this loft phenomena may in part be responsible for the renewed interest in urban living. The architectural implications are exciting and the Third Ward is a natural location. This new loft type is being explored internationally by architects from Finland to Australia, from Japan to the Netherlands. The universal intention, contemporary architecture creating activated urban streets, is encouraged in this neighborhood. In order to achieve this, as discussed in the first section of these guidelines, ground floor architectural expression and use are critical. Mixing unit types or mixing in commercial space has proven to be a successful design and development strategy.

Though functional and efficient dwelling units with marketable amenities are critical to successful urban housing, the streets these buildings define must be enriched with semipublic transition spaces to bring the neighborhood to life.

Contemporary architectural expression of urban residential building types integrating outdoor transition spaces is encouraged.

CHARACTER

design themes - low-rise industrial reuse



Third Ward



Transparency Adds Interest



New Window Wall



Layering



New Elements



Mixed Materials

Design Guideline: Existing low-rise manufacturing buildings or low-rise portions of buildings should be aggressively redesigned to add visual interest to the street.

Design Principle: High demolition costs may warrant an adaptive reuse/renovation redevelopment approach.

In the last half of the 20th century, industrial building types shifted strongly to steel structural systems with premanufactured modular components. The Ward has a number of these lowrise buildings to the east of the historic core. They offer little to enhance the pedestrian environment of the street.

Recently, however, a number of west coast architects have produced some remarkably creative adaptive reuse prototypes for this building type. A number of examples are included above. The compelling aspects include dramatic juxtapositions of new architectural/sculptural features within the previously unadorned industrial fabric.

CHARACTER

landmark sites



Weisman Museum-Minneapolis



Luxor Theater-Rotterdam



Twin Church Gateway-Rome



High Rise

Design Guideline: Signature buildings for landmark sites need only comply with the guidelines on pages 8, 17, 19, 23, 38, 46, 49, 51, and 62.

Design Principle: There exists two kinds of buildings in the city: Those that make up the city's urban fabric and landmark, signature buildings.

Some of the requirements within these guidelines may be suspended at the Architectural Review Board's discretion, if the site is identified within the Third Ward Neighborhood Comprehensive Plan as a landmark site suited for a signature building. Signature buildings shall achieve a unique contemporary design of the highest standards.

They will be evaluated by the ARB based upon a point system weighted by each Board member according to these criteria:

Max. Points	Criteria
25	Responsiveness to nine Guidelines above;
25	Design Firm's commitment to design quality, as represented by a National or three State Design Awards in the past 5 years;
25	Quality of Enclosure / Materials Systems;
25	Overall Appeal of Project as a Landmark.

Projects require an ARB average score of 90 or more for approval.

CHARACTER

street facades

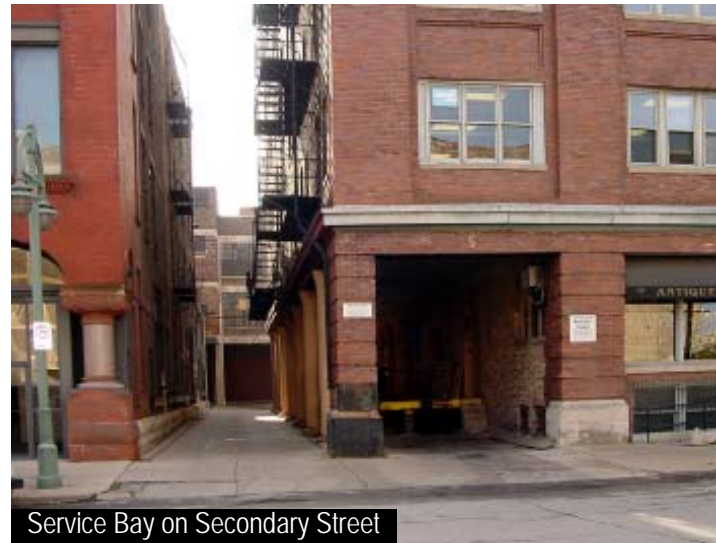

Service Bay on Secondary Street



Main Facade Fronts Major Street



Service Alley



Service Bay on Alley



Service Bay on Alley

Design Guideline: Major facades and entrances should face the major streets, (and river). Access to service bays and to parking should be from secondary streets or alleys.

Design Principle: Buildings in a traditional city pattern have fronts and backs.

Buildings in the Historic Third Ward are organized in a typical grid of streets and blocks with primary streets running north and south, and secondary streets running east and west. Service alleys generally divide the blocks and are entered from the secondary streets.

Building fronts face the street, define the public space of the street, and form the major public entrances.

Building sides and backs, which face minor streets and alleys, respectively, are used primarily for service

Historically, corner buildings at street intersections often responded to both streets by providing corner entrances emphasized by robust decorative columns.

New buildings should acknowledge this characteristic orientation, thereby contributing to the traditional clarity of public street fronts while appropriately placing service access.

diversity



Retains Historic Corner



Facade Diversity



New Diverse Housing Facades



New Housing Lacks Diversity

Design Guideline: Design diversity is required for large (block long) parcels.

Design Principle: "...More buildings along a given length of street contribute more than do fewer buildings."

The Historic District exhibits a pattern of building development over time. The earliest development is represented by multiple buildings along a block face. Later, the block-long facade appeared along the river. The earlier pattern is favored as more interesting, more diverse, "All of the best streets...exhibit many buildings..." In the long term, diverse developments are more sustainable, more resilient and accommodating in the face of change.

Large developments from New York's Battery Park City to Florida's new towns have insured diversity by commissioning multiple design architects engaged for separate buildings.

" Excerpt from Great Streets by Allan B. Jacobs

CHARACTER

riverfront facades

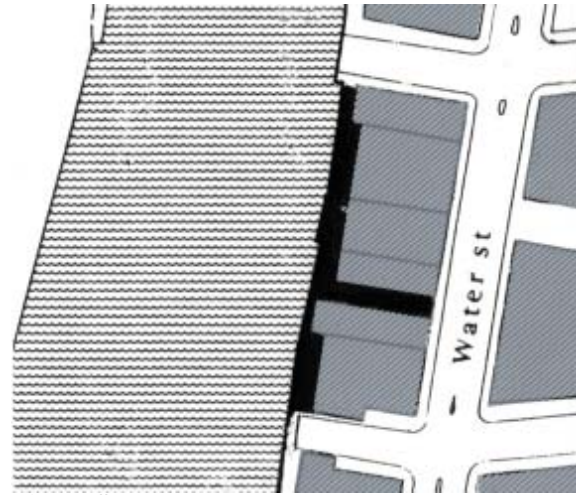

Riverwalk Frontage

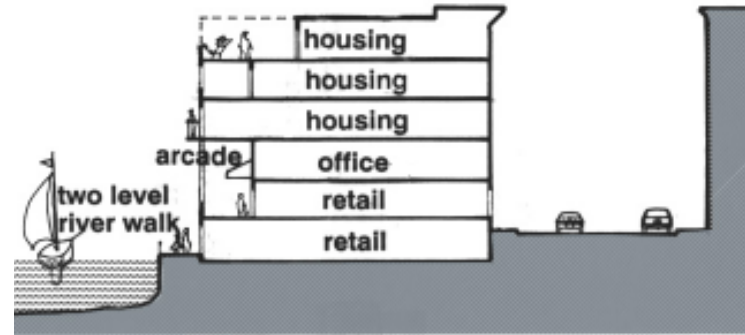

Mixed-Use Prototype Cross-Section



Riverfront Facades



Amsterdam New Loft Housing

Design Guideline: Riverfront facades should follow the design guidelines established for street facades while embracing the design character of the publicly accessible river walks.

The portion of the Historic Third Ward that makes contact with the edge of the Milwaukee River offers a unique opportunity for a dramatically different, water-oriented pedestrian environment. The 1986 Master Plan proposed a two level riverwalk concept with lower level boat and water-oriented activities and upper level economic opportunities for cafes, entertainment, and retail use.

The character of this river edge and of the alterations to the existing adjacent building facades will be more dependent upon the proposed new use, access requirements, the structural condition of existing buildings, and the need for natural light penetration than the traditional back facade character these buildings currently display. The new riverfront facades should take care to avoid the sterility often resulting from major new construction. It is recommended that new proposals retain as much of the existing building as is possible.



Amsterdam New Loft Housing

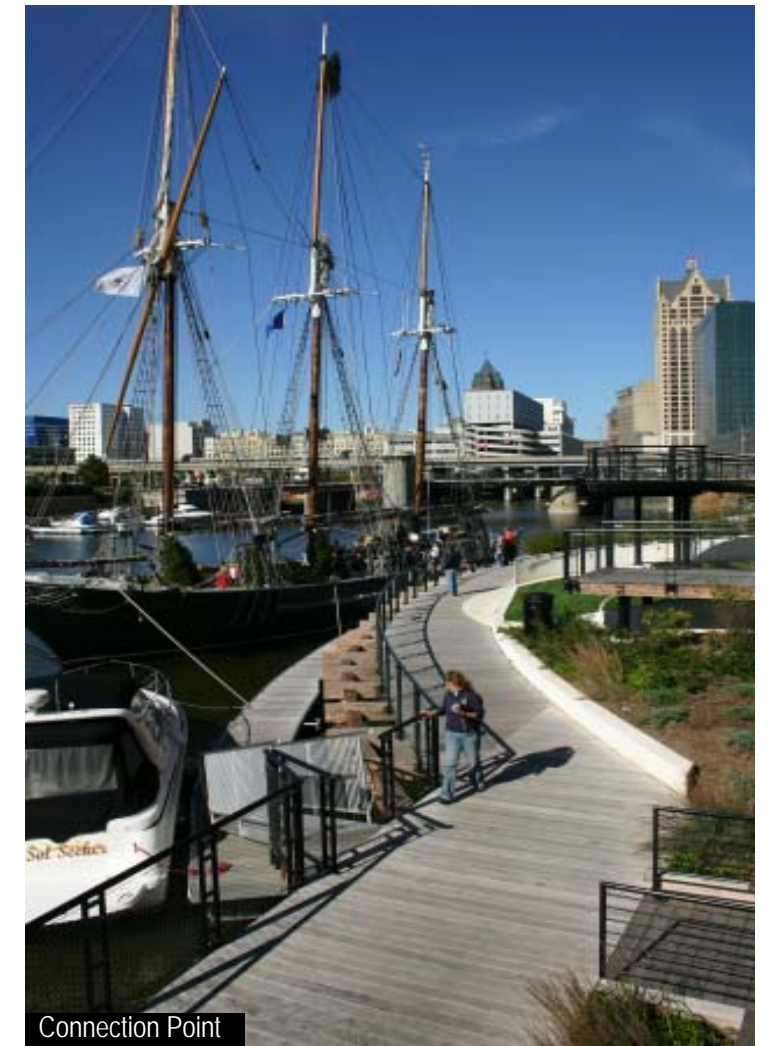

Connection Point

Design Guideline: Adjacent private property developing a connection to the Riverwalk should reflect use of materials and details that are found on the Historic Third Ward Riverwalk.

The development of the riverfront also presents opportunities for new construction. The new development should respect the character and spirit of the Historic Third Ward development pattern and buildings for both existing buildings and new. Therefore, all the river facades are subject to the guidelines in this publication.

In addition, physical and aesthetic continuity of the Historic Third Ward riverwalk is advised.

For Riverwalk details, see the Appendix to this document.

DESIGN COMPOSITION

base, middle, top

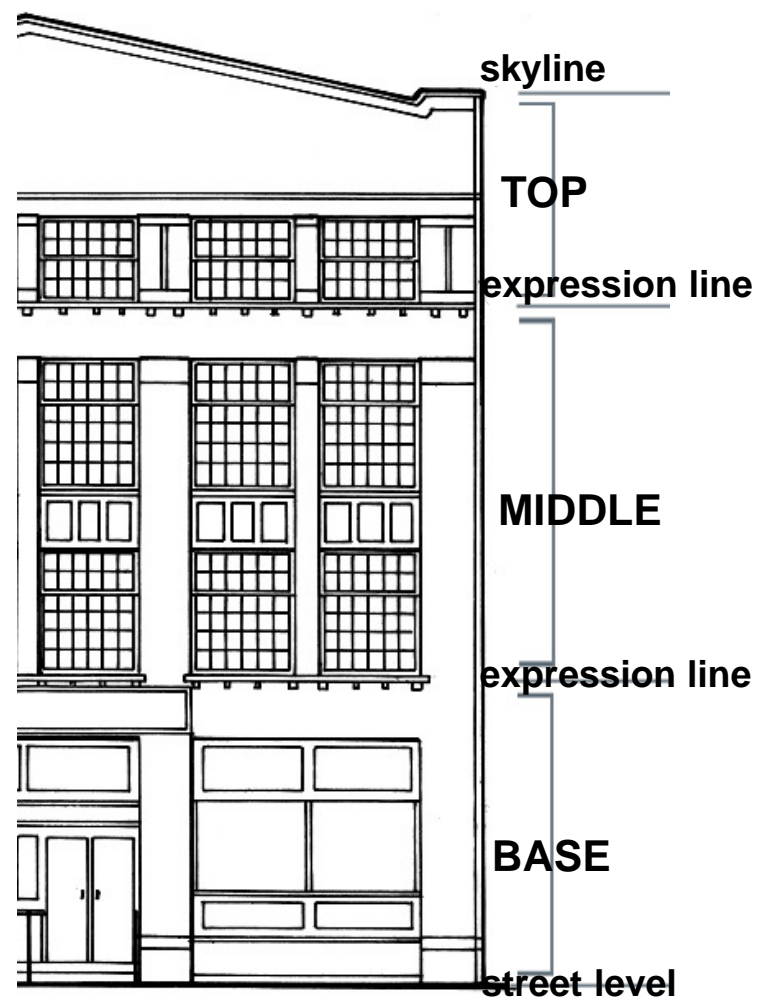

Historic District Example

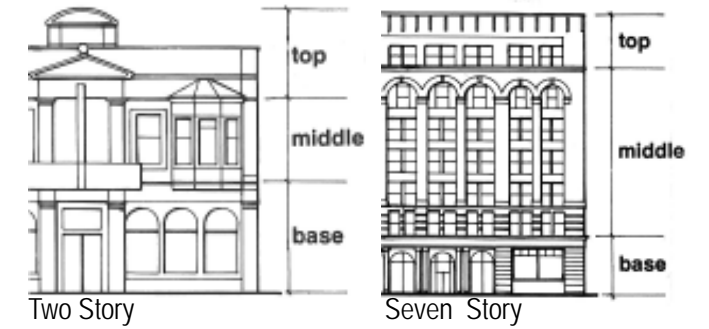

Design Guideline: The architectural composition of building elevations shall express base, middle, and top articulation on all street facades.

Design Principle: Emulating the human body, one of the tenets of architectural composition is the idea of a building having a base, middle, and a top. This has been borne out in the history of architecture for thousands of years.

Buildings in the District clearly display this characteristic. The top of the building terminates the building against the sky; the middle abstractly communicates the building's function or use; and the base firmly anchors the building to the ground at the same time presenting a close range interface with people. It is especially important in the Historic District that new buildings adhere to this tripartite composition.

The transition between the base and the middle or between the middle and the top are often articulated by the use of contrasting materials or ornamental projecting elements. These horizontal bands on buildings form expression lines that give scale and character to a facade. They become important clues for similar expression lines on adjacent new buildings.

DESIGN COMPOSITION

roofs

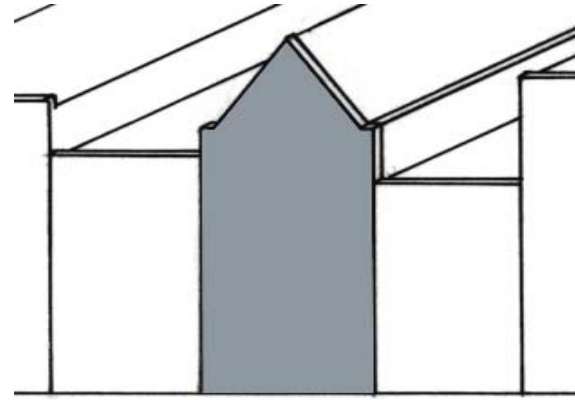

Inappropriate Gabled Roof Form

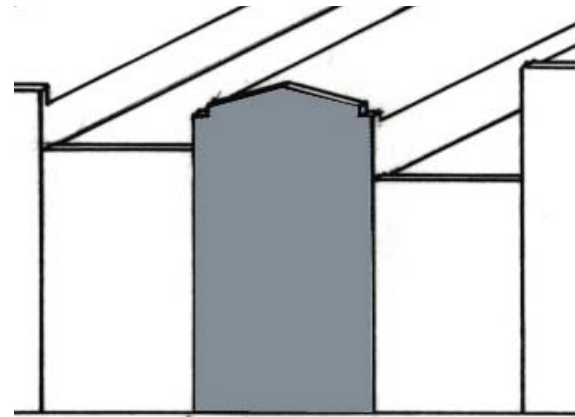

Appropriate Decorated Parapet Wall

Design Guideline: Gabled roof forms shall not be expressed on the street facade.

Design Principle: The Third Ward differs from other neighborhoods by virtue of its buildings having almost exclusively parapet construction with flat roofs.

Flat, sloping roofed buildings predominate in the Historic Third Ward. The commercial or industrial structures were generally wider than residential buildings. They spanned this greater distance with internal column and beam structural systems which created flat roofs with a slight slope to the rear of the building.

Few wood-framed pitched or gabled roof buildings survived the late nineteenth century fires. The disasters also destroyed many of the residential properties which had pitched roofs. The present character of the District is a setting where the expression of pitched roofs with ridge lines on the street facade is out of character. Such roofs should be avoided.

silhouette



Examples of Ornamented Skyline



Pattern of Existing Parapets

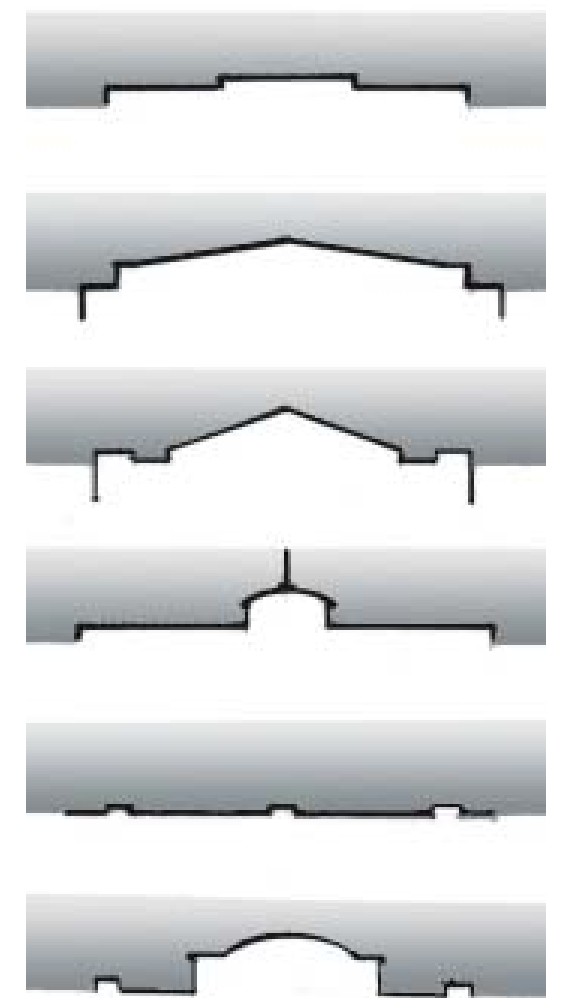

Design Guideline: The top of the street facade should be articulated to provide a unique silhouette to the building when seen from the street level.

Design Principle: A building's top expression can be relatively easily achieved by unique parapet articulation, thus adding design diversity along the street.

The adjacent drawings were all prepared from photographs of existing buildings in the Third Ward. The pattern of parapets on the street facade was one of two concepts for completing the building's top. The projecting cornice was the other. The architects or builders of these structures found an opportunity for expressing individuality by varying these features.

Where projecting cornices create an element which terminates the building wall, the articulated parapet seeks to caress and interlock with the sky.

New buildings should interpret one of these conditions for completing the facade of the building.

DESIGN COMPOSITION

proportion

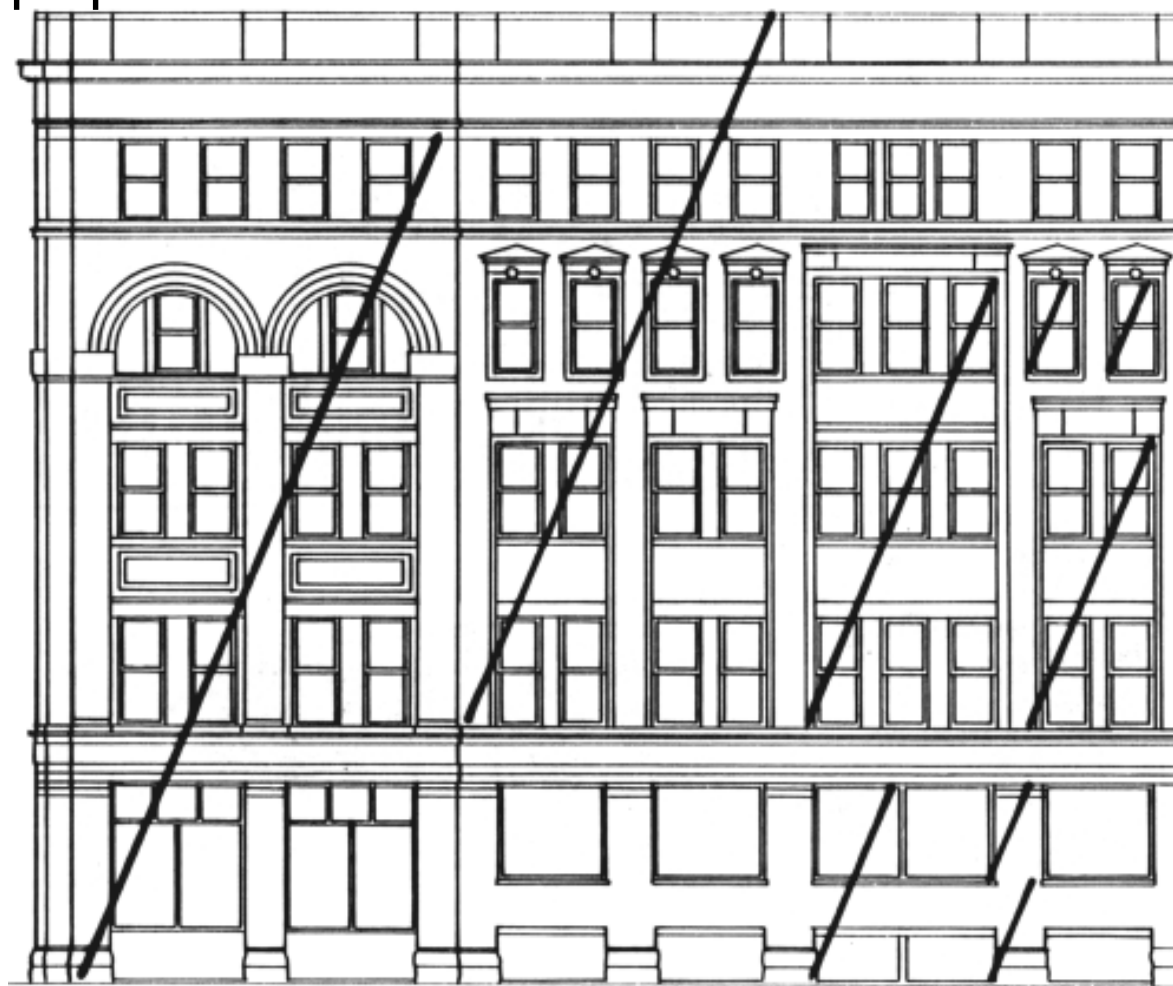

Consistent Proportions on Existing Facade

Design Guideline: Each structural bay of the street facade should have a vertical proportion (the height of the grid is greater than the width of the grid).

Design Principle: Proportion is the numeric ratio of two opposing dimensions of a form or space such as height to width, width to depth, etc. The intent of all theories of proportion is to create a sense of order among elements of a building.

For example, in designing a building facade, a proportioning system can be established that is based on a characteristic ratio that is reflected in the individual elements, the spaces between elements, and groupings of the elements. The same proportion may also be evident in the overall ratios of the whole facade, thus a harmony of parts to the whole.

Within the Historic Third Ward such underlying ratios are evident. The structural columns that dominate most facades establish a building bay module with a greater height than width that creates a vertical proportion. This same ratio is then transferred to other facade elements (windows, for example to further emphasize the overall vertical pattern).

The diagonal lines on the drawing above are virtually parallel indicating the similarity of proportion between the several parts of the building. These regulating lines can be used to verify the relationships between facade elements.

rhythm

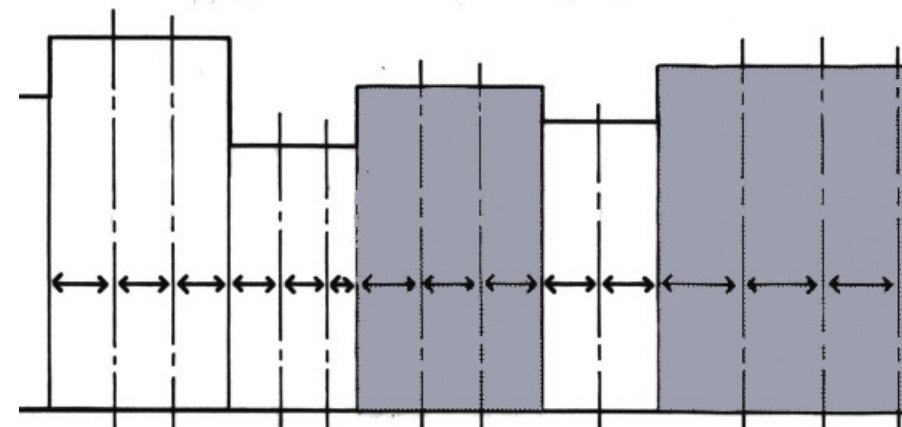

Expressed Structural Rhythm 15'-25'



Varied Bay Widths

Design Principle: New buildings should express a structural rhythm on the street facade consistent with that of the existing historic buildings.

Design Principle: In architectural composition, rhythm refers to the regular or harmonious recurrence of building elements.

With respect to Third Ward facades, the most obvious recurring facade elements are structural bays demarcated by robust masonry columns. The patterns of repetition utilized varies from building to building resulting in a variety of visual rhythms. The simplest is an even spacing of repetitive columns, but often the end bays were given special identity by varying their width to be either wider or narrower than typical bays.

Sometimes structural rhythm relates to special functional restraints of the buildings use. This causes more complex syncopated rhythms. The variation of rhythm from building to building reaffirms the individuality of each building while the reoccurrence of the robust structural piers helps unify the District as a family of similar structures.

DESIGN COMPOSITION

solid and void



Elevation Showing Relationship of Window to Wall

Design Guideline: The majority of the surface of the base of the building on the street facade should be transparent (see page 20). Inversely, the majority (over 50%) of the surface area above the base should be appear solid or translucent, (also see page 18).

Design Principle: Flat, unadorned repetitive curtainwall facades lack visual interest and contribute little to the visual interest of the street wall.

A large percentage of the Historic Third Ward's major street facades are constructed of brick with the upper floors supported on a structural element located above the first floor windows. This has resulted in large glass areas for the ground level storefronts and smaller, so called punched openings in the brick of the upper floor for general fenestration.

The resultant solid to void relationship is characterized by the lower floor having a majority of its surface as void or window, and the upper floors having a majority of their surface as solid or brick.

New construction should respect this historic solid to void surface configuration, generally providing retail use at the street level with commercial or more private, residential uses on the upper floors.

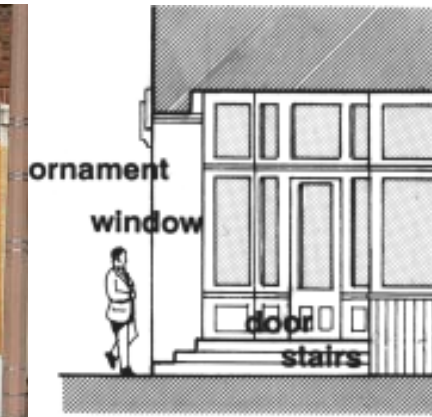

Scale Elements at Entry

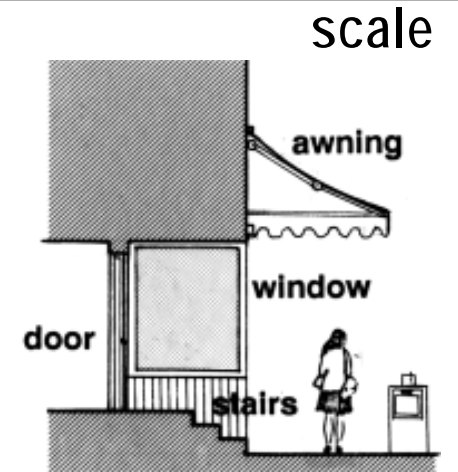

scale

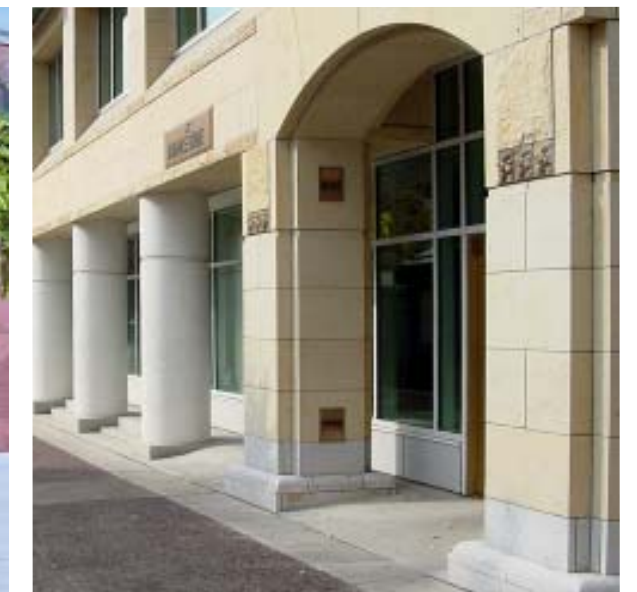

Design Guideline: The base of the building should include elements that relate to the human scale. These should include doors and windows, projections, columns, awnings and canopies, ornament, etc.

Design Principle: Elements that mediate between the overall size of a building and the size of a person, give it human scale.

Human scale in architecture is based on the human body. It is very common to rely on visual clues to get a sense of how big a building or space is by relating the overall dimension to some known dimension. Such elements as steps, doors, door hardware, etc., help people judge the size of a building.

This recognition of human scale permeates the Third Ward's older buildings so that people feel comfortable in close proximity to them. It is desirable to retain and enhance this characteristic and to incorporate the lessons from the buildings of an earlier era into new design.

To achieve this, it is important to articulate building entrances and other parts of the base of the buildings with elements that people can relate to.

DESIGN COMPOSITION

neighboring structures - height

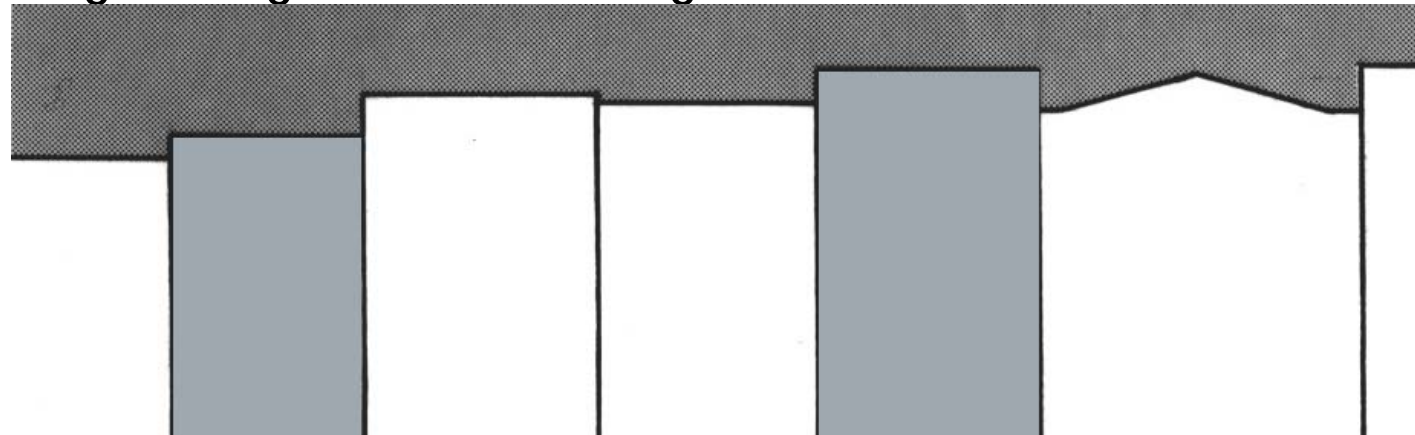

Diversity in Building Height



Chicago Street



Water Street

Design Guideline: New buildings should not be equal in height to adjacent buildings.

Design Principle: Consistent with the historical context, height variance from building to building supports individual design expression and diversity (see page 39).

For a variety of reasons, buildings in the Historic Third Ward are of different heights. This characteristic could be attributed to a desire for individual expression, to avoid construction complications in joining two adjoining buildings, or as a natural result of slight difference in floor-to-floor heights.

This skyline characteristic was also the result of individual buildings of a basically vertical nature having been built side by side over time.

To further reinforce this characteristic new buildings should not be built at the same height as their neighbors. This design objective not only strives to maintain the skyline character of the District but also to offer new building projects the opportunity for individual expression.

neighboring structures - expression lines



Expression Lines Carried Over

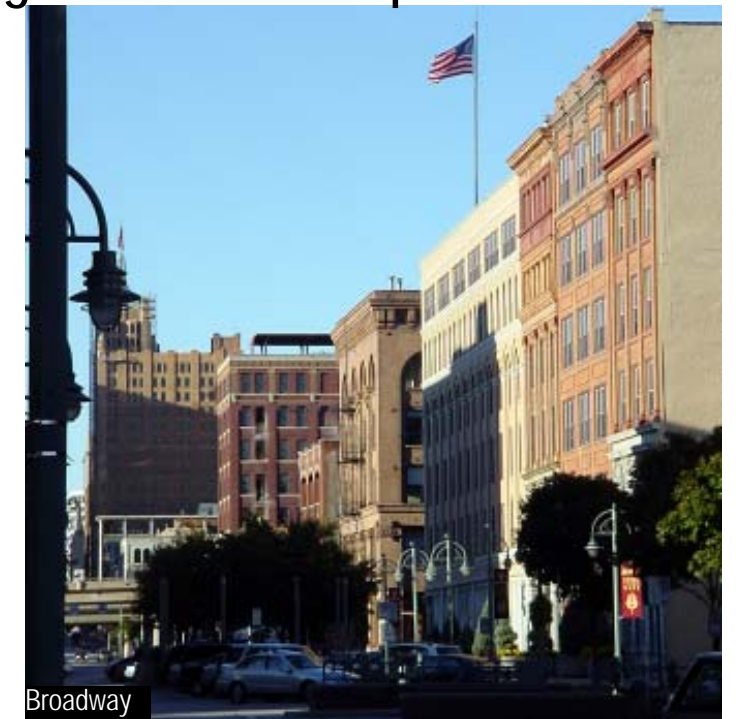

Broadway



Expression Lines Derived from Adjacent Buildings

Design Guideline: Expression lines derived from adjacent structures shall be integrated into the design of new street facades.

Design Principle: While diversity is desirable, respect for common traits and expression lines creates order and unifies the street blockface.

Floor-to-floor heights and overall building heights of structure in the District are invariably different due to the variety of original uses of the buildings.

However, as a result of the traditional attention paid to concepts such as base, middle, and top, there exists strong horizontal expression or architectural control lines throughout the District. These lines should be respected for all new construction.

Careful analysis of adjacent facades will provide numerous horizontal generating lines which, when carried over to new construction, will ensure continuity of character, and a compatibility that connects the 'new' to the District's historic facades.

It is not the intent of this principle that expression lines from one building to the next align exactly. It is desirable however, that the spirit of adjacent facades be adapted for new infill proposals.

FORM

infill sites

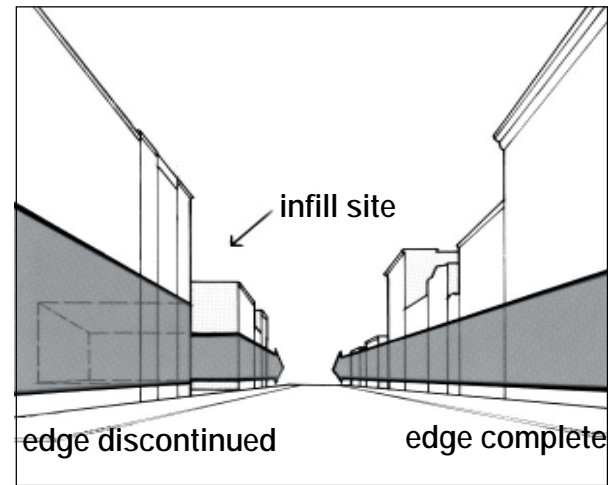

Existing Vacant Sites
Undesirable Development

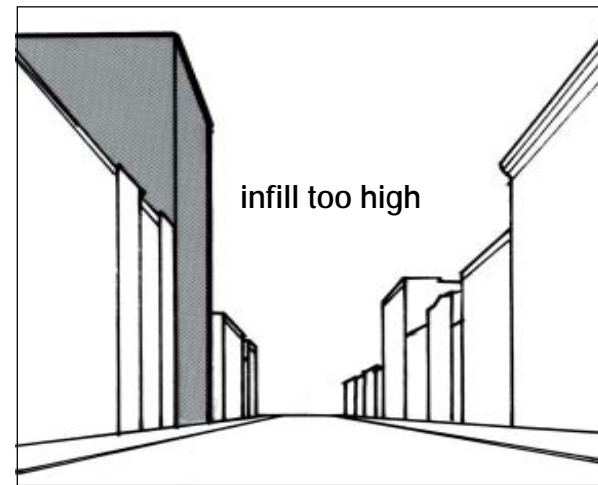

Undesirable Development
Desirable Infill of Vacant Site

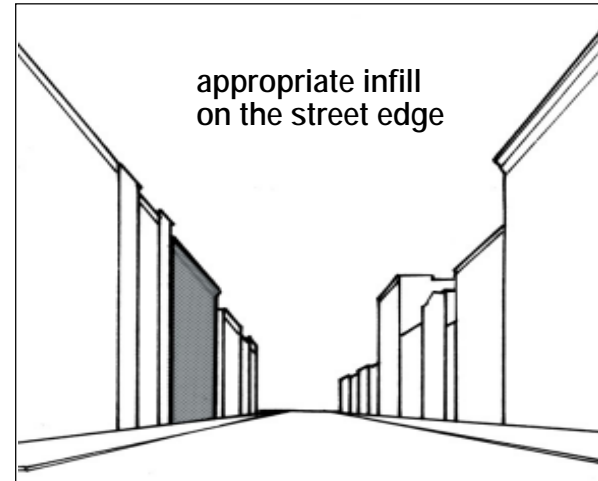
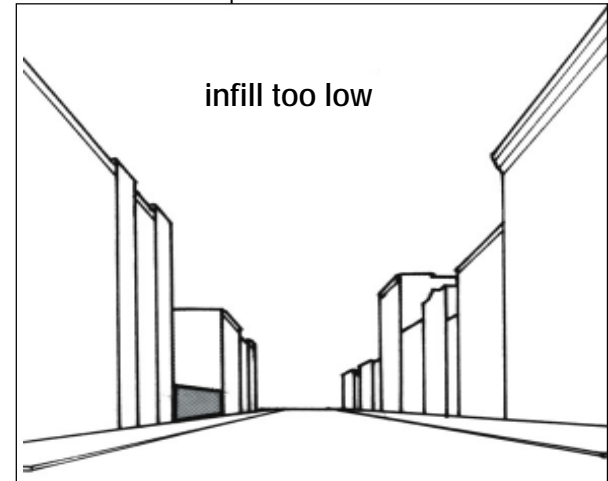

Design Guideline: Street edge continuity shall be re-established by infill development of vacant sites.

Design Principle: Missing building fronts along a blockface disrupts the quality of street as a place by allowing the enclosed space to leak out.

The urban quality of the District has much to do with the nature of the street. The key to this is the notion that building facades contain space. This is in contrast to the suburban or rural pattern of landscapes containing buildings.

Where buildings once stood within the Historic District, a number of vacant sites have been created. To re-establish the quality of the street these sites should be filled with new buildings of similar height and scale

facade height

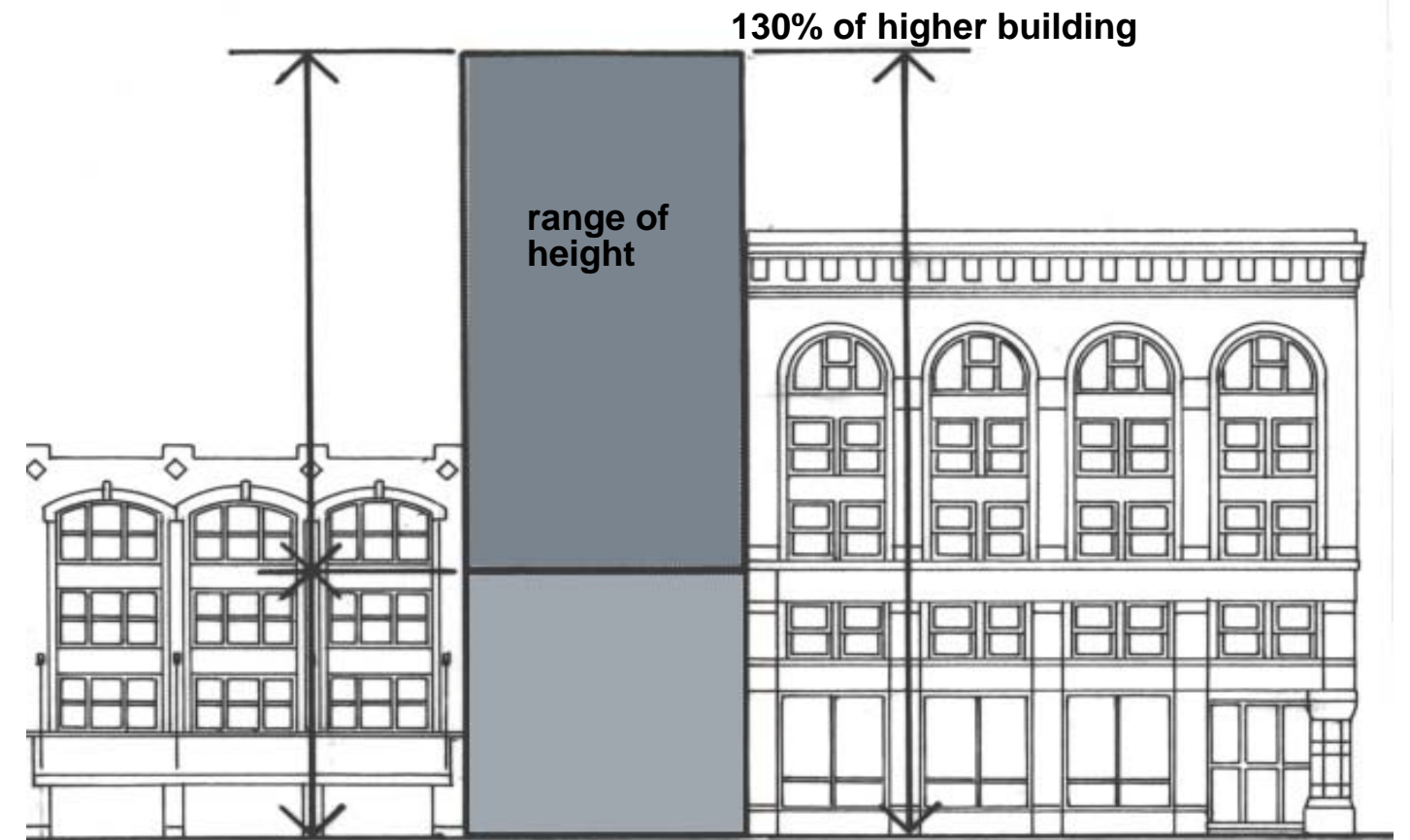

70% of lower building but not less than 30 feet

Height of New Facades

Design Guideline: The height of buildings within the Historic District shall be contained within the range of 70% to 130% of adjacent historic building heights along the street edge, but not less than three stories (30 feet).

Design Principle: Strong neighborhood identity is reinforced by a commonality of building forms referred to as an urban fabric.

The height of buildings in the Neighborhood varies widely from one story to ten stories. By relating the indicated percentages to the historic buildings a general continuity of height at the street edge is maintained. This will preserve the perceived scale of the buildings and extend the harmony of street spaces that exist within the Historic District. **Buildings extending through to adjacent streets shall conform on each street.**

Design Guideline: The height of buildings outside the Historic District shall comply with the guidelines on page 14.

*Design Principle: "On the whole, adjacent buildings should be roughly the same height."**

Historic District Corner Sites: For sites on intersecting rights of way of different widths the ARB will entertain a greater building height up to the lesser adjacent street width if of exceptional design quality and if building massing transitions to lower existing structures.

Exception: See page 37, Landmark Sites
* Excerpt from *A Pattern Language*, by Christopher Alexander.

FORM

back facades

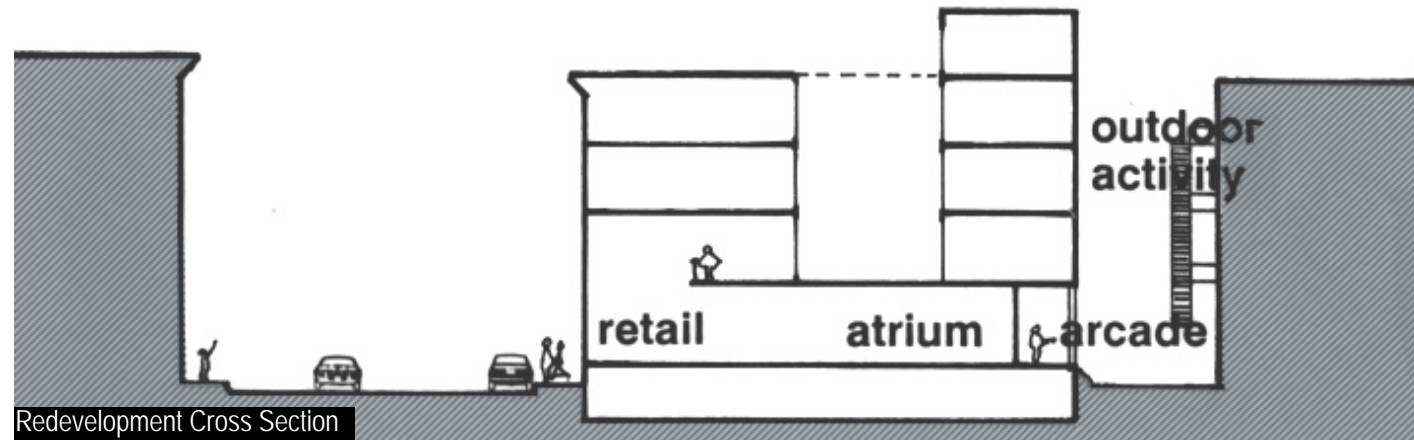
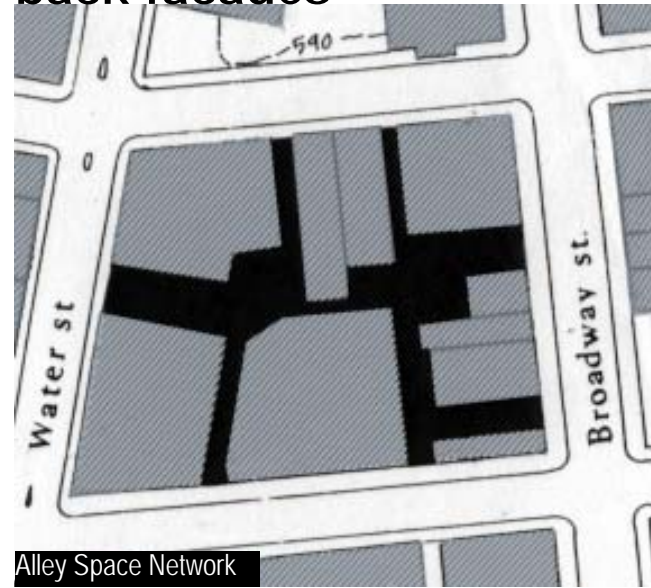

Design Guideline: New rear additions or rear facade modifications should be compatible with the historic character of the original facade.

Design Principle: This guideline does not suggest a repetition of the street architecture. Compatible designs which are clean, simple, and functional, and of a modern attitude could be equally appropriate.

Particular care and attention is necessary when making modification to improve service access to the rear of buildings or to improve loading dock facilities. Any such modifications shall maintain the essential character of the building and make use of materials similar to those used in the historic building.

There are several mid-block areas within the District as defined in the 1987 master plan where the rear areas of buildings form

potentially interesting secondary public places reminiscent of successfully revitalized areas in other American cities or in European cities.

To successfully develop these areas it is important to retain not only the volumetric character of the space, but to further enhance the exposed surfaces with some of the same visual richness which prevails throughout the rest of the District.

The interior and exterior public places thus created, offer opportunities for a variety of exciting new uses such as cafes, shops, and building additions with arcades, atria, and multi-level retail spaces.

exposed sides of buildings



Design Guideline: Where city ordinances and state building codes allow, side elevations on open sites should be treated as a facade compatible with the street facade.

Design Principle: Many structures within the Historic District have been razed. This has resulted in the exposure of the sides or party walls of the remaining buildings. These sides were not designed to be seen from the public streets and so were utilitarian in nature, generally unfinished in character, and often built with no windows or doors.

As the trend to adaptively reuse existing buildings for residential and other purposes continues, and if infill building on the vacant site is not anticipated, side faces will likely be altered. In these circumstances, the design of side facades should be carefully considered with respect to the street facade. This does not imply that the side facade should attempt to replicate the street facade but that they should be visually organized and unified. This may involve painting or other surface treatment.

Where new sidewall openings are created, respect for existing lintel heights, floor lines, window proportions, window type, and scale should be evident.

FORM

balconies



Unacceptable Facade Alteration



Acceptable Side or Rear Facade



Open Sidewall Balconies

Design Guideline: Within the BID District #2, the addition of projecting balconies to street facades of pivotal or contributing buildings (see page 28) is prohibited.

Design Principle: The historic facades of the Third Ward are a limited and precious resource.

Recent residential conversion of some important (pivotal or contributing), historic buildings in the District have yielded unsatisfactory facade alterations. In some instances applied balconies dominate the facades. In addition, the installation of balcony doors has permanently altered the facades fenestration pattern. In the worst cases historic facade ornament was sacrificed. These unfortunate results are convincing evidence that protection of historic street facade features is crucial to the neighborhood.

Since balconies have become almost a required amenity of urban residential living units, their location on side and rear, non-street facades of historic buildings, will be considered (see page 57). Here they may add much needed interest to blank walls. The following criteria apply:

- Proposed balcony additions shall not require the removal or in any way obscure or destroy existing facade ornament.
- Balcony railings should compliment the scale characteristics of the existing building and attachments shall be well integrated and carefully crafted.



Acceptable Recessed and Partially Recessed Balconies



Recessed



Design Guideline: For new construction, balconies shall be recessed or semi-recessed into the street facades.

Design Principle: Balconies provide an opportunity to animate the street setting and provide for informal surveillance of the street and therefore contribute to making streets safer.

Design options for integrating balconies into new building facade composition are far greater in number than for fitting them to existing facades.

By following the criteria below and the preceding railing criteria, proposed balconies can be approached but should not negatively detract from or overwhelm the visual qualities of the street facades.

From the larger context these physical amenities should enhance and add interest to the building's street facades. They should not by virtue of size and number screen or become the facade. Greater than 25% of overlaid area on street facades is prohibited.

- Individual balconies should fit within a vertical bay of the facade.
- Consistent with their functional history, balconies should be 5-6 feet deep, and allow space for several people.

FORM

penthouse additions



New Setback Penthouse



Penthouse Enhances Skyline



Penthouses Not Visible From Street

Design Guideline: Consistent with the Guideline for renovations and additions, (page 60), penthouse additions or additions that vertically extend the building's facades shall be respectful of the buildings existing street facades.

Design Principle: Penthouse additions or vertical facade extensions, increasingly popular in urban housing development of industrial loft building renovations, can contribute visual interest to urban settings.

By following the following design criteria, vertical modifications can be approached but should not negatively detract from or overwhelm the visual quality of the Third Ward's historic street facades. A clear visual break should occur between new and historic.

Occupied penthouse additions to pivotal historic structures shall be setback from the street facades such that the integrity of the historic street facade is seen as a separate volume from any new addition to the existing building. Two story penthouses may require a greater setback.

Consistent with the functional history of these roof forms penthouse additions should be simple and understated and avoid any attempt to mimic ornamented street facades.

vertical facade extensions



Acceptable



Not Well-Integrated



Unacceptable: Incompatible

Design Guideline: Vertical extension of facades classified as pivotal by the historic district designation is prohibited, see page 28.

The additions should also respect the expressed rhythm of the facade. Additions should compliment the scale characteristics of the existing building. Addition facades should adopt the proportions of the existing facade.

New construction penthouses should comply with Guidelines on pages 44 and 45.

Unoccupied roof access or mechanical equipment additions to pivotal historic buildings should not be visible from the sidewalk across the street from the main building facades.

In the larger context these physical interventions should enhance and add interest from the point of view of both skyline and roofscape appearance or from the point of view of enhanced street enclosure consistent with the guideline on page 14.

DESIGN PRINCIPLES

renovations and additions



Sensitive Addition: Iron Block Building, Milwaukee, Wisconsin

Design Guideline: New additions or modifications to an existing building should be consistent in rhythm, proportion, and scale with the existing buildings.

Design Principle: Attempting to replicate an existing historical facade when creating a new addition, often devalues the quality of the original building.

Just as it is important to consider adjacent buildings when adding an infill building to a vacant site, additions to existing historic buildings require the same consideration of expression lines; building heights, base, middle and top composition; and of rhythm, proportion, and scale.

This does not imply exact replication of the building facade but rather provides a basis for establishing visual continuity while allowing a modern interpretation of material, detail, and ornament.



Contemporary Approach



Post-Modern Approach



Modernist Approach

DESIGN PRINCIPLES

mechanical and safety equipment



Tanks



Tank Silhouette



Tacky Conduit

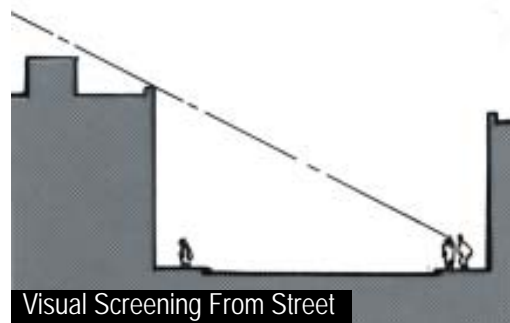

Visual Screening From Street



Interesting Tank Support

Design Guideline: Elevator motor rooms, water tank structure, etc. are essential components of the Historic Third Ward character and should be retained if structurally sound.

Design Principle: Unique historic rooftop elements continue to be an important visual part of the District skyline.

There remains in the District numerous examples of original rooftop mechanical elements such as sprinkler system water tanks, water tank structures, and elevator equipment rooms.

Together with the historic facades, ghost signs, typical fixed awnings, and corner columns these elements maintain a link to the past, and as such are a vital part of the character of the District. Such elements are often an integral part of the structure of the building and need to be maintained in good physical condition to avoid damage to other components of the building.

Design Guideline: Screening of new rooftop HVAC units is required.

New mechanical equipment

When new mechanical equipment must be located on roofs of buildings it should not be visible from the side of the street opposite the building.

Pieces of mechanical equipment, skylights, and other elements of the building that are exposed on the roof are anticipated and acceptable. All elements that are visible on the roof should be arranged in an orderly manner, particularly if the roof can be viewed from surrounding buildings.



Exhaust Vent



Fire Department Standpipe



Manufacturer's Processing Equipment

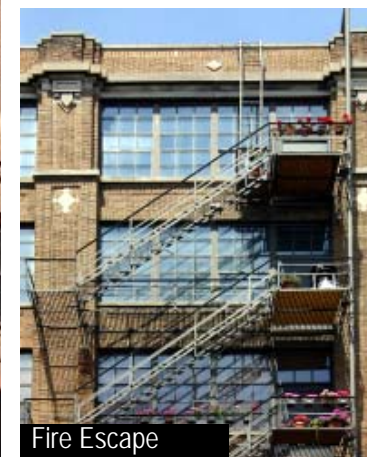

Fire Escape



Hose Connection

Design Guideline: Exterior fire escapes, ladders, standpipes, vents, etc. should be well maintained and painted to blend with the color of the building or painted black.

Design Principle: Utility and safety equipment on building facades should be inconspicuous and go unnoticed.

Many existing historic buildings in the District have original fire escapes and standpipes. In several historic Tax Act projects, the building owners have been required by the National Park Service to repair and maintain these elements. In other remodeling projects where these same items are to be saved, they shall be maintained and painted in as neutral and as non-intrusive a manner as possible.

Design Guideline: Utility meters, exhaust vents, etc. should be unobtrusive and are best located at the side or rear of the building.

In so far as possible, new utility services shall be installed underground. Metering devices and other mechanical items shall be located at the side or rear of the building. Location of these items on the front facade of the building is highly discouraged.

PRESERVATION OF NEIGHBORHOOD QUALITIES

building details materials public art

Introduction

As stated in the Secretary of the Interior's Standards for Rehabilitation, "Rehabilitation" is defined as *"the process of returning a property to a state of utility, through repair or alteration, which makes possible an efficient contemporary use while preserving those portions and feature of the property which are significant to its historic, architectural, and cultural values."*

Before any changes or additions are made to a historic building it is important to thoroughly understand the contribution of the existing conditions to the integrity of the historic structure.

To this end there is a need for building owners to undertake, or to commission, the necessary research to establish how the building was originally designed and constructed. This should be the starting point for all future changes. These steps should lead to a master rehabilitation plan for the building.

The guidelines which make up this section reflect the preservation issues most influenced by incremental changes over time. They are generally characterized in building details such as openings, storefronts, signs, and canopies, marquees and awnings. Guidelines are also presented for façade details related to surface treatment, ornamentation, painting, and color.

Although many of these alterations would not necessarily require the services of an architect, it is strongly recommended that professional design assistance be sought to ensure compliance with these guidelines. A master rehabilitation plan is strongly advised for pivotal and contributing buildings, so that incremental improvements are coordinated.

Relative to new construction, reference to these issues of building details and materials will help insure a good fit into this historic built context. Attention paid to these concepts will also aid in addressing the broader concerns of Section I Guidelines, pages 18-23 "Social Life of the Street."

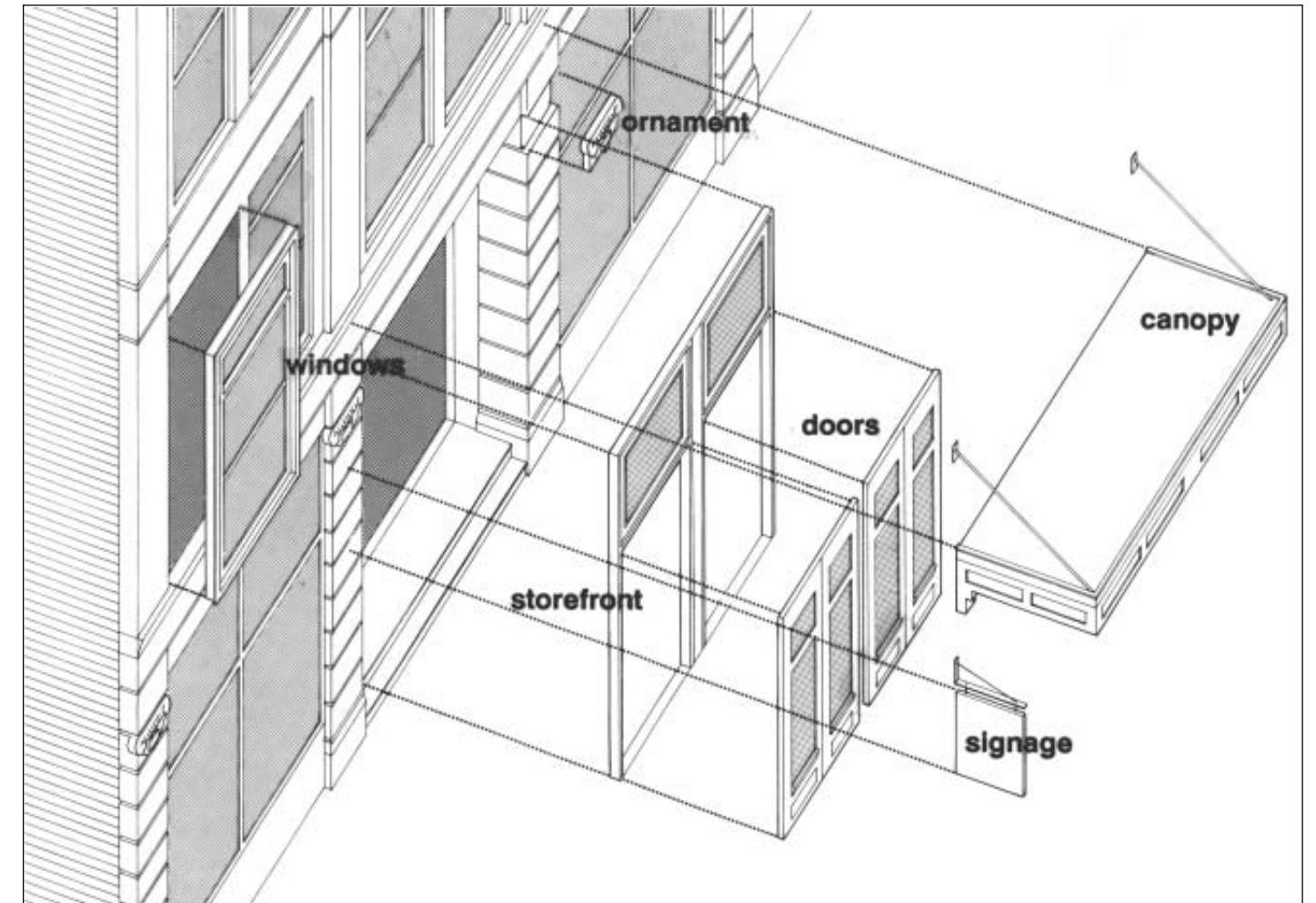

Building Facade Details

BUILDING DETAILS

windows and window openings



Historic Configuration
Different Configuration- Unacceptable



Enlarged/ Original



Tinted/ Undivided

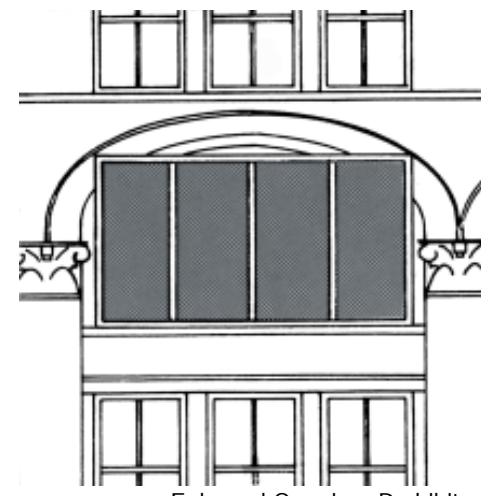

Enlarged Opening- Prohibited
Tinted and/or Undivided- Prohibited



Design Guideline: The replacement of windows and window openings should replicate the original configuration of solid (structure) to void (window).

The wide variety of design, placement, size, and trim make windows one of the more highly visible architectural elements within the Historic Third Ward. Windows should be preserved and protected against insensitive alteration and elimination. The proper handling of windows and their interior and exterior trim can add substantially to the quality of building rehabilitation.

Design Guideline: The blocking up of window openings or any portion of the window opening on the street facade is not permitted.

Historically, a range of different window treatments were used in the area. In the early 19th century, multi-paned, double hung wood sashes were used with simple sills and lintels of wood or stone. In the latter 19th century and early 20th century, larger pieces of glass became readily available as did more ornately fashioned sills and lintels of carved wood, cast iron, and cut stone.

Modifications to existing window openings and components must be carefully considered and will be closely scrutinized by the ARB.



Smaller Windows- Prohibited
Blocked Opening- Unacceptable



Prohibited Modifications



Large Window Openings



Partially Blocked Opening - Prohibited

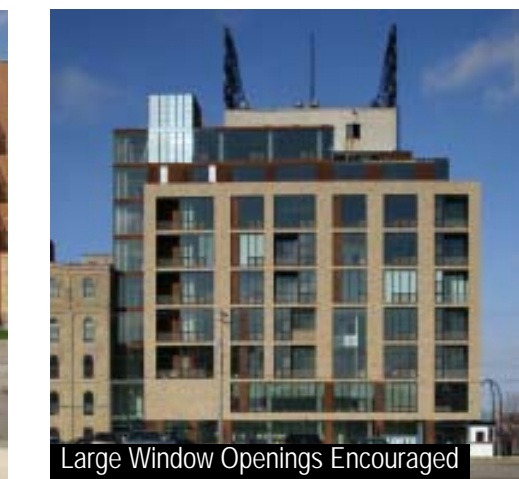

Large Window Openings Encouraged

Design Guideline: All window air conditioners shall be relegated to secondary facades of the building.

Existing windows and window openings should be retained. This should include the window sash, clear glass, lintel, sill, architraves, pediment, hood, and all hardware. Owners of buildings whose windows or window openings have been altered in the past to reduce the glass area or to provide larger picture windows shall be encouraged to restore these openings to their original sizes.

The original proportion of wall openings should be retained. The blocking of existing openings to accommodate standard sash and window sizes, to hide ceilings lowered beneath the tops of existing windows, or for any other reason is not permitted.

Design Guideline: New street facades should emulate the large scale window openings prevalent in the Historic District's commercial buildings.

Replacement windows should duplicate the original in design and materials. Tinted glass is unacceptable.

When necessary, aluminum windows used for replacement should match the robust cross section and color of original components. Natural or unfinished aluminum coloration is not recommended in historic building renovations.

The neighborhood's commercial buildings have large windows. All new construction should incorporate predominantly large window openings into the facade composition.



Historic Configuration



Retained Unused Entry



Fine Materials

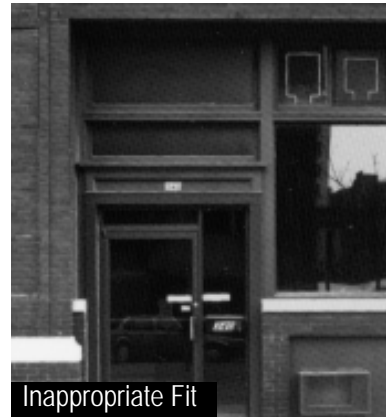

Inappropriate Fit



Prohibited Board Up



Lacks Ornament

Design Guideline: Doors and adjacent transoms or sidelights should display the same characteristics and scale as the original. The blocking-in of door openings is prohibited.

The proximity of doors and door openings to the user make doors a highly visible architectural element. Although closely related in size to human proportions, the doors of buildings in the Historic Third Ward are often oversized and appear in proportion to the building as a whole. The oversizing of doors combined with a richness of detail, the panelizing of the door, the incorporation of glass lites, and substantial and decorative hardware, established a scale relationship with the user.

Existing doors and door openings shall be retained, including the door frames, transoms, sidelights, glass panels, lintels, sills, steps, architraves, pediments, hoods and all hardware. Owners

Design Guideline: Doors along public ways are but one component of entrance transitions. Overhead protection, grade transition, and ornamentation shall be included in any consideration of doors and door openings.

of buildings whose doors and door openings have been altered in the past to reduce or enlarge the door openings shall be encouraged to restore these openings to their original size.

The original proportion of door openings should be retained. The blocking of existing openings to accommodate standard frames and doors is not permitted.

New development projects should maximize the number of doors and entrance transitions along public ways.



Quality Materials and Detailing



Preferred Transparent Door



Street Townhouse Solution



Integrated with Facade Design

Design Guideline: Garage doors along public streets are discouraged, but where necessary should add visual interest much like entrance doors.

Every effort should be made to avoid private automobile parking and parking entrances from along public streets.

Garage doors, however, are in some instances inevitable. These entries should receive the same careful design attention as other facade elements. It is preferable that they be relocated to alley locations. However, should it become necessary to locate them along public streets they should be understated or recessed, yet still carefully designed. Transparent doors are preferred.

BUILDING DETAILS

storefronts

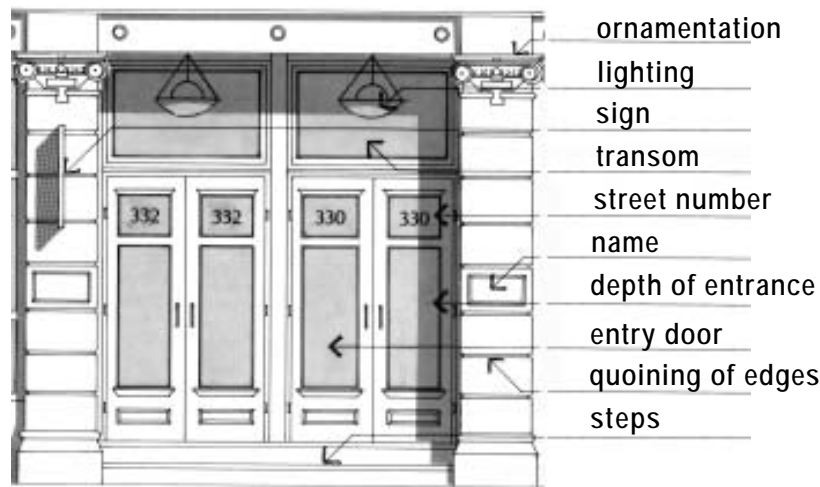

Richness of Traditional Storefront

Prohibited Blocked Up Front

Many Elements Well-Composed

Above- Unattractive Mix

Below-Many Elements - Good Relationships

Design Guideline: New or altered entries and storefronts should display a visual richness of detail to add interest to the base of the building and the street.

Design Guideline: Blocking up of storefront openings is prohibited. Blank street facades are prohibited.

Visual richness depends on the presence of visual contrasts in the storefront surface. At close range richness must be achieved by small-scale elements and subdivisions. Historic storefronts in the Third Ward are characterized by a balance between complexity and simplicity together with materials and construction techniques appropriate to the historic character of the District.

- entry door to store
- entry door to upper levels
- street number
- store windows
- bulkhead panels or windows
- transom windows
- entry sidelights
- steps
- canopies
- awnings
- signs

- change of materials
- ornamentation/details
- trim/molding
- quoining of edges
- door/window hardware
- lighting fixtures
- lighting quality
- size of opening
- depth of entrance
- multiple entrances
- layering of materials

Typical of historic storefronts is the presence of many design and building elements that reinforce the importance of the storefront area of the building. These include:

- name of store
- sitting wall
- handrailings

- window displays
- entry ramps
- planters & vegetation

Storefronts of new buildings should exhibit increased richness and ornamentation consistent with the building's architecture. This might include new, non-traditional elements or construction technologies.

BUILDING DETAILS

storefronts

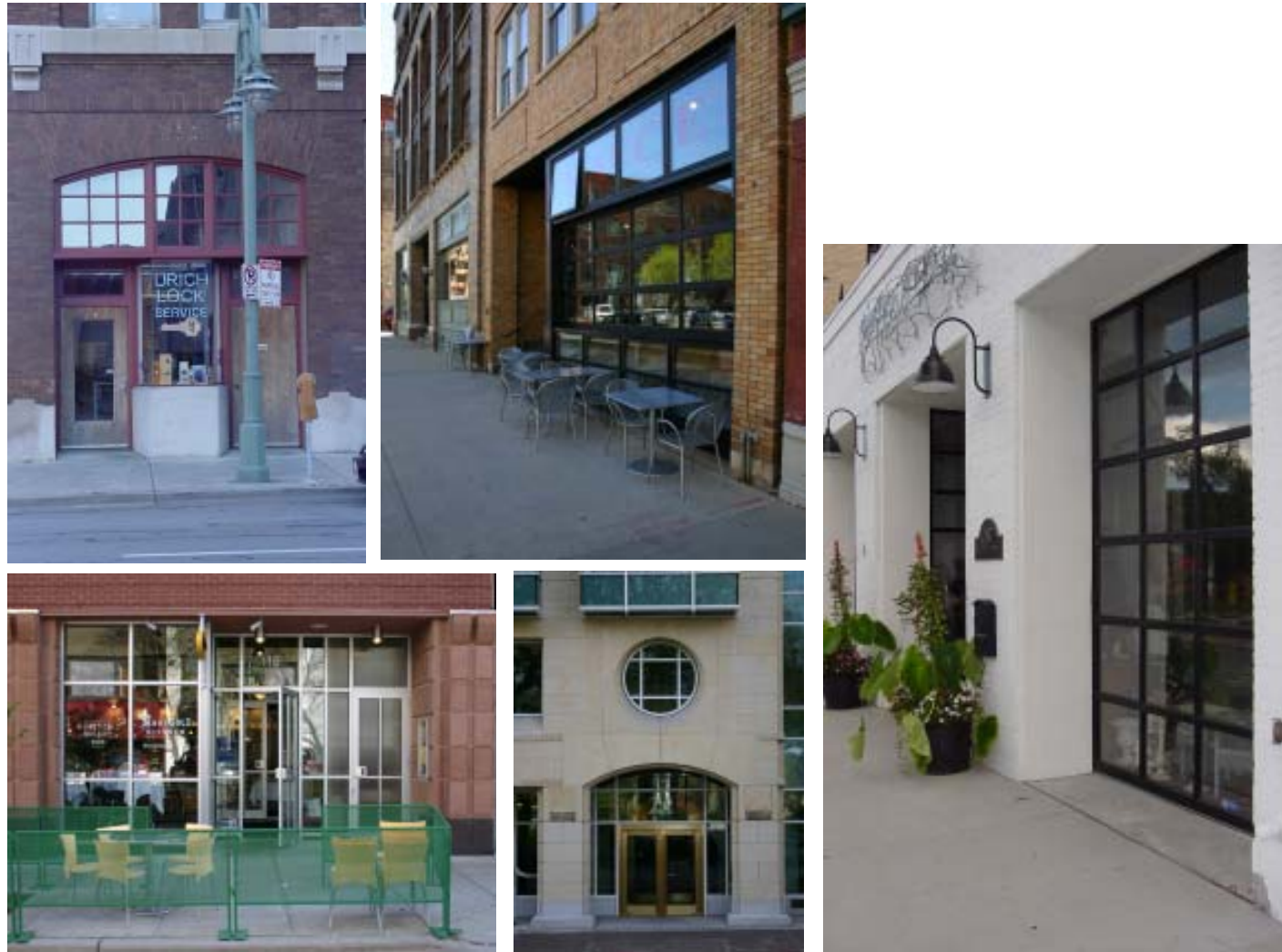

In the many fine storefront examples above, richness depends on the number of visual elements present in each storefront and on the relationships between them. As the number of elements in a given storefront increases so does richness.

By the time a storefront contains about five elements, there is plenty of choice of things to look at so the surface seems rich. However, when the number of elements exceeds about nine, care must be taken to avoid visual confusion.

The number of elements is important, but is equally critical that the elements work together, that they are well proportioned, that they are compatible in style, material, texture, and color, and that they are carefully detailed.

For historic buildings preservation by replication is preferred, contemporary interpretations, perhaps relating to the business type, are possible. However, such proposals will be closely evaluated by the Architectural Review Board.

BUILDING DETAILS

security grills and gates



Finely Crafted Security Gate



Prohibited Gate



Ornamental Grill



Prohibited Security Grill

Design Guideline: Fixed, collapsible and rolling security grills and gates are prohibited on street and riverfront display windows and doors.

Security grills and grates on storefront windows and doors portray a negative image that is detrimental to the neighborhood as a safe place to visit, work, shop, and live. Architectural iron work consistent with the particular building's facade style and character may in some cases be an acceptable alternative subject to approval by the Architectural Review Board and compliance with city codes and ordinances.

BUILDING DETAILS

building signs



1- Commercial Character



2- Visual Chaos

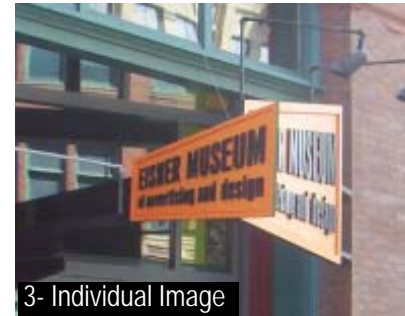

3- Individual Image



4- Business Signs Convey Info.



5- Building Signs Convey Info.



6- Building Occupant List

Design Principle: Exterior signs should be located within the base of the building with concern for the appropriateness of location, size, color, lighting, and design quality.

1 Sign ordinances are complex and can lead to an oversimplification of the potential visual interest of a city. Signs are an integral part of the commercial character of a neighborhood. At the same time, the lack of any control can lead to visual chaos.

2 The intent of these guidelines is to allow for great variety within some controlling parameters.

3 The base of the building is the most visible part of the building for both pedestrians and motorists. To be effective, signs must call attention to the business and create an individual image for the store. But signs also contribute to the overall

image of a district, adding variety and liveliness to both building facades and streetscapes. A thematic approach includes such commonly shared considerations as sign message, location, size, color and lighting.

Sign Message

4 Business signs should only include the formal name of the business, the nature of the business, and the address. Advertising of brand names is discouraged. Avoid an accumulation of service club affiliations, credit card decals, and other sign clutter.

5 Building signs should include the name of the building and the street address of the property. Professional office buildings may list the occupants of the building.

6



8- Color Compatibility

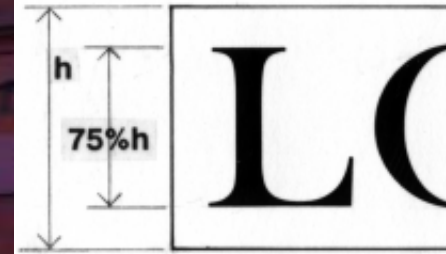

7- Letter Size



9- Prohibited Illumination

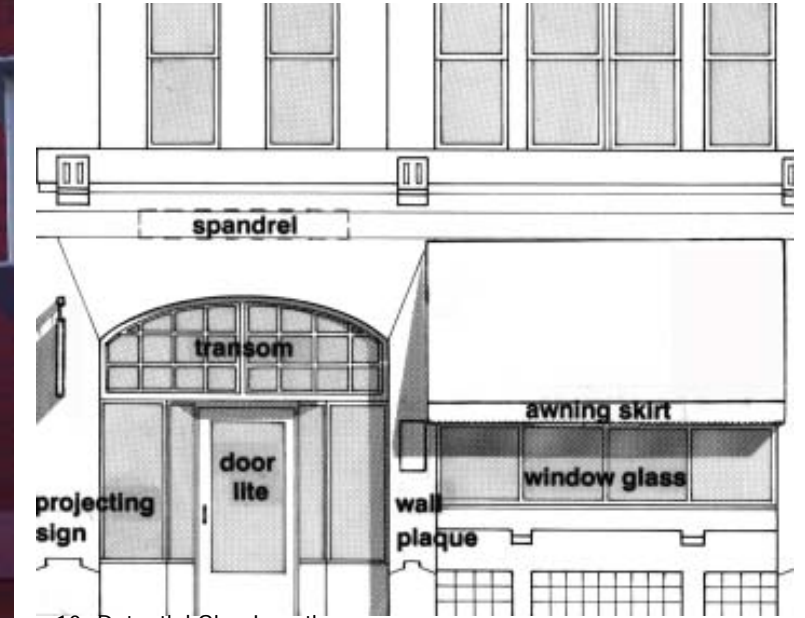

10- Potential Sign Locations

Style and size of letters:

7 There are many letter styles available. The primary lettering styles used on 19th century signs were serified. These are strongly recommended in the Historic District. However, a letter style should be chosen that is easy to read and that represents the image of the business it is presenting. The maximum height of the letters shall not exceed 75% of the height of the background on which they appear.

8 Color:

It is recommended that colors that are compatible with the coloration of the building facade and the nature of the business be chosen. No more than three colors should be used, plus white, black or an accent color. Fewer colors is fine.

Fluorescent (day-glo) colors are not permitted. There are no other restrictions on color although colors that are evocative of the historic character of the Third Ward are recommended in the Historic District.

Illumination:

9 No back-lit, flashing, or moving signs are permitted.***

10 Sign Location and size:

Signs shall be located on the spandrel panel of the building immediately above the storefront, within the transom of the door or storefront, on door or window glass, on wall areas adjacent to the door, on the valance/skirt of awnings, or on projecting signs hung within the base zone of the building.

BUILDING DETAILS

building signs



1- Spandrel Signs



2&3- Transom Signs



7- Pilaster Sign Too Wide



4- Transparent Signs in Windows



5- Sign Plaques



6&7- Sign Plaque Compliments Architecture

1 Spandrel panel signs:

The size of signs on the spandrel panel shall be such that they can be contained within a structural bay of the building, but shall not exceed twenty feet in width. The height of the sign shall be no more than 75% of the height of the spandrel.

Transom panels signs:

2 Transom area above the door or display windows shall not be covered by opaque signs or panels. If the transom is broken down into a number of small panels, sign location should respect and not obscure the individual panels. Signs in the transom area shall not exceed 65% of the width of the panel or 75% of the height of the panel. The height of letters shall not exceed 18 inches.

Display window signs:

3 Display window signs applied directly to the glass shall consist only of lettering and/or a symbol without an opaque background. On the display window, such a sign shall not cover more than one fifth of the area of the glass panel.

Window signs should not obscure the display area. The color of the letters should contrast with the display background. Light colored letters or gold leafed letters with dark borders are effective.

4 Signs used inside of and unattached to the display windows may have opaque, translucent, or transparent backgrounds and should be limited to no more than nine square feet in size.

Column, Pier, or Wall Signs (Sign Plaques):

5 Exterior signs surface mounted on building columns, piers, or walls are herein referred to as sign plaques. They are a traditional ornamental sign type very much in keeping with the District if prepared in metal, stone, or other approved exterior materials.

building signs



8- Banners



9- Projecting Sign Attached at Structural Piers



11- Brackets

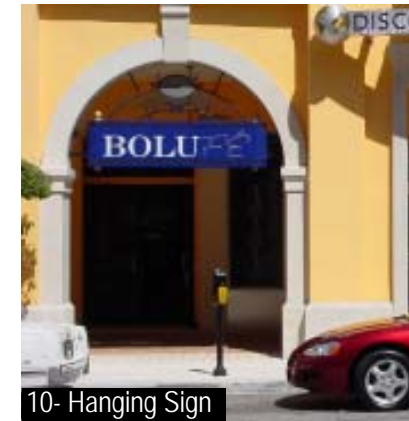

10- Hanging Sign



12- Appropriate External Illumination



13- Prohibited Internally Illuminated

6 More contemporary versions of this type will be considered if they reflect the nature of the business and respect the architectural composition of the facade. This sign type should be mounted at eye level on a building column, pilaster, or wall.

7 They should not exceed 75% of the width of the column, pilaster, or wall segment and the sign plaque dimensions should define a proportion similar to other proportions evident in the facade. While one sign plaque per column is preferred, several businesses could be represented as modules of a system subject to ARB approval.

8 Banners/Projecting Signs

9 A projecting sign should be mounted on the structural piers of the building. They should project no more than four feet from the face of the building. Hanging signs shall be no lower than the height above the sidewalk permitted by the Building Code and no higher than the base of the building.

11 Brackets and other methods of attachment shall be considered part of the design proposal and should be designed to be interesting and compatible with the building or business. These brackets are controlled by the City of Milwaukee Code of Ordinances. All projecting signs shall be anchored to resist destabilizing by wind action.

12 All projecting signs should be externally lit. External light sources should be shielded from viewers on the street to prevent glare.

13 No internally-lit, flashing, or moving projecting signs are permitted.***

***See City codes and ordinances for type B signs.

BUILDING DETAILS

building signs



1- Street Corner Signs



2- Awning Signs



4- Temporary Signs



3- Logo Location Acceptable

Street Corner Signs
 1 Historically, street corners are architecturally emphasized. Signage too often marked the corner with vertical emphasis. This sign type shall meet city standards for height from sidewalk, and ARB standards for brackets and design quality, but will be allowed above the base of the building.

Awning signs:
 2 Awnings can also serve as signs with contrasting letters painted or sewn onto the valance or skirt of the awning. Usually six to eight inch letters are sufficient. Lettering on the main awning area is not permitted, although one business logo in this location could be considered.
 3

Temporary advertising signs:
 Temporary advertising signs attached to buildings and display windows should be limited to 30 days of display time.

4 Temporary signs are prohibited on the exterior of buildings. It is acceptable to display these signs in windows inside of the building.

5 Banners are temporary, six month, exterior signs subject to the established ARB review process. Installations must be approved.

6 Real estate company "For Rent" or "For Sale" signs may be mounted prior to ARB review if an application is submitted simultaneously. The Architectural Review Board will review these applications within 30 days.

building signs



5- Temporary Banner



9- Prohibited Billboard



6- Temporary 'For Rent' Sign



8- Prohibited Freestanding

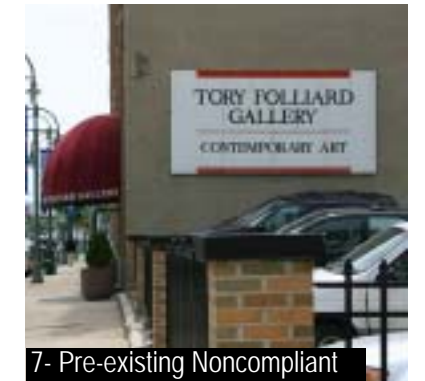

7- Pre-existing Noncompliant

Real estate companies are advised to be aware of the guidelines affecting signage in the Historic Third Ward and display signs in compliance with the guidelines. Signs found to be noncomplying shall be brought into compliance within 30 days. These signs are regarded as limited term applications and may be reviewed after 6 months

Pre-Existing Noncompliant Signs
 7 Preexisting nonconforming signs are grandfathered for a limited period of time but shall not be repainted, resurfaced, or otherwise improved without being brought into compliance with the design guidelines. Existing non-conforming signage shall be removed as a condition of approval for new signage. The removal of preexisting nonconforming signs shall be mandatory five years from the date these guidelines are ratified. Ghost signs shall be the lone exception.

8 The urban character of the Third Ward neighborhood suggests that freestanding signs are undesirable. These types of signs are typical in suburban conditions, but are prohibited in this urban neighborhood.

Billboards
 9 Billboard signs are prohibited.

Exceptions: Signature sites and signature (cultural) uses are eligible for exclusion from signage guidelines subject to the ARB's discretion.

BUILDING DETAILS

sidewalk signage



Streetscape Banners



Good Graphics



Creative Solutions

Design Guideline: Street banners and sidewalk signage shall exhibit professionally designed graphics.

Banners: The streetscape project has created a unique opportunity for advertising. A large number of Third Ward lamp posts were designed to allow easy mounting of banners. Streetlight banners can have a strong impact on the image of the neighborhood and therefore must be of the highest possible aesthetic quality. The Historic Third Ward may make available individual lamp post locations for promoting events in accordance with policies and procedures established by the Association. Banners will be reviewed carefully in terms of concept, size, shape, color, graphic impact, materials, and other technical factors as well as conveying the name and sensibility of the business or event advertised.

Sandwich Boards: Sidewalk sandwich board signage should be composed and constructed with care giving consideration to concept, size, shape, color, graphics, and materials, as well as conveying the sensibility of the business. These portable signs shall be designed to be structurally stable under all wind and weather conditions and other impact forces. They shall not be braced by or otherwise attached to any other streetscape element, (lamp post, bollard, parking meter, etc.) and shall be removed from the sidewalk during non-business hours. The size of any one sign face shall not exceed 3 feet wide by 5 feet tall. In addition, sidewalk sandwich board signage is subject to applicable City of Milwaukee Codes and Ordinances.

other signs



Produce Market



Farmers' Market



Sidewalk Display

Design Guideline: The displaying of merchandise on public sidewalks is encouraged where sidewalk widths permit public circulation and merchandise display.

Displaying of merchandise on public ways is in keeping with the principles presented and is a potent "sign" of commercial activity. It encourages pedestrian activity and social life on the street. However, care should be taken to allow a minimum clear passage of 60" for pedestrians including those in wheelchairs. Displays should be orderly, attractive and secure under all wind and weather conditions. Be advised that sidewalk display of merchandise is also subject to applicable City of Milwaukee Codes and Ordinances.

BUILDING DETAILS

canopies, marquees, and awnings



Original Metal Awning



Traditional Awning



New Fabric Type



Shelters Cafe



Contemporary Awning



New Metal Awning



Awning Fits Bay

Design Guideline: Canopies and awnings shall reflect the door and window openings or structural bays of the building.

Design Guideline: For historic buildings, use traditional shapes and materials typical of the turn of the century.

Canopies, marquees, awnings, and hoods are a typical design feature found on turn-of-the-century buildings of the District. Canopies and awnings are for the protection of pedestrians and for the shading of retail windows.

Stationary fabric awnings: An awning of stationary design with a pipe or steel tube frame, and covered with fabric.
Fixed awnings: A rigid roof-like shelter sloping and draining away from the building.

There are several variations of canopies and awnings which are defined in detail in the *Milwaukee Code of Ordinances*. These can be summarized as follows:

Canopy types:
Canopy: A rigid, flat roof-like structure, sloping and draining towards the building.
Hoods: A small rigid roof-like structure erected only over the entrance to a building.
Marquees: A large rigid, flat roof-like structure erected only over the entrance to a building.

Awning types:
Movable awnings: A retractable, roof-like shelter constructed to permit being rolled, collapsed, or fold back to the facade of the building.



Entrance Marquee



Contemporary Glass Canopy



Corner Canopy



Contemporary Glass Awning

Design Guideline: Awnings and canopies should enhance the expression of the building entrance and add a high quality element to the streetscape.

Design criteria:
Awnings shall be of the traditional sloped configuration rather than curved, vaulted, or semi-spherical.

Standing seam roofs for fixed awnings are preferred to corrugated metal awnings. Glass or translucent awning roofs are encouraged. Corrugated fiberglass and asphalt or wood shingle fixed awnings or pseudo-mansard roofs are not permitted.

Awnings shall be made of canvas or Neoprene impregnated fabric. Vinyl awnings are not permitted.

The underside of an awning shall be open to expose the structure. Soffit panels are not permitted.

New buildings are encouraged to consider the inclusion of a canopy, marquee or hood to enhance the entrance bay of a building.

Internal lighting of awnings is not permitted.

All effort should be made to retain and restore existing canopies, hoods, and marquees.

BUILDING DETAILS

building lighting



Design Guideline: Exterior and facade lighting shall be well-integrated as a design element to meet the concerns outlined herein.

Design Principle: The Third Ward offers a variety of activity at night. Building lighting offers opportunities to draw attention to businesses, to enhance a building facade's features, and to offer security. A carefully studied lighting design can achieve these goals, enhancing the District after dark.

Decorative light fixtures should be selected to harmonize with the building. The size, shape, material, and style of the fixture must be considered. Building flood and accent lighting fixtures should be as small and inconspicuous as possible--hidden from view by existing architectural elements whenever possible. The placement of fixtures, along with the lighting pattern and color, must compliment the building.

Avoid the use of exposed conduit and raceways on the exterior of the building. If such elements are unavoidable, place them in locations that would be least visible to the pedestrian and painted to match the existing, surrounding materials.

Good color rendition is an important consideration and is a function of the color of the lamp used. Incandescent and Metal Halide offer the best color rendition. The type of lamp should be chosen to enhance the building material and color. The use of neon lighting is closely scrutinized and limited to only the most compelling applications.



Minimize glare and spillage from lighting. As with lighting for signs, light sources are to be shielded from direct view. Spillage into adjacent buildings is undesirable. Light should be directed to enhance and dramatize architectural features.

Effective building lighting design requires technical expertise. The anticipated effects of a proposed lighting scheme must be carefully studied and clearly demonstrated visually through the use of traditional or digital rendering prior to approval. Given the limitations of graphic representations, adjustments may be required after the initial installation.

Maintenance is a critical element of a building's lighting. Burned out lamps or tilted fixtures make the building lighting a detriment to the building and the District.

Note: Text is edited from original research prepared by Chris Rute.

MATERIALS

surface treatment and finishes



Brick and Terra Cotta



Metal Surfaces with Architectural Intent



Catching the Sun



Stone Veneer



Inappropriate Resurfacing Material



Green Wall

Design Guideline: New construction and alterations to existing buildings in the Third Ward neighborhood should use materials which are sympathetic to the historic industrial character. These materials are typically brick, stone, terra cotta, glass, fabric, and metal.

Materials that do not compliment those already on the building facade should be avoided. The technique of production and assembly of the typical materials makes a major contribution to the richness of surface character. Retain original masonry and mortar whenever possible. Existing surfaces shall not be covered with other materials. Where such surface coverings have been previously installed, building owners are encouraged to remove them and to restore the underlying original surface.

When repairing or replacing deteriorated materials with new materials every effort should be made to duplicate the old as

closely as possible. The use the new masonry material should match similar materials used elsewhere on the building in texture, color, size, and coursing. The use of materials such as fiberglass, plastic, foam products, stucco or EIFS, concrete block, or concrete formed to imitate either brick or stone is not permitted on facades. Stamped concrete may be used on walks, etc.

The surface cleaning of structure should be undertaken with the gentlest means possible. Sandblasting and strong chemical cleaning methods that will damage the historic building materials should not be used.

MATERIALS

ornamentation and trim



Modulation of Light and Shadow



Texture and Scale

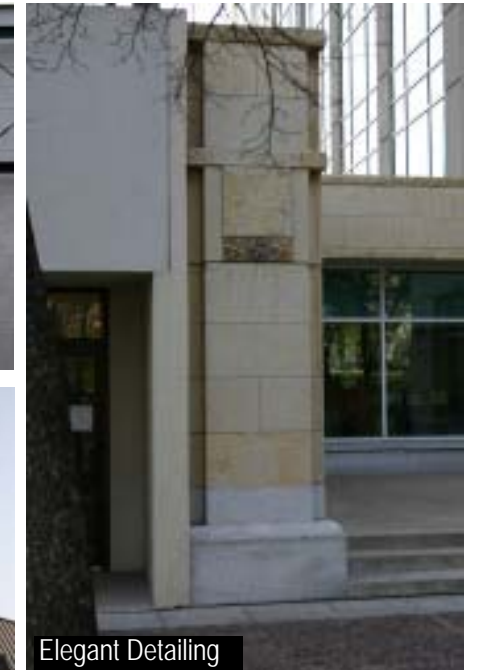

Elegant Detailing

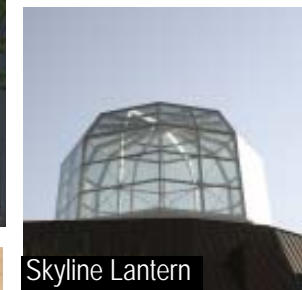

Skyline Lantern

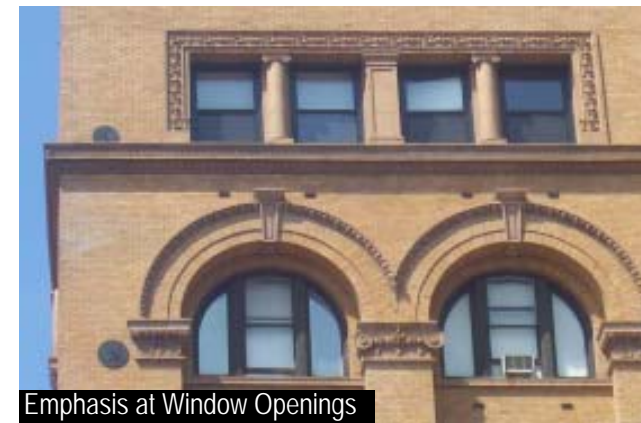

Emphasis at Window Openings



Enhancing Arrival

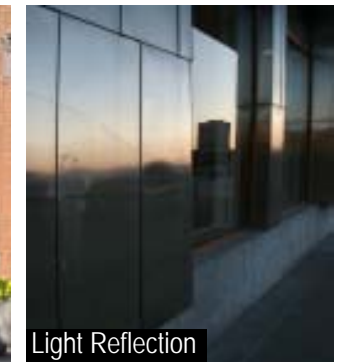

Light Reflection

Design Guideline: Existing masonry ornamentation and trim of Historic District buildings shall be preserved. On new construction, ornamentation should be an integral part of the design to enhance the visual richness of buildings in the neighborhood.

Protection of historic architectural characteristics is fundamental to protecting aesthetic, cultural, and economic value in the District and must remain a regulatory priority.

In the past, close-range richness of detail was common and affordable. Removing architectural features such as cornices, brackets, window architraves, doorway pediments, columns, etc. is not permitted.

Damage to ornamentation or surfaces for sign supports, balconies, mechanical equipment, or other attachments shall not be permitted.

painting



Painted Sidewall



Unpainted Alley Wall

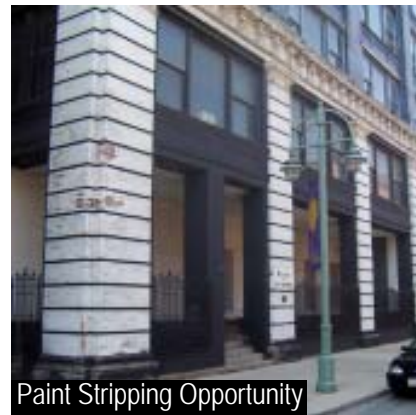

Paint Stripping Opportunity

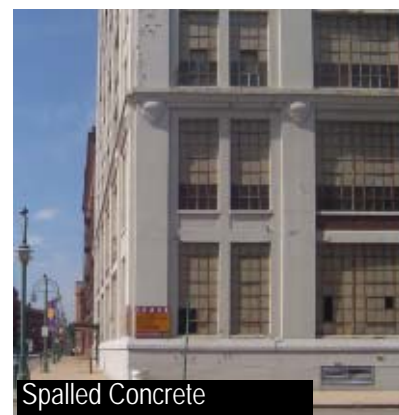

Spalled Concrete

Design Guideline: The painting of major street facades is not recommended. However, it is recognized that in some instances painting of the surface may be advisable.

Many of the existing historic structures in the District have been painted. Although this is not ideal it often serves to conceal earlier inappropriate or inadequate maintenance or irreversible changes that have led to unsightly surface conditions.

Where masonry requires replacement and the original color or size cannot be matched, painting serves to unify the surface color. Surfaces that are damaged by spalling may require cleaning and patching that again can be unified by painting. Painting of masonry for purely cosmetic reasons is not recommended. Masonry structures or parts of buildings that have been painted for decorative effect should have the paint removed and returned to their natural color.

Side and rear walls of buildings that show scars of removed adjacent structures or additions can be painted or otherwise treated to minimize this effect. The paint color of side and rear walls should blend with the color of the street facade.

Ghost signs and painted advertisements from an earlier era occur infrequently. They were a part of early twentieth century life and record a memory of previous commercial activity and graphic style. All ghost signs should be retained. See page 90.

color



Paint Colors Add Detail



Minimum Color Palette



Contemporary Color Palette

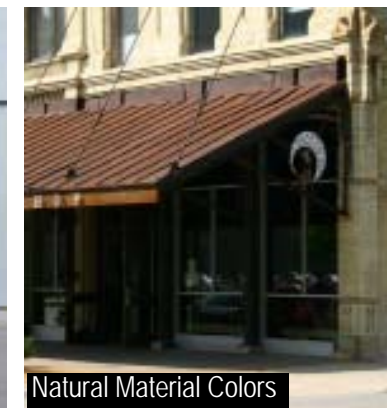

Natural Material Colors



Calling Out Ornament

Design Guideline: The colors used in the Historic Third Ward should be traditional muted tones and should be derived from the existing natural colors of the facade materials.

Presently, the historic area is characterized by buildings that are painted or that display the color of the material from which they are constructed. The predominant brick colors are reddish-brown in tone with a lesser number of lighter or cream brick coloration. Some amount of gray stone occurs within the bases of the buildings as does glazed terra cotta. In general, these materials should be left unpainted and cleaned. Details to be painted—window sashes, storefronts, trim, etc. — where possible, should be repainted based on the original colors discovered by careful removal of outer paint layers.

Intense colors can detract from a harmonious design, light colors bring out details, while dark colors obscure them.

Select colors for trim that contrast with the brick or other adjacent materials, for example, dark versus light, but in the same color range. To further enhance the architectural qualities of building, the number of colors should be kept to a minimum.

Repainting with colors which cannot be validated through research as being appropriate to the period and style of the historic structure is not recommended.

New buildings shall also adopt the design approach of expressing the natural color of the stone and masonry materials used.



Original Ghost Sign



Punctured But Retain Ghost Sign



Cornice Sign Now Prohibited

Design Guideline: All existing ghost signs should be retained. New painted masonry wall signage is prohibited.

Ghost signs, these painted advertisements from an earlier era, occur infrequently. Painted directly on building masonry side walls, they are an authentic remnant of early twentieth century life and record a memory of previous commercial activity and graphic style. All ghost signs should be retained and allowed to age gracefully in their original form. Ghost signs shall not be repainted or otherwise improved. This guideline shall not preclude building maintenance that may involve masonry restoration.

We recognize this sign type under these guidelines is equivalent to an endangered species doomed to extinction. However, given the renaissance of the Historic Third Ward as a neighborhood, as opposed to a warehouse district, more suitable modes of advertising are in order.



Design Guideline: Wall murals are an encouraged artform.

Wall murals are encouraged as an artform. Because of their size and potential impact on the image of the district, these graphic illustrations must be of the highest possible aesthetic quality. Proposed projects must be submitted to the Architectural Review Board. They will be reviewed carefully in terms of concept, technical factors, experience of the muralist, durability, and location on and integration with the architecture of the host building. Subject to approval of the ARB, graphic acknowledgment of sponsors/patrons is acceptable. Advertising is unacceptable.

Design Guideline: Public art is encouraged.

This neighborhood is identified as the home of the creative class. While MIAD, Milwaukee Institute of Art and Design, most predominantly represents that community persona, the new neighborhood plan offers increased opportunities for public art. Each installation is subject to ARB approval.

BIBLIOGRAPHY

Further Reading:

Alexander, Christopher, Sara Ishikawa, and Murray Silverstein. *A Pattern Language*. New York: Oxford University Press, 1977.

Bentley, Ian, Alan Alcock, Paul Murrain, Sue McGlynn, and Graham Smith. *Responsive Environments*. New York: Butterworth, 1985.

Broil, Brent C. *Architecture in Context*. New York: Van Nostrand Reinhold, 1980

Ching, Francis D.K. *Architecture: Form, Space, and Order*. New York,: Van Nostrand Reinhold, 1979.

Design Guide For Residential Areas. Colchester, England: County Council of Essex, December 1973.

Jacobs, Allan B. *Great Streets*, Cambridge, MA: The MIT Press, 1999.

Jacobs, Jane. *The Death and Life of American Cities*. New York, NY; Random House, 1961.

Katz, Peter. "What Makes a Good Park." *Architecture* August 1995: 43-47.

Keeping Up Appearances: Storefront Guidelines. Washington, D.C.: National Trust for Historic Preservation, 1983.

Leccese, Michael. Kathleen McCormick. *Charter of the New Urbanism*, New York: McGraw-Hill, 1999.

Main Street Guidelines; Awnings and canopies on Main Street. Washington, D.C.: National Trust for Historic Preservation, 1987.

Main Street Guidelines: Signs for Main Street. Washington, D.C.: National Trust for Historic Preservation, 1987.

Piwoni, James. *Riverwalk Design Guidelines for the Historic Third Ward District*. Milwaukee, WI 1998.

Piwoni, James. *Third Ward Neighborhood Planning Guidelines*. Milwaukee, WI. 2001.

Further Reading:

Piwoni, James, Karen Mierow and Michael Maierle. *Third Ward Neighborhood Comprehensive Plan*. Milwaukee, WI 2005.

Piwoni, James; Reed, David; Ryhn, Doug. *Design Guidelines for the Historic Third Ward District*. Milwaukee, WI 1990.

Standards for Rehabilitation and Guidelines for Rehabilitating Historic Buildings. Washington, D.C.: U.S. Department of the Interior, National Park Service, Revised 1983.

Trkla, Pettigrew, Allen & Payne; Nagle Hartray & Associates; and Metro- Economics. *Historic Third Ward, Milwaukee, Wisconsin; Urban Design and Development Potential Study*. Milwaukee, WI 1986.

APPENDIX

river elements

Design Principle: The Riverwalk in the Third Ward is an artistic interpretation of the city's infrastructure and its relationship to the Milwaukee River as an environmental corridor.

The Historic Third Ward Riverwalk is designed to provide new opportunities to experience the Milwaukee River and its relationship to the city and its people. It is an area where history as well as the future of the river can be explored and imagined. The infrastructure of the city, its highways, bridges, water mains, storm sewers and their relationship to the city are featured in the design.

The walk is primarily a wood boardwalk built on heavy timber framing out over the river. Its built close to the water providing a new and different perspective of the river. The river's edge is landscaped with vegetation indigenous to Wisconsin.

The following material specifications are included to assist in the design of new connections:

Materials and Typical Details

The design of the Riverwalk has both a rich and unique design vocabulary. It is intended that adjacent private property is developed in the future to both enhance and complement the design. The best case would be that the adjacent materials match in an exacting manner.

Accessible Connections

The Historic Third Ward Riverwalk is continuously accessible. Future ADA connections to the Riverwalk are anticipated and encouraged. It is also very important that the design of the connections blend or match with all aspects of the design vocabulary established by the initial phases of the HTW Riverwalk design.



ADA Ramp

Boardwalk

The walking surface of the boardwalk is a very dense, sustainable ironwood known as Ipe (Tebeuia Lapacho). The standard decking profiles used are 5/4"x6" and 2x8" nominal boards with eased edges. Any new sections of walkway must be 8'-0" clear, minimum. Any private access connectors (ramps, steps, etc.) should be 4'-0" clear, minimum. Decking is to be secured using stainless steel decking screws with vandal-resistant heads. Steps and ramp surfaces should utilize a "non-slip" routed surface board. No sealer or stains are used, the wood is allowed to naturally transition to a silvery-grey color.



Walking Surface

Benches

Simple substantial ironwood 12"x 12" x 5 foot benches define resting points along the riverwalk. Benches are typically arranged in groups of three. Benches may be substituted in lieu of the metal handrail system as an edge treatment with the approval of the various review agencies. Benches used in this manner should be closely spaced with a separation of approximately 6".



Benches

Structure

The primary structure of the Riverwalk is heavy timber. The material used on this project is Parallam, manufactured by TrusJoist MacMillian. Heavy timber members have been treated with Penta oil preservative to provide a long lifespan. All connections between the members are made with stainless steel brackets.



Support Structure

Handrail

The handrail comprises painted steel vertical supports and top rail, infilled with a stainless steel mesh. The posts are fashioned in a ladder-like manner and attached, if possible, directly to the heavy timber structure. Top rail should be 2" in diameter. Where the walkway curves, the top rail should be curved to match. The handrail system is to be painted with a high-performance paint system that consists of an inorganic zinc-rich primer, a black top coat and a semi-gloss clear coat finish. The stainless steel mesh infill panel is the X-Tend product, manufactured by Décor Cable. The mesh is threaded over braided stainless steel cable or rod depending upon the walkway condition.

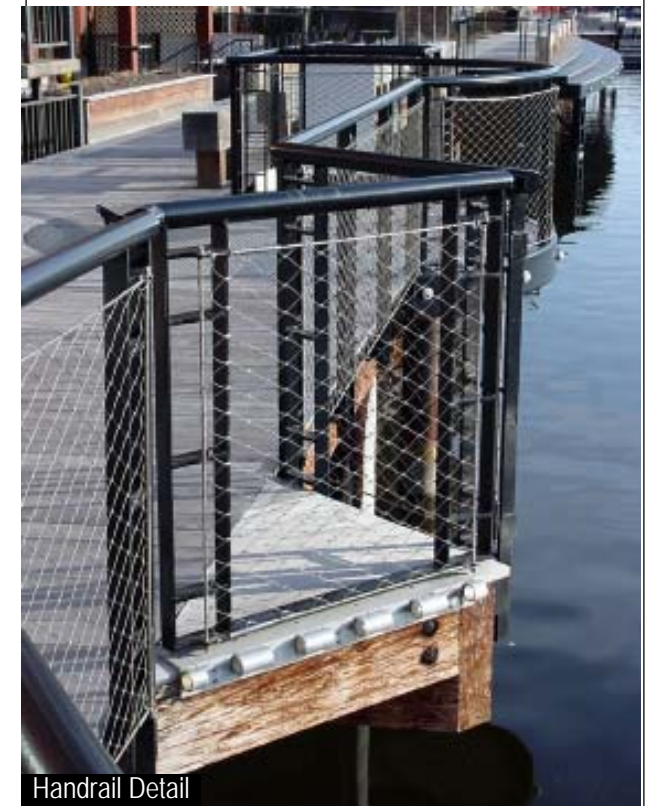

Handrail Detail

APPENDIX

river elements

Edge Elements

The indigenous landscape defines the edges of the river edge and in some cases defines the edge of the riverwalk itself in the form of raised planters. See landscaping section for additional information on acceptable plant types.



Edge Condition

Signage

The signage on the Riverwalk serves two purposes: informational and educational. The signage is intended to be minimal so as not to distract from the visitor's experience.

- The city guidelines for signage should be adhered to, any lit signs that are backlit or provide glare are discouraged.



Discreet Signage

Special Elements

Several special elements have been designed and located throughout the project. This includes the spiral overlook at Buffalo Street, several transition circles, and the pavilion at Chicago Street. Each of these elements is constructed of steel framing and aluminum grating. All steel is painted with the same high performance paint system outlined in the Handrail section.



Spiral Overlook at Buffalo

Lighting

The lighting strategy has been developed as a combination of ambient, low glare "moon lighting" and accent lighting that highlights the walkway structure. In addition hidden light sources are projected into the water reflecting indirectly on the dockwall surfaces wherever a gap exists. The overall low glare lighting effect is intended to maximize experience of the cityscape's reflection on the Milwaukee River creating a magical experience for the visitor.

The "Moonlighting" effect is achieved by mounting flood light fixtures to the river face of the building (or pole where no building is available). Fixtures typically are mounted at or near the fifth floor level of the building. The source of the lighting is a 50watt, metal halide lamp. High Pressure Sodium (HPS) lamp sources are not acceptable. Light levels on the walk way should be approximately 0.50 (one half) footcandles.

Additional lighting that competes with the Riverwalk lighting (both Moonlighting and accent lighting) is not acceptable. Proposed building lighting fixtures shall compliment the overall nature of the Riverwalk. This includes fixtures for lighting patios, balconies and other outdoors spaces. Pole (street) lights shall not be used to light any private property or portion of the Riverwalk. Additional lighting shall be configured to avoid glare by using cut-off shield, louvers or other similar devices. Accent lighting sources should utilize either quartz or incandescent lamps.



Night Lighting

Landscaping

A carefully selected group of native plants were identified to soften the riverwalk edge. New planting beds on private property adjacent to the riverwalk should contribute to and be compatible with the overall aesthetic experience.

- Other types of plant species than those selected for the project, in permanent planters or in the ground, are discouraged adjacent to the riverwalk.
- Small-scaled annual plantings in planters to add color on private property is acceptable.

Plant List

Deciduous Trees

- Ohio Buckeye
- Red Maple
- Sugar Maple
- Autumn Purple White Ash
- Quaking Aspen
- Basswood

Ornamental Trees

- Allegheny Serviceberry
- Cockspur Hawthorn

Evergreen Trees

- Eastern Red Cedar
- Eastern White Pine

Deciduous Shrubs

- Running Serviceberry
- Hazelnut
- Redosier Dogwood
- Isanti Redosier Dogwood
- Dwarf-bush Honeysuckle
- Gro-low Fragrant Sumac
- Staghorn Sumac
- American Elderberry
- Dwarf Artic Willow
- Arrowwood Viburnum
- Nannyberry Viburnum

Evergreen Shrubs

- Bar Harbor Juniper

Perennials

- Little Bluestem
- Planter Meadow Mix

Note: Text edited from original document prepared by Engberg Anderson Design Partnership.

Photo Credits

* All photos are by James Piwoni, AIA unless otherwise noted below.

Page 2	Italian Community Center Photo Collection	
Page 24	Historic Third Ward Association Photo Collection	
Page 30	Jen Fletcher	middle, bottom left
Page 30	Jen Fletcher	bottom left, middle five
Page 31	Phillip Miller	bottom right
Page 34	Phillip Miller	bottom left
Page 35	Phillip Kurz	left, bottom right
Page 36	Jeremy Whitener	
Page 37	Jen Stauber	top middle, right
Page 40	Jen Fletcher	bottom right
Page 41	Jen Fletcher	left
Page 47	Historic Third Ward Association Photo Collection	top right
Page 84	Jen Stauber	
Page 85	Jen Stauber	
Page 86	Jeremy Whitener	top middle
Page 93	Department of City Development	

Certified Copy of Ordinance 041316

City of Milwaukee

Office of the City Clerk

**200 E. Wells Street
Milwaukee, Wisconsin 53202**

Certified Copy of Ordinance

FILE NO: 041316

A substitute ordinance relating to the architectural review board.

The Mayor and Common Council of the City of Milwaukee do ordain as follows:

Part 1. Section 308-71 of the code is renumbered 200-61.

Part 2. Section 200-61 of the code is repealed and recreated to read:

200-61. Architectural Review Board.

1. **PURPOSE AND FINDINGS.** The common council finds that the physical and architectural character of certain neighborhoods and locations in the city requires special regulation with respect to the alteration, rehabilitation and construction of buildings, structures or sites because of significant historical, cultural, social or commercial attributes. In order to promote this goal, an architectural review board is created to review all applications for the alteration, rehabilitation or construction of any building, structure or site in a designated district, except for those exempted under sub. 10, prior to the issuance of permits under s. 200-24 by the department of city development.

2. **DEFINITIONS.** In this section:

- a. "Alteration" means any material change in the exterior appearance of any building, structure or site in the district.
- b. "Board" means the architectural review board.
- c. "Certificate of appropriateness" means a certificate issued by the board approving the alteration, rehabilitation or construction of any building, structure or site in the district.
- d. "Design guidelines" means guidelines adopted by the common council for the alteration, rehabilitation or construction of any building, structure or site in the district.
- e. "District" means the area designated by common council resolution 870501 as business improvement district #2. This area shall also be known as the "Historic Third Ward District." "District" also means such additional areas as may be designated by the common council. Each district created hereunder shall have a separate board.
- f. "Rehabilitation" means the improvement of property through repair or alteration.
- g. "Structure" shall include, but is not limited to, a temporary or permanent sign or advertisement placed or erected on the exterior of any building, structure, site or in the public way in the district.

3. COMPOSITION. a. The board shall be composed of 7 members. The members shall consist of one member of the historic preservation commission appointed by its chair; the commissioner of the department of neighborhood services or the commissioner's designee; one member of the common council representing the district under sub. 2-e appointed by the president of the common council, and 4 citizen members appointed by the mayor and confirmed by the common council. A majority of the citizen members shall own or occupy property in the district. Citizen members and the historic preservation commission member shall be appointed for terms of 3 years or until their successors are appointed and confirmed. Members may be reappointed to succeeding terms.

a-1. The mayor, common council president and chair of the historic preservation commission shall make their appointments within 60 days after commencement of a new common council term or within 60 days after the expiration of a member's term or a vacancy in such board position occurs, whichever is later.

a-2. The common council board member may designate an alternate in writing by filing with the city clerk's office. The alternate may represent the common council member and exercise all powers of the member when such member is unable to attend board meetings.

b. With respect to any board for any district created after the effective date of this section, February 18, 2005, 2 of the initial citizen members shall be appointed for one year; one for 2 years and one for 3 years.

c. Citizen members shall be exempt from city service provisions.

d. Citizen members may be removed for cause by the mayor.

e. Board members shall receive no compensation.

f. No member of the board shall vote on any matter that materially affects the property, income, or business interest of that member or creates the appearance of a conflict of interest.

4. FUNCTIONS, POWERS AND DUTIES. The board shall:

a. Adopt by-laws, rules and procedures concerning the operation of the board.

b. Designate one of its citizen members, or retain the services of a consultant, as its administrative officer to perform administrative functions pursuant to the direction of the board and to draft decisions, findings and orders for consideration by the board.

c. Utilize the design guidelines when reviewing applications for certificates of appropriateness for the alteration, rehabilitation and construction of buildings, structures and sites in the district.

d. Issue certificates of appropriateness with or without conditions for the alteration, rehabilitation or construction of any building, structure or site in the district.

e. Advise and assist property owners and other persons and groups, regarding the design guidelines, programs and regulations concerning the district.

f. Work closely with the department of neighborhood services to provide training and technical assistance on issues relating to the design, preservation, repair, renovation and maintenance of buildings, structures and sites in the district.

g. Make recommendations to the common council regarding amendments to the design guidelines and the designation of additional areas for inclusion in the district.

5. CERTIFICATE OF APPROPRIATENESS. No person or entity shall, with respect to the exterior of any building, structure or site in the district, alter, rehabilitate, or reconstruct all or any part of, undertake any new construction with respect to, or permit any work to be performed upon a building, structure or site, nor shall the commissioner of city development issue a permit for any such work unless a certificate of appropriateness has been issued by the board, as

provided in this subsection.

a. Application. Applications for a certificate of appropriateness shall be obtained from and filed with the district office which address shall be on file in the city clerk's office.

b. Review. b-1. Upon receipt of an application for a certificate of appropriateness for the alteration, rehabilitation or construction of any building, structure or site in the district, the board shall review it at its next regular meeting, provided the application is complete and is received before the board's published deadline for the receipt of applications.

b-2. The board may designate one or more persons to administratively approve applications for certificates of appropriateness that comply with the design guidelines without board review, provided that the board shall first adopt a written policy on the types of projects which may be administratively approved.

b-3. Except as provided in subd. 2, the board shall review the proposed alteration, rehabilitation or construction project to determine if it complies with the design guidelines. If the proposed project complies with the design guidelines, the board shall find the proposed project appropriate and issue a certificate of appropriateness. If the board finds that the proposed project does not comply with the guidelines, the board shall deny the application and provide written notice of this denial to the applicant within 30 days of such denial.

b-4. In the event that the board denies an application for a certificate of appropriateness pursuant to subd. 3, the applicant may request a public hearing before the board by submitting a written request to the district office within 30 days of the date of denial.

c. Public Hearing. c-1. Upon receipt of a written request for a public hearing on the board's denial of an application for a certificate of appropriateness, the board shall schedule the hearing within 45 days of receipt of the request.

c-2. Notice of the public hearing shall be sent by certified mail, return receipt requested, addressed to the applicant's address as stated in the application. Notice shall also be posted by the city clerk, sent to the common council member representing the district and sent, via first class mail, to all recorded owners of property within 500 feet of the building, structure or site in the district that is the subject of the public hearing. Notice shall be provided not less than 10 days prior to the date of the public hearing.

c-3. The notice of public hearing may require the applicant to provide supplemental information, including, but not limited to, photographs, plans, floor plans, elevations or detailed drawings of any building, structure, site or portion thereof.

c-4. The board may grant adjournments for any reason upon good cause.

c-5. At the public hearing the applicant shall be entitled to call witnesses and present evidence in support of the application for the certificate of appropriateness. The board shall take testimony from and consider the evidence of any person in attendance at the hearing. An audiotape record shall be made of all proceedings at the public hearing. Such audiotapes shall be made available to any person upon payment of the reasonable costs to process and reproduce such tapes.

c-6. After all evidence has been received, the board shall review the record to determine whether, notwithstanding non-compliance with the design guidelines, the application for a certificate of appropriateness should be granted. In making this determination the board shall consider:

c-6-a. Whether the proposed work would alter or affect any significant architectural feature of the building, structure or site upon which the work is to be done.

c-6-b. Whether the proposed alteration, rehabilitation or construction would harmonize with the character and appearance of neighboring buildings, structures or sites within the district.

c-6-c. Whether the proposed alteration, rehabilitation or construction would be consistent with

an approved comprehensive land use plan for the district.

c-6-d. The existence of extraordinary circumstances under which strict adherence to the design guidelines would cause a substantial hardship on the applicant provided, however, that such hardship is not self-imposed or based solely on economic grounds.

c-7. Following review of the record from the public hearing, the board shall either affirm its denial of the application for a certificate of appropriateness or grant the application. If denial of the application is affirmed, the board shall notify the applicant of its decision by certified mail, return receipt requested, within 30 days of its decision. The board shall set forth the findings of fact that constitute the basis for its decision. All decisions of the board shall be filed with the commissioners of neighborhood services and city development.

d. Appeals. Applicants may appeal to the common council the denial of an application for a certificate of appropriateness following a public hearing. Appeals shall be in the form of a written request filed with the city clerk within 30 days after the mailing of the certified letter containing the board's decision. The city clerk shall file the appeal with the common council. The council shall hold a public hearing on the appeal and shall, by a majority vote of its members, affirm or reverse the decision of the board.

e. Resubmission of Application. Whenever an application for a certificate of appropriateness is denied, the proposed alteration, rehabilitation or construction project is ineligible for reconsideration for a period of one year following the denial.

f. The board shall issue a certificate of appropriateness within 30 days of the board's decision granting such application or within 30 days of a decision of the common council reversing the denial of an application of a certificate of appropriateness by the board after public hearing.

6. OTHER PERMITS AND APPROVALS REQUIRED. The issuance of a certificate of appropriateness shall not relieve the applicant from obtaining other necessary permits and approvals required by the city. All other ordinances, rules and regulations of the city remain applicable.

7. COMPLIANCE WITH CERTIFICATES OF APPROPRIATENESS. a. Within 12 months of the issuance of the certificate of appropriateness, work on the project must begin, shall at all times be in compliance with the certificate and be completed within 24 months of the issuance of the certificate of appropriateness, or the certificate shall be subject to revocation by the board. The board may grant extensions to complete a project upon good cause.

b. Projects approved, started and not completed prior to the effective date of this section, February 18, 2005 shall be granted an extension of 24 months from the effective date of this section (February 18, 2007).

c. Failure to comply with a certificate of appropriateness shall be a violation of this section. In the event work is being performed without, or not in accordance with, a certificate of appropriateness, the board shall request that a stop work order be issued by the commissioner of neighborhood services.

8. PERMIT REVOCATION. Any permit issued by the commissioner of city development under the terms of this section may be revoked by the commissioner of neighborhood services whenever any of the conditions under which the permit was issued are not complied with.

9. EXCEPTIONS. a. The Henry W. Maier Festival grounds, except for the grounds' perimeter fences, are exempt from the provisions of this section.

b. Ordinary routine maintenance and repair of buildings, structures or sites may be undertaken without a certificate of appropriateness, provided that the work involves routine maintenance or repair of existing features of a building or structure or the replacement of elements of a building or structure with pieces identical in appearance and provided that the work does not change the exterior appearance and does not require the issuance of a building permit.

10. VIOLATIONS. a. Whenever the commissioner of neighborhood services determines that a violation of this section exists or has reasonable grounds to believe that such a violation exists, the commissioner is authorized to order the owner to correct the violation or issue a stop work order, if requested, as provided in sub. 7-c.

b. Any person violating any provision of this section shall be subject to the penalties under s. 200-19.



I, Ronald D. Leonhardt, City Clerk, do hereby certify that the foregoing is a true and correct copy of a(n) Ordinance passed by the COMMON COUNCIL of the City of Milwaukee, Wisconsin on February 1, 2005, published on February 17, 2005, effective February 18, 2005.

Ronald D. Leonhardt

Ronald D. Leonhardt
City Clerk

February 10, 2005

Date Certified