



CERTIFICATE OF APPROPRIATENESS APPLICATION FORM

Incomplete applications will not be processed for Commission review.
Please print legibly.

1. HISTORIC NAME OF PROPERTY OR HISTORIC DISTRICT: (if known)
Green Gate (W. Sawyer House) / Northpoint South Hist. District

ADDRESS OF PROPERTY:
2221 N. Terrace Ave, Milw., WI 53202

2. NAME AND ADDRESS OF OWNER:
Name(s): ANDREW NUNEMAKER

Address: 2221 N. Terrace Ave.

City: Milw. State: WI ZIP 53202

Email: andy.nunemaker@intermedix.com

Telephone number (area code & number) Daytime: 424-424-7391 Evening: same

3. APPLICANT, AGENT OR CONTRACTOR: (if different from owner)
Name(s): Living Space Design-Build Co., Inc.

Address: 9055 N. 51st St., Suite J

City: Milw. State: WI ZIP Code: 53223

Email: jim@living spacedesign-build.com

Telephone number (area code & number) Daytime: 414-975-7773 Evening: 414-975-7773

4. ATTACHMENTS

A. REQUIRED FOR ALL PROJECTS:

Photographs of affected areas & all sides of the building (annotated photos recommended)

Sketches and Elevation Drawings (1 full size and 2 reduced to 11" x 17" or 8 1/2" x 11")

Material and Design Specifications (see next page)

B. NEW CONSTRUCTION/DEMOLITION ALSO REQUIRES: (POOL & FENCE)

Floor Plans (1 full size and 1 reduced to 11" x 17")

Site Plan showing location of project and adjoining structures and fences

Other (explain): POOL SPECS.

PLEASE NOTE: YOUR APPLICATION CANNOT BE PROCESSED UNLESS BOTH PAGES OF THIS FORM ARE PROPERLY COMPLETED.

5. DESCRIPTION OF PROJECT:

Describe all existing features that will be affected by proposed work. Please specify the condition of materials, design, and dimensions of each feature (additional pages may be attached)

FENCE & GATES - Wood fence on the west property line will remain. Existing chain link fence on south property line is dilapidated and will be replaced. The coach house & main house form the north & east boundaries of the pool area. South neighbor's garage forms the south boundary. Pool area is currently clear of all trees, shrubs & structures.

Photo No. #1-8 Drawing No. LivingSpace #1.

B. Describe all proposed work, materials, design, dimensions and construction technique to be employed (additional pages may be attached)

FENCE & GATE - Masonry piers will match existing piers in both brick & mortar. Fences & Gate shall be welded steel sections bolted at piers, matching existing as shown in attached drawings. Fence & gate components to be epoxy painted black to match existing.
POOL, DECK & EQUIPMENT - See Neuman Pool CD's.

Photo No. #1-8 Drawing No. LivingSpace #1, 2 & 3
Neuman Pool # PL1.0, PL1.1 & PL2.0

6. SIGNATURE OF APPLICANT:

Signature
James R. Dorr 1-27-12
Print or type name Date

This form and all supporting documentation **MUST** arrive by 12:00 noon on the deadline date established to be considered at the next Historic Preservation Commission Meeting. Any information not provided to staff in advance of the meeting will not be considered by the Commission during their deliberation. Please call if you have any questions and staff will assist you.

Hand Deliver or Mail Form to:
Historic Preservation Commission
City Clerk's Office
200 E. Wells St. Room B-4
Milwaukee, WI

PHONE: (414) 286-5722

FAX: (414) 286-3004

www.milwaukee.gov/hpc



Pool hidden
by house &
trees

Pool ends here

Detail A: Existing View of future Pool Gate – Main, from Terrace Avenue



Existing wood fence

space between
neighbor's garage
and coach house

space between
coach house and
main house

Detail B: Existing View of future Side Gate and Fence from yard



New gate
will copy
some of
the details
of the existing
gate.

Detail C: Existing Main Gate – Close-Up



Main House Elevation(east) - from North Terrace Avenue



Main House Elevation(north) - from East Ivanhoe Place



Main House Elevation (west) – From Driveway

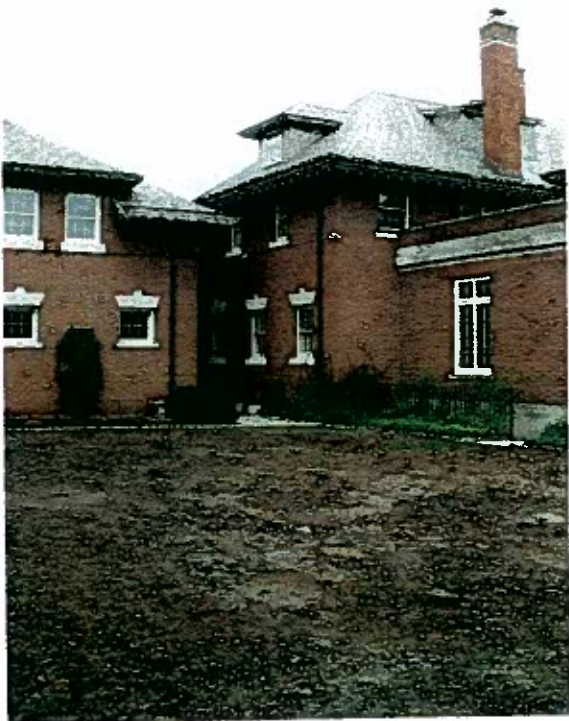

Main House Elevation (west) – from Backyard



Main House Elevation(south) – from backyard



Main House Elevation (south) – continued

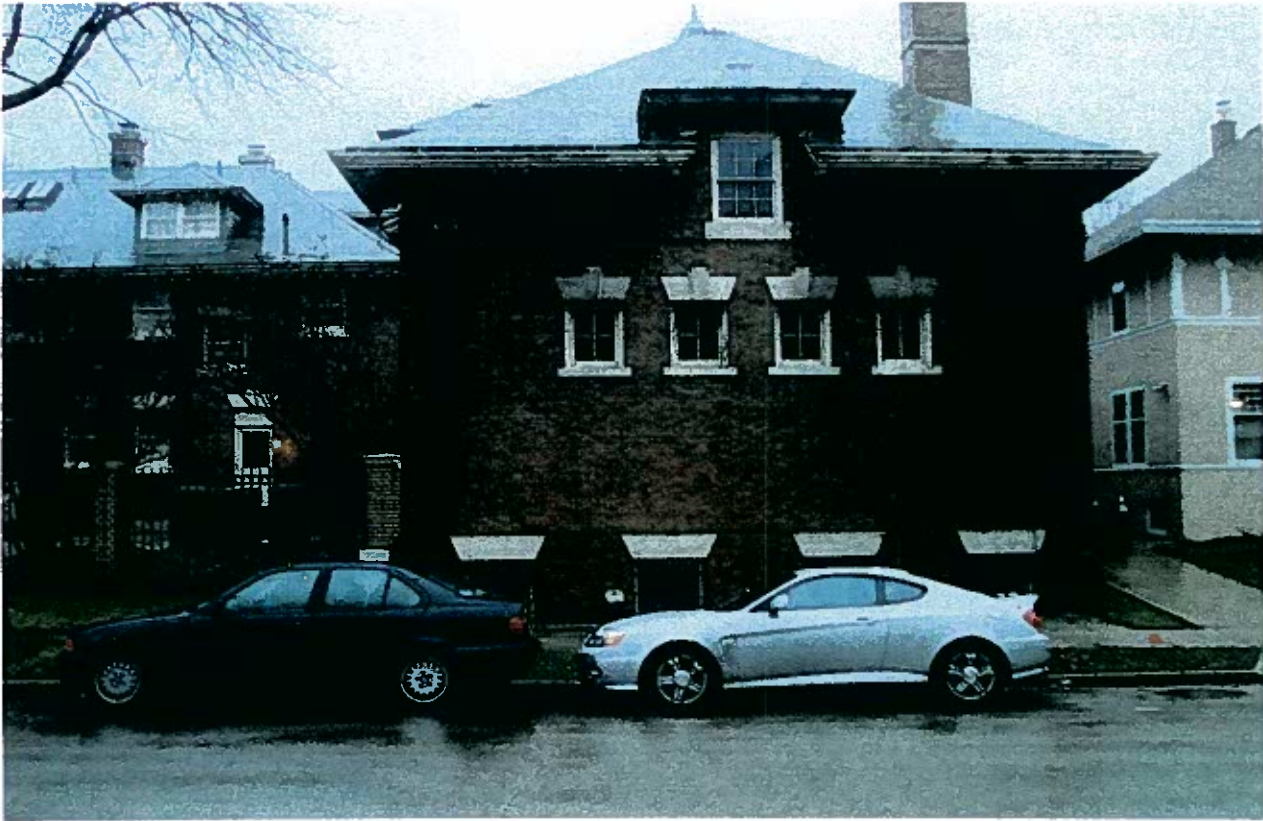

Coach house – From East Ivenhoe Place



Coach house Elevation (west)

New fence between bldgs.

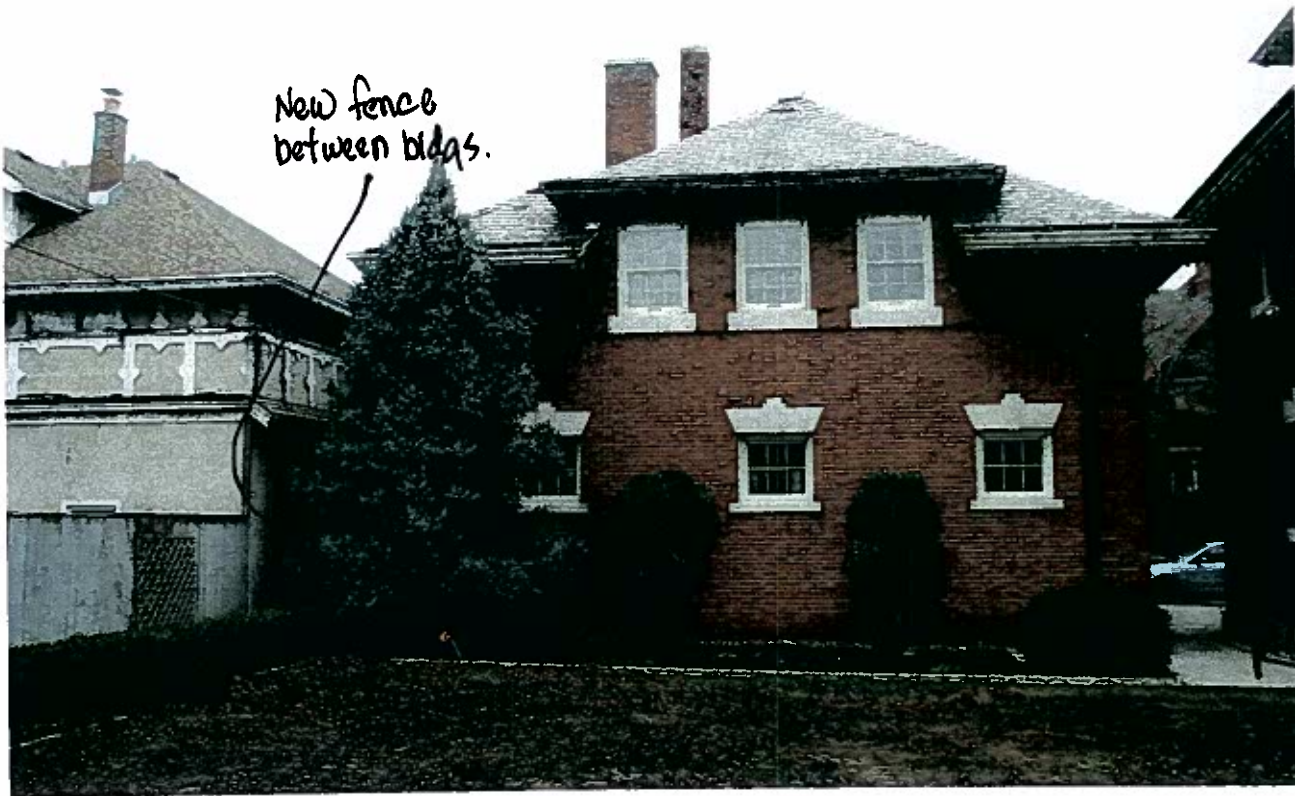

New fence
between bldgs.

New Gate

Coach house Elevation (south)



Coach House Elevation (east)



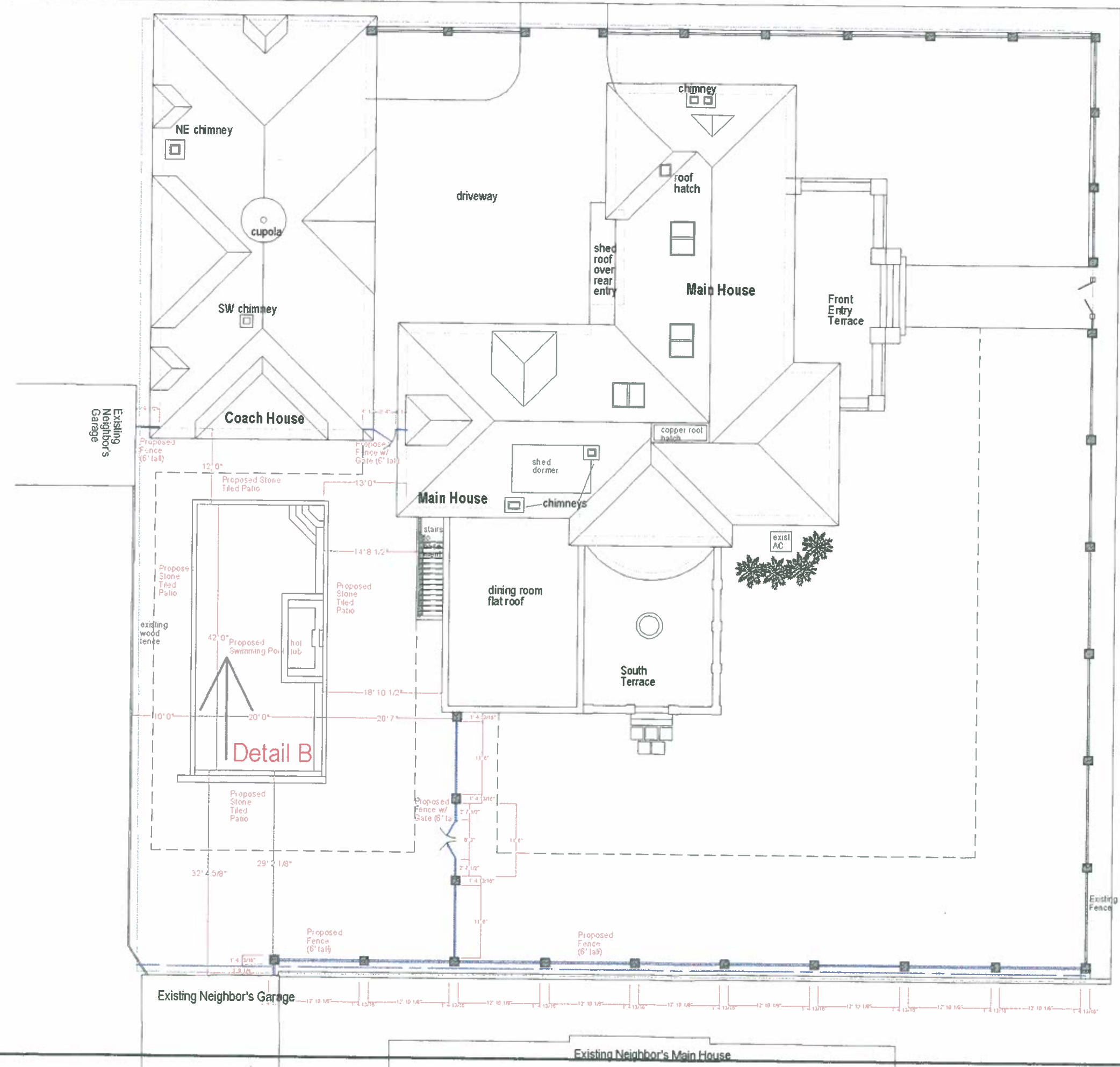

Detail C

Detail A

North Terrace Ave.



North

Neighbor's Garage

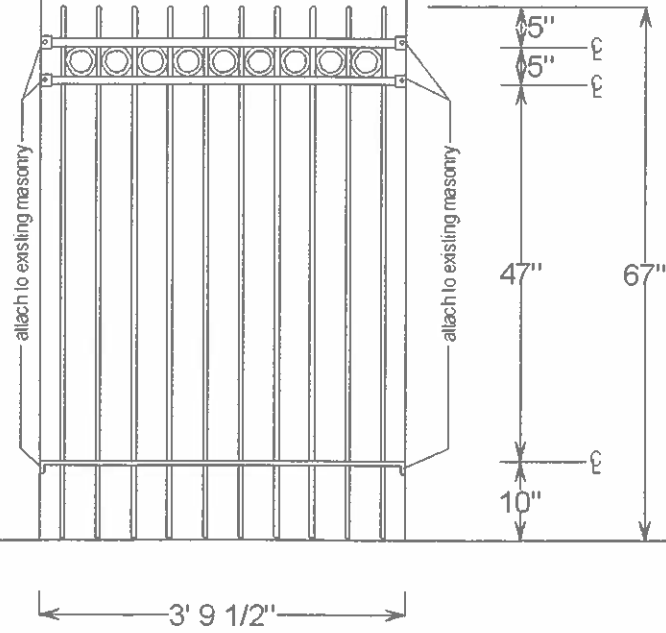

Coach House

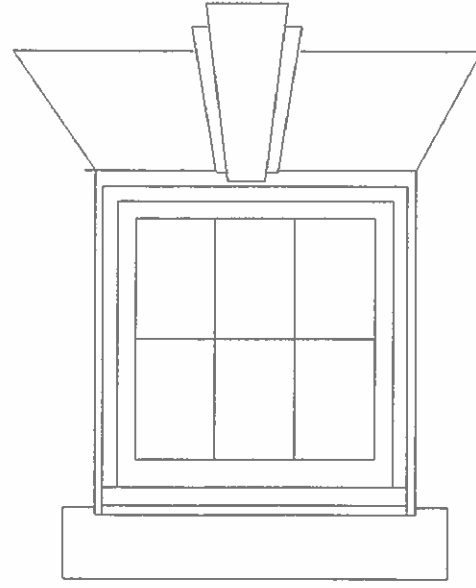

Coach House

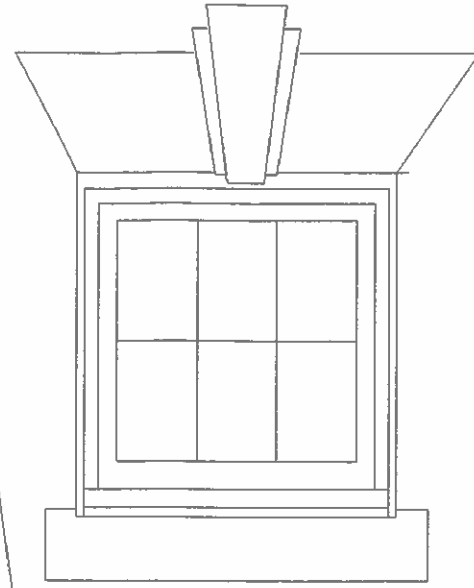

Main House

