

Features

- 190 narrow stile has 2-1/8" (54) vertical stile, 2-1/4" (57.2) top and 3-7/8" (98.4) bottom rail
- 350 medium stile has 3-1/2" (88.9) vertical stile, 3-1/2" (88.9) top and 6-1/2" (165.1) bottom rail
- 500 wide stile has 5" (127) vertical stile, 5" (127) top and 6-1/2" (165.1) bottom rail
- Door is 1-3/4" (44.5) deep
- Dual moment welded corner construction
- Single or double acting
- Infills range from 1/4" (6.4) to 1" (25.4)
- Offset pivots, butt hinges, continuous geared hinge or center pivots
- MS locks or panic hardware
- Surface mounted or concealed closers
- Architects Classic push/pulls
- Adjustable astragal utilizing pile weathering with polymeric fin at meeting stiles
- Polymeric bulb weatherstripping in door frames
- Permanodic™ anodized finishes in seven choices
- Painted finishes in standard and custom choices

Optional Features

- Paneline™ exit device or Paneline™ EL exit device
- Wide variety of bottom rail and cross rail

Product Applications

- 190 narrow stile - engineered for moderate traffic in applications such as offices and stores
- 350 medium stile - provides extra strength for schools, institutions and other high traffic applications
- 500 wide stile - creates a monumental visual statement for banks, libraries or buildings that experience heavy traffic conditions

For specific product applications,
Consult your Kawneer representative.

necessary for product improvement.
 entrance, window, and curtain wall products vary widely. Kawneer does not control
 the selection of product configurations, operating hardware, or glazing materials,
 and assumes no responsibility therefor.

© Kawneer Company, Inc., 2015

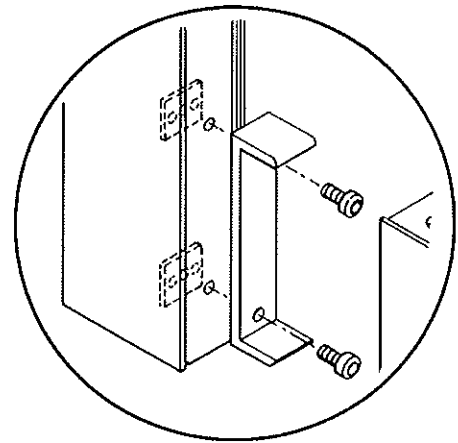
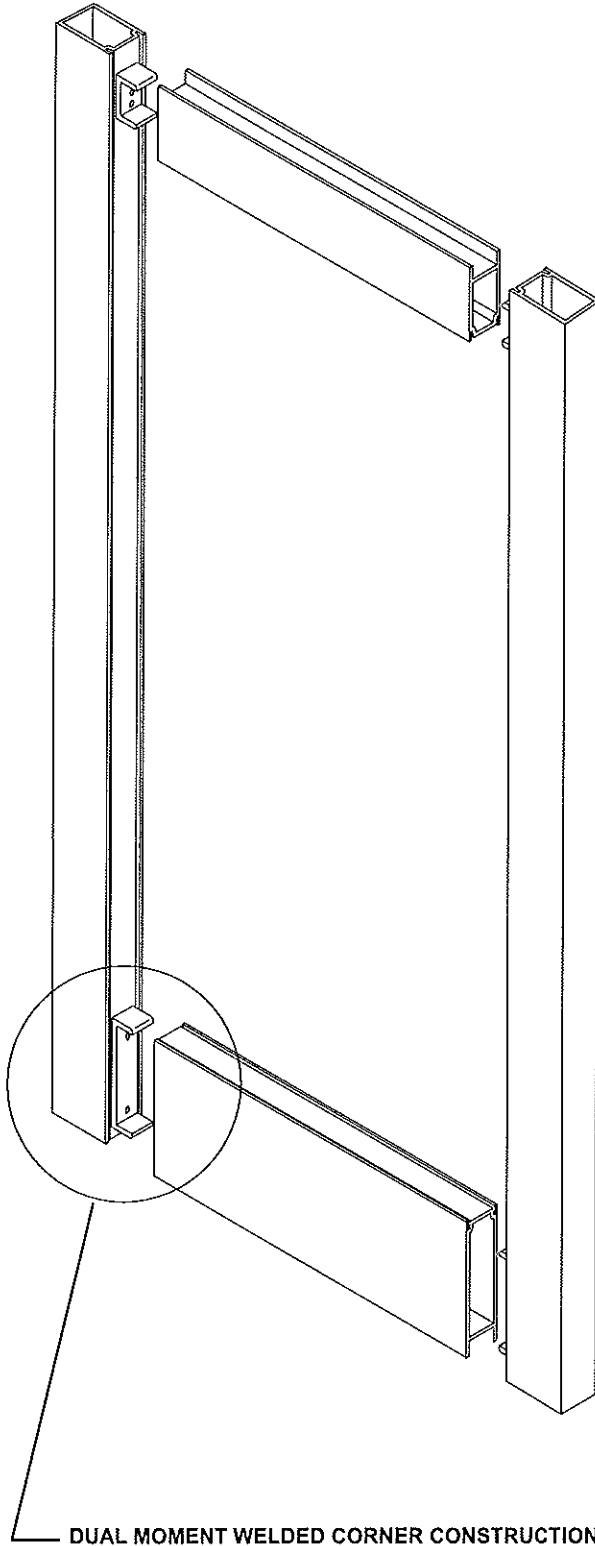

#1 **MECHANICAL FASTENING** is accomplished by attaching a 5/16" (7.9) thick extruded aluminum channel clip to the vertical stile with 1/4"-20 heat strengthened bolts and 3/16" thick steel nut plates for a high strength welding base for attachment horizontal member.

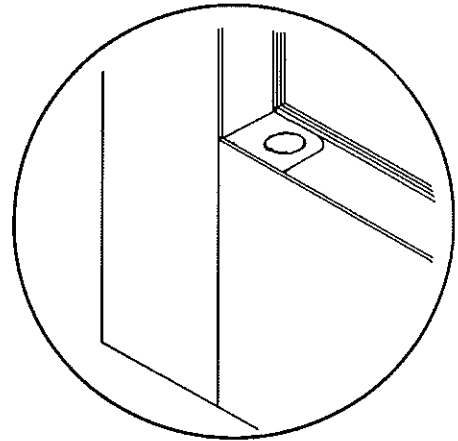

#2 **SIGMA* DEEP PENETRATION PLUG WELDS** are made top and bottom after the horizontal is properly positioned over the channel clip to help provide the strongest door corner joint currently available.

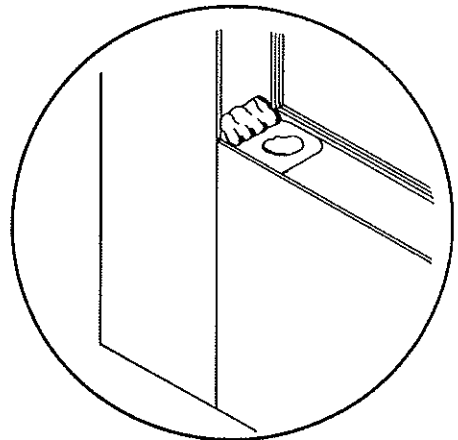

#3 **SIGMA* FILLET WELDS** along both top and bottom webs of the rail extrusion complete the welded corner construction.

* An arc welding process known as Shielded Inert Gas Metal Arc (SIGMA) or also known as Metal Inert Gas (MIG).

SCALE 3" = 1' 0"

190 NARROW STILE

350 MEDIUM STILE

500 WIDE STILE

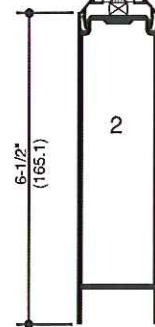
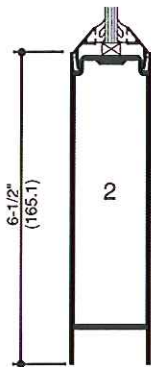
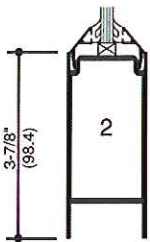
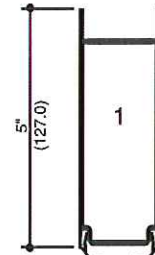
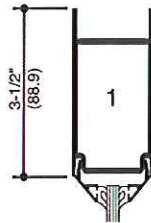
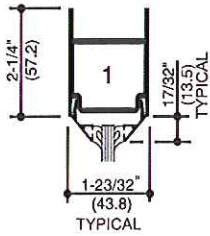
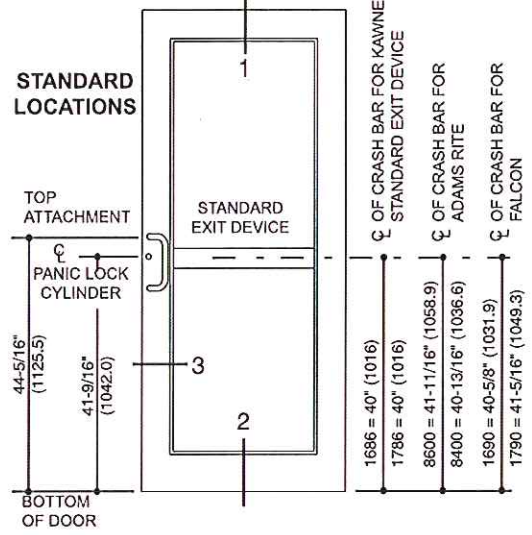
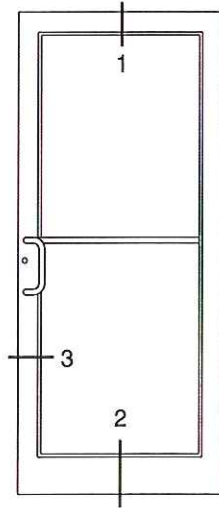
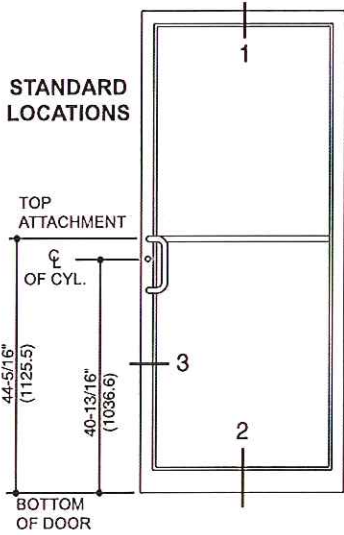

SINGLE ACTING

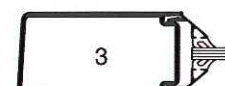

SINGLE ACTING



SINGLE ACTING

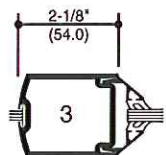

DOUBLE ACTING

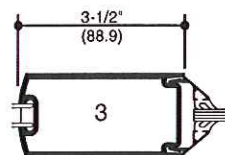

DOUBLE ACTING

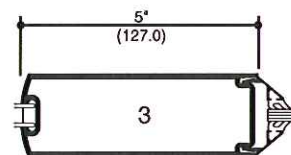

DOUBLE ACTING

Laws and building and safety codes governing the design and use of glazed entrance, window, and curtain wall products vary widely. Kawneer does not control the selection of product configurations, operating hardware, or glazing materials, and assumes no responsibility therefor.

Kawneer reserves the right to change configuration without prior notice when deemed necessary for product improvement.

© Kawneer Company, Inc., 2015

REFER TO HARDWARE SECTION FOR COMPLETE HARDWARE INFORMATION.

ARCHITECTS CLASSIC (PUSH PULL SETS)

SINGLE ACTING DOORS USE A PULL HANDLE AND PUSH BAR AS STANDARD
 DOUBLE ACTING DOORS USE CP PUSH BARS BACK TO BACK AS STANDARD.

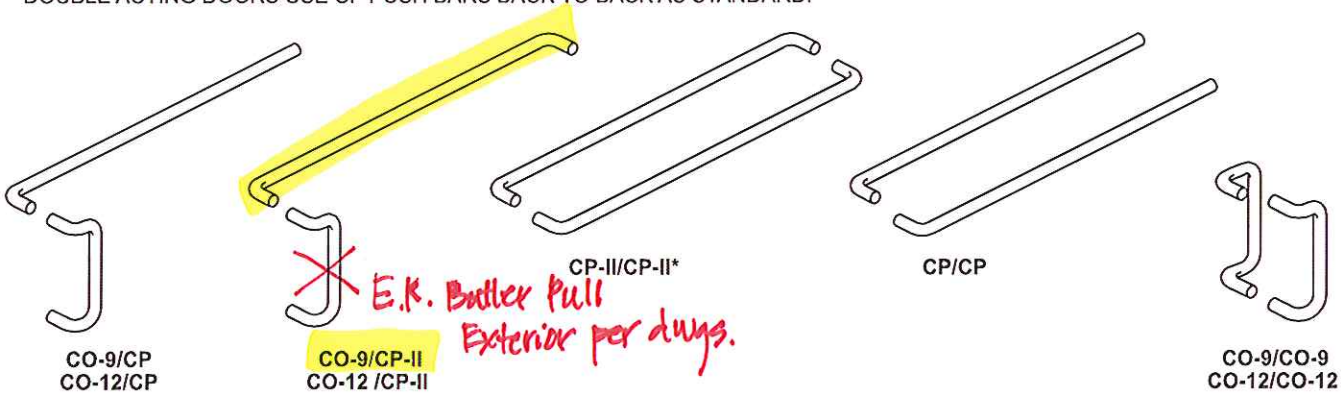

ARCHITECTS CLASSIC (COMPONENTS)

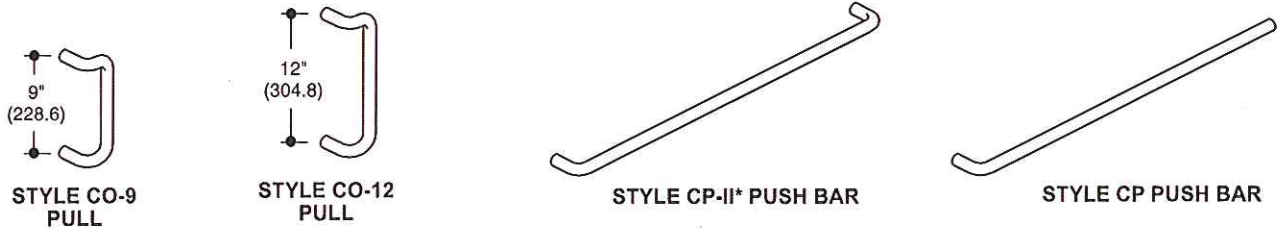

* CP-II PUSH BAR IS NOT TO BE USED FOR BACK TO BACK MOUNTING ON D/A DOORS.

EXIT DEVICES

KAWNEER PANELINE™ / PANELINE™ EL

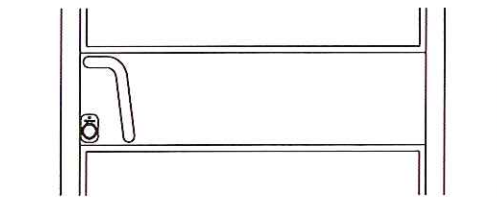
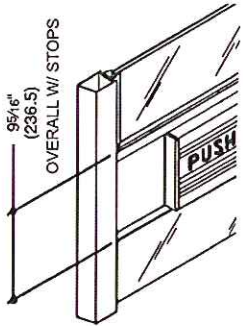

EXTERIOR VIEW OF 190 DOOR (350/500 SIMILAR)
 "CPN" PULL AND OPTIONAL CYLINDER GUARD SHOWN.

SEE PAGE 13 AND 14 FOR COMPLETE
 PANELINE™ INFORMATION

EXIT DEVICES AND PULLS

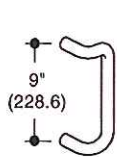

STYLE "CO-9"
 PULL

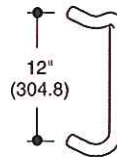

STYLE "CO-12"
 PULL

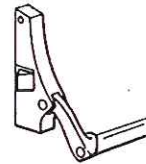

RIM LATCH
 Falcon 2090

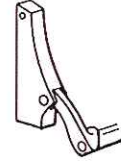

CONCEALED ROD
 Falcon 1990

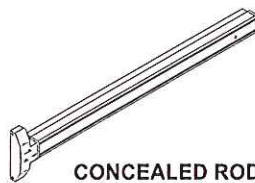

CONCEALED ROD
 Falcon 1690
 Falcon EL 1690

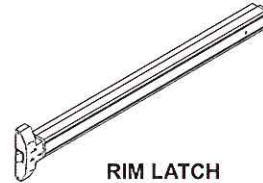

RIM LATCH
 Falcon 1790
 Falcon EL 1790

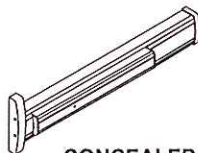

CONCEALED ROD
 Kawneer 1686
 Kawneer 1686 EL
 Kawneer 1686 CD



RIM LATCH
 Kawneer 1786
 Kawneer 1786 EL
 Kawneer 1786 CD

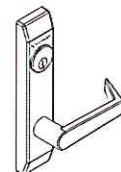

LEVER HANDLE
 Kawneer 1686
 Kawneer 1786

Laws and building and safety codes governing the design and use of glazed entrance, window, and curtain wall products vary widely. Kawneer does not control the selection of product configurations, operating hardware, or glazing materials, and assumes no responsibility therefor.

Kawneer reserves the right to change configuration without prior notice when deemed necessary for product improvement.
 © Kawneer Company, Inc., 2015

SCALE 3" = 1' 0"

HORIZONTAL / VERTICAL CROSS RAILS

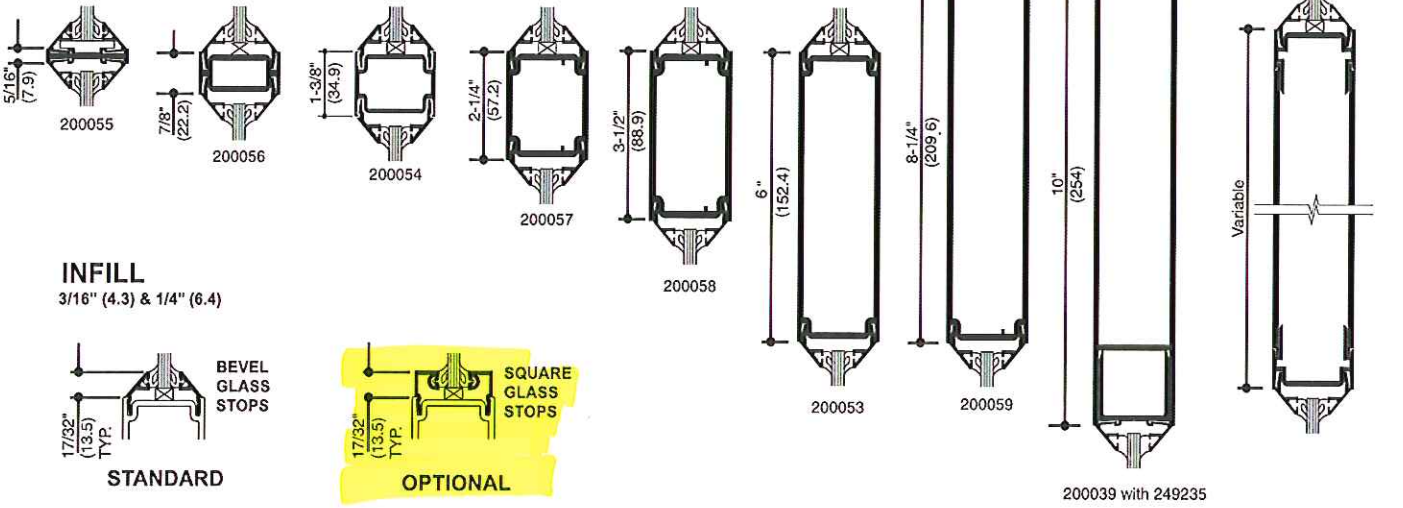

INFILL

3/16" (4.3) & 1/4" (6.4)

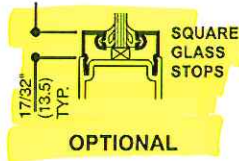
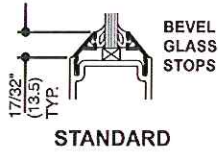

INFILL OPTIONS

5/16" (7.9) & 3/8" (9.5)

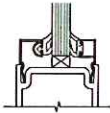

7/16" (11.1) & 1/2" (12.7)

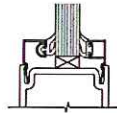

9/16" (14.3) & 5/8" (15.9)

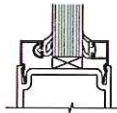

11/16" (17.5) & 3/4" (19.0)

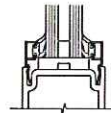

15/16" (23.8) & 1" (25.4)

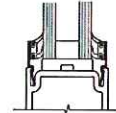

ACCESSORY ITEMS

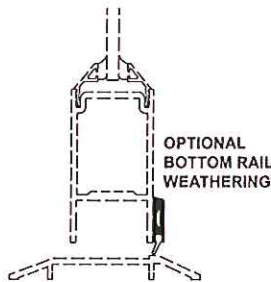
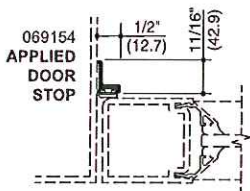
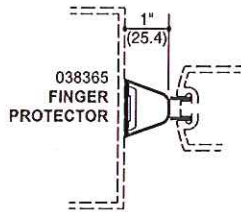
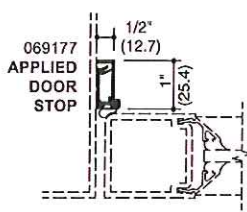

THRESHOLDS

APPLICATION

FOR SINGLE ACTING DOOR

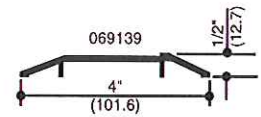

FOR CENTER HUNG CONCEALED CLOSER

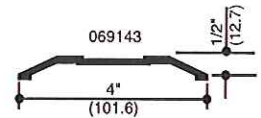

APPLIED STOP FOR SINGLE ACTING DOOR



FOR CENTER HUNG FLOOR CLOSERS

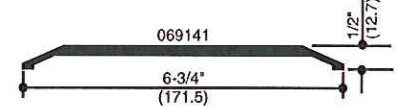

*SOME BUILDING CODES LIMIT THRESHOLD HEIGHT TO 1/2" (12.7) MAX.

entrance, window, and curtain wall products vary widely. Kawneer does not control the selection of product configurations, operating hardware, or glazing materials, and assumes no responsibility therefor.

© Kawneer Company, Inc., 2015