

HardiePlank® Lap Siding Product Description

HardiePlank lap siding is factory-primed fiber-cement lap siding available in a variety of styles and textures. Please see your local James Hardie® product dealer for product availability. HardiePlank® lap siding comes in 12 ft. lengths. Nominal widths from 5¼ in. to 12 in. create a range of exposures from 4 in. to 10¾ in.

HardiePlank lap siding is also available with ColorPlus® Technology as one of James Hardie's prefinished products. ColorPlus Technology is a factory applied, oven-baked finish available on a variety of James Hardie siding and trim products. See your local dealer for details and availability of products, colors and accessories.



Select Cedarmill®



Smooth



Beaded Cedarmill®



Beaded Smooth

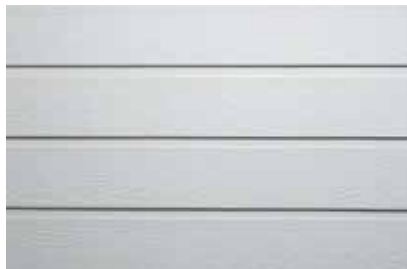

Custom Colonial Roughsawn®



Custom Colonial Smooth®



Installation of HardiePlank® Lap Siding

INSTALL A STARTER STRIP

HardiePlank® lap siding requires a starter strip beneath the first course to set it on the proper angle and to create a proper drip edge at the bottom of the siding. Starter strips are easily made by ripping 1 ¼ in. pieces of HardiePlank siding from full or partial planks.

The bottom of the starter strip should be installed even with the bottom of the mudsill or the bottom edge of the sheathing. The strip must be installed over the water-resistant barrier, but occasional gaps should be left in the starter strip to allow any accumulated moisture behind the siding to drain away safely.

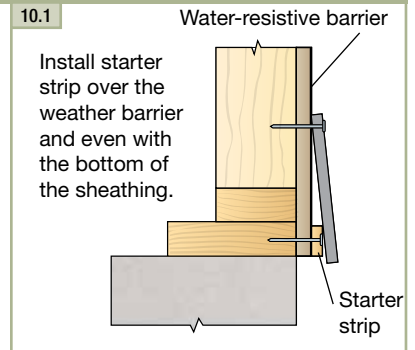

TIP: For accurate fastening, snap vertical chalk lines on the water-resistant barrier at the center of every stud location.

OVERVIEW OF HARDIEPLANK LAP SIDING

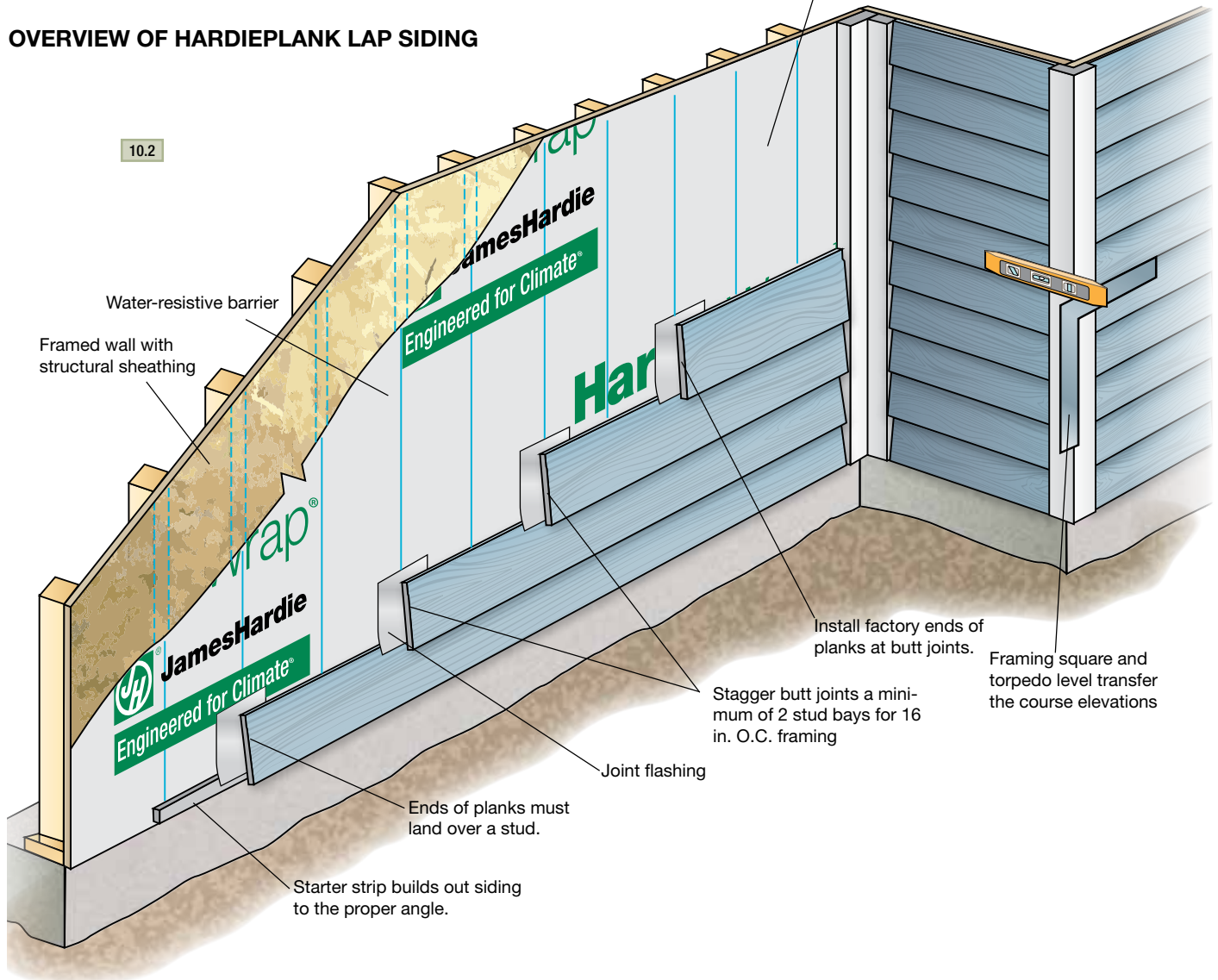

INSTALLING THE PLANKS

The first course of HardiePlank® siding is critical to the proper installation of the plank on the rest of the building. The first course should start at the lowest point of the house and within required clearances. Special attention should be made to ensure that it's straight and level. Attention should also be paid to staggering any butt joints in the planks so that the installation is attractive while making efficient use of material.

1. Use a level (4 ft. or longer) or chalked level line to be sure that the first course is level. As installation proceeds up the wall, periodically check the level and straightness of the courses. When correcting for flatness over products such as exterior insulation, use drywall shims. It is good practice to snap a chalk line every 3 to 5 courses to keep the planks straight and level.
2. Position the bottom edge of the first course of siding a minimum ¼ in. below the edge of the starter strip (maintain required clearances) and secure.
3. Run the siding to the HardieTrim® board leaving a 1/8 in. gap between the siding and trim.

The bottom of the siding should be kept even with the bottom of the trim, or if desired, the trim may extend below the bottom of the siding. But the siding should never hang below the trim. ***When installing the first course make sure ground clearances are in accordance with James Hardie requirements and those of local codes.**

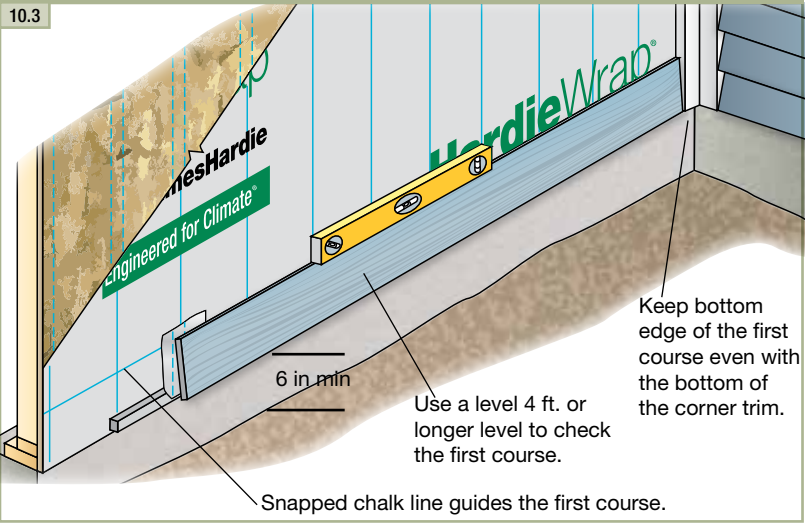

PLANK ALIGNMENT AT CORNERS

For the best looking installation, make sure that the heights of the plank courses match on both sides of a corner. Use a framing square, speed square or a level to match up the plank heights. Check every few courses to make sure proper heights are being maintained.

TIP: When taking planks from the pallet installation, avoid repeating the texture pattern by working across the pallet. Two to four planks can be removed from a stack at one time. But then material should be taken from adjacent stacks, again working across the pallet. Texture repeat is typically a concern on large walls with few breaks such as windows or doors.

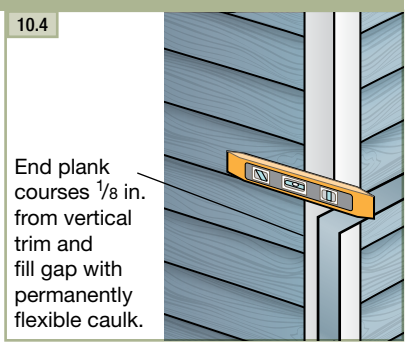

Pull from across the stack

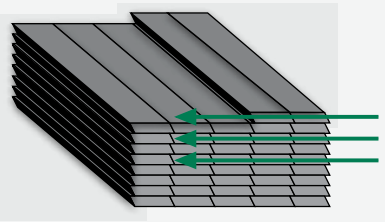

Do not go down the stack

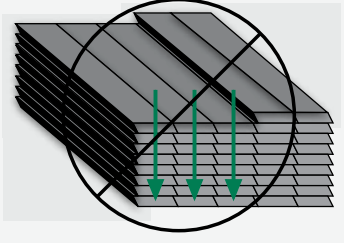

Installation of HardiePlank® Lap Siding (cont.)

BLIND NAILING (nailing through top of plank)

Blind nailing is recommended for installing any type of HardiePlank® lap siding including ColorPlus® siding. With blind nailing, each course covers the fasteners on the course below, which provides a better looking installation.

For blind nailing HardiePlank lap siding, James Hardie recommends driving fasteners 1 in. from the top edge of the plank. Additionally fasteners should be placed no closer than 3/8 in. from the ends of the plank.

10.5 Blind nailing measurements

Nails for blind nailing shall be between 3/4 in and 1 in. from the top of the board.

Keep nails 3/8 in from ends of boards.

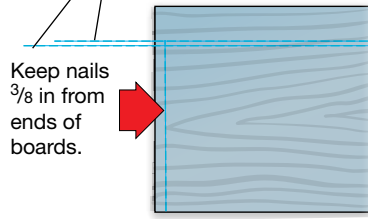

10.6 Blind nailing

Fasteners are hidden by the course above.

Nails are driven through the sheathing into the studs.

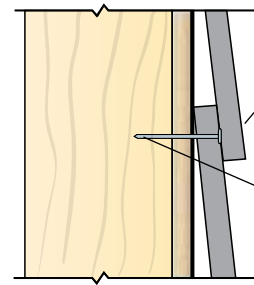

Avoid placing fasteners near the top edge of the plank. This practice, called “high nailing”, may lead to loose planks, unwanted gaps or rattling. **Pin-backed corners may be done for aesthetic purposes only. Finish nails are recommended for pin-backs. Headed siding nails are allowed. Place pin-backs no closer than 1 in. from plank ends and 3/4 in. from plank edge into min. 3/8 in. wood structural panel. Pin-backs are not a substitute for blind or face nailing**

FACE NAILING (nailing through the overlap at the bottom of the plank)

Although blind nailing is recommended by James Hardie, face nailing may be required for certain installations including: installations in high wind areas, fastening into OSB or equivalent sheathing without penetrating a stud, or when dictated by specific building codes. Refer to Appendix D for related code matters.

10.7 Face nailing

Exposed fasteners are driven through the face of the boards.

Drive fasteners only where planks overlap

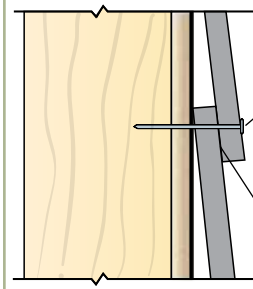

STAGGERING THE BUTT JOINTS

For walls longer than 12 ft, it is necessary to butt joint additional lengths of HardiePlank siding. These butt joints should be staggered to avoid noticeable patterns, which is determined by the placement of the first course. Butt joints between consecutive courses should be spaced apart by at least two stud bays for 16 in., o.c. framing or one bay for 24 in. o.c. framing.

While random placement of the planks is usually the most aesthetically pleasing, a progressive stagger pattern can make the job easier and faster without the pattern becoming too noticeable. With this strategy, the cut off piece for one course becomes the starter piece for a course above, making efficient use of materials and ensuring that all butt joints land on studs. The pattern can be modified for different stud placement.

10.8

Cutoff pieces form the starter pieces for courses above.

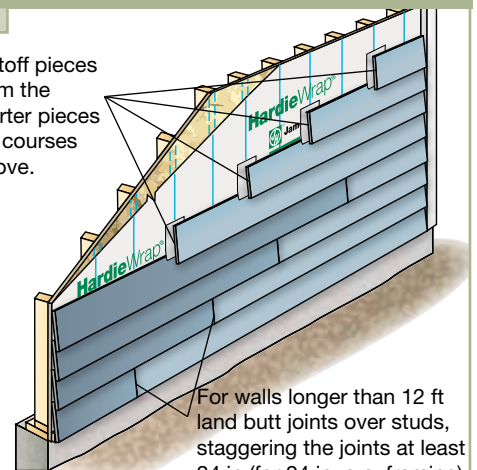

For walls longer than 12 ft land butt joints over studs, staggering the joints at least 24 in. (for 24 in. o.c. framing) or 32 in. (two stud bays for 16 in. o.c. framing).

JOINT FLASHING

One or more of the following joint treatment options are required by code (as referenced 2009 IRC R703.10.2)

- A. Joint Flashing (James Hardie recommended)
- B. Caulking* (Caulking is not recommended for ColorPlus for aesthetic reasons as the Caulking and ColorPlus will weather differently. For the same reason, do not caulk nail heads on ColorPlus products.)
- C. "H" jointer cover

Flashing behind butt joints provides an extra level of protection against the entry of water at the joint. James Hardie recommends 6 in. wide flashing that overlaps the course below by 1 in. Some local building codes may require different size flashing.

Joint-flashing material must be durable, waterproof materials that do not react with cement products. Examples of suitable material include finished coil stock and code compliant water-resistive barriers. Other products may also be suitable.

TIP: Joint flashing can be quickly and easily made by cutting a 6 in. wide section off a roll of housewrap. Tape the roll tightly at the cut mark and cut the section off using a miter saw with a carbide blade. Individual sheets then can be cut to length with a utility knife.

TIP: Use light-colored joint flashing when using light-colored ColorPlus lap siding or other siding with a light-colored finish. Dark-color joint flashings should be used on siding with dark finishes.

10.9 Flashing behind to add an additional layer of protection from water infiltration

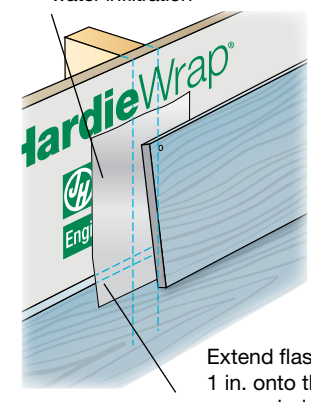

10.10

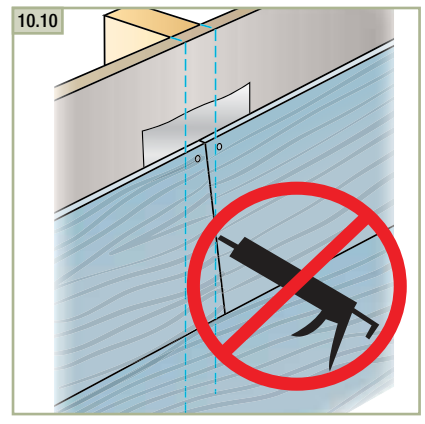

Caulking at HardiePlank lap siding butt joints is not recommended for ColorPlus for aesthetic reasons as the caulking and ColorPlus will weather differently. For the same reason, do not caulk exposed nail heads. Refer to the ColorPlus touch-up section for details

JOINT PLACEMENT AND TREATMENT

Butt joints in HardiePlank lap siding should always land on a stud. Butt joints between studs are not recommended and should be avoided. Whenever possible, factory-finished ends should be used at butt joints.

Place cut ends where the siding meets a corner, door, window trim, or other break in the wall where the joint is to be caulked. If cut ends are used in a butt joint between planks, James Hardie requires sealing cut ends for all products. For ColorPlus products, use the color-matched edge coater to seal the cut end.

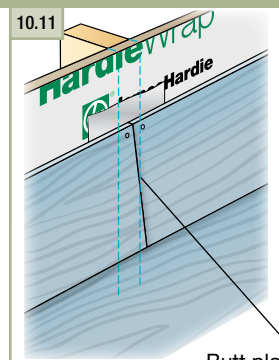

Butt planks with moderate edge contact

COLORPLUS® TIP: When installing HardiePlank lap siding with ColorPlus Technology, position the plank in the immediate area where the plank is to be fastened. Do not place the plank on the course below and slide into position. Doing so may scuff or scratch the ColorPlus finish on the installed piece.

Installation of HardiePlank® Lap Siding (cont.)

CONTINUING THE INSTALLATION

Once the initial course of HardiePlank® siding is fastened to the wall, continue installing successive courses with full 12 ft. pieces (follow the stagger pattern for longer walls), or until a window, door or other opening interrupts the course (fig 10.12). Notch planks as needed to fit around windows and doors. Again, be sure to seal all cut edges. Avoid placing butt joints directly above or below windows or above doors. Separate the joint from the opening by at least one course of siding.

Where butt joints land on a stud, make sure there is enough stud space for plank on both sides of the joint to land properly. Optimally both sides of a butt joint should land in the middle of a stud with $\frac{3}{4}$ in landing space for each side. The minimum stud space for a plank to land is $\frac{3}{8}$ in.

Pay special attention to window, doors, and corners that have been trimmed before the siding goes on. Vertical trim boards may cover the king studs beside windows or doors, or they may cover up corner studs leaving no room for nailing the siding. In these places add extra studs as needed.

If corners are trimmed with **HardieTrim® 5/4, 4/4 boards**, it may be necessary to measure and cut the first pieces of siding to make sure the butt joints land on studs.

10.12 Planking around windows

Add an extra stud if necessary for nailing the ends of the planks.

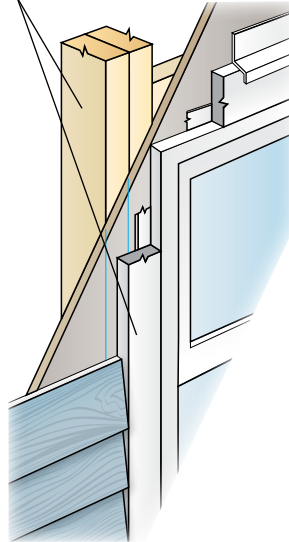

Notch plank around window trim and flashing.

Keep butt joints more than one course away from top of window.

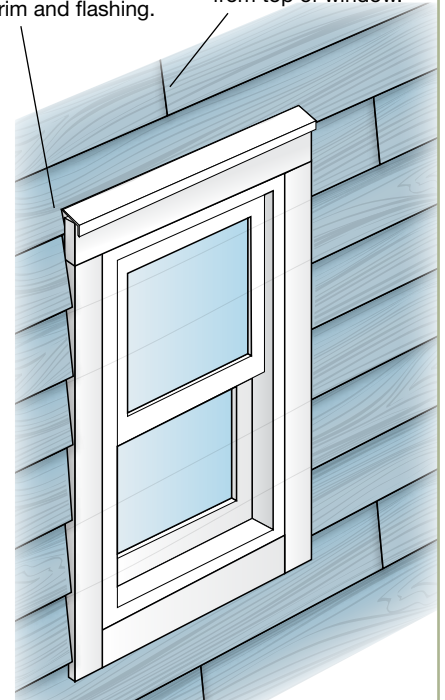

COLORPLUS TIP: HardiePlank lap siding with ColorPlus Technology is shipped with a protective laminate slip sheet, which should be left in place during cutting and fastening to reduce marring and scratching. The sheet should be removed immediately after each plank is installed.



INSTALLING HARDIEPLANK® SIDING ON GABLE WALLS

Siding gable walls can be challenging, and some of the keys to siding gable walls efficiently are determining the angle or pitch of the roof, properly staging materials, and ensuring that the plank lengths are measured accurately.

To estimate the amount of siding needed to complete a gable end, use the estimating tools located in Appendix C.

Stage enough material on the pump jacks or scaffolding to complete the gable end, but take care not to overload the staging. When possible, a cut table should be located on the pump jacks or scaffolding, which frees up crew members to work on other walls.

To cut planks for the gable:

1. Tack up a small scrap piece of siding where the first gable course is going.
2. Hold a second small piece of siding against the eave or rake board.
3. Trace the angle onto the scrap.
4. Cut that line and label the scrap as the template for the gable angle. The template can then be used to transfer the angle onto the larger pieces for cutting and installation.
5. Periodically check the angle as you progress up the wall.

The quickest way to measure and cut consecutive courses of siding for a gable is to work off the previous piece.

1. Cut and fit the lowest course of siding.
2. Before installing, lay it flat and measure down 1 1/4 in. from the top edge of the plank for the course overlap. Make a mark on both ends.
3. Set a piece of uncut siding on top of the first piece, aligning the bottom edge with the overlap marks. Transfer the length directly to the uncut piece.
4. Draw the gable angle with the template, cut the angle and then repeat the process for the next course.

TIP: Stainless steel fasteners are recommended when installing James Hardie® products.

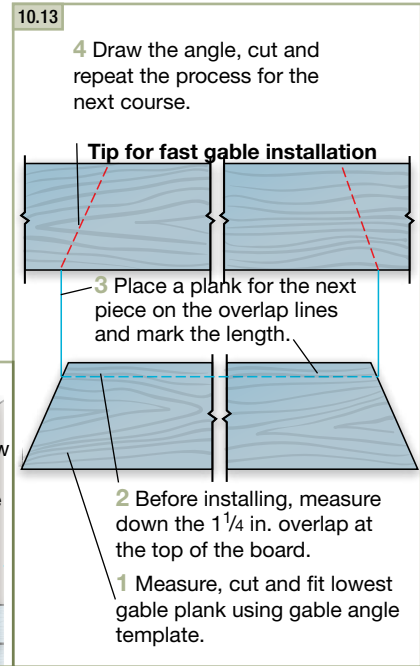
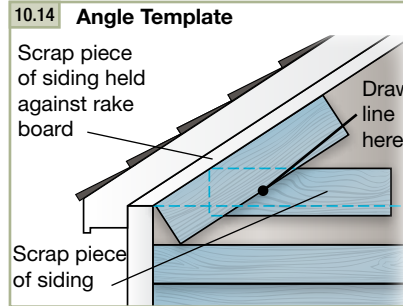

HARDIEPLANK® SIDING FASTENER SPECIFICATIONS

The Fastener Specifications table shows fastener options for a variety of different nailing substrates. Please refer to the applicable ESR report online (see back page) to determine which fastener meets your wind load design criteria.

Fastener Substrate		Approved Fastener	Fastener Type
wood studs	blind nail	16 in o.c.	2 .113 in. x .267 in x 2 in. — 6D common
		24 in o.c.	3, 9, 16 .093 in. x .222 in. x 2 in. 6D siding nail
	face nail	16 in o.c.	2, 5 No 11ga 1.25 in long roofing nail
		24 in o.c.	2, 5 Ribbed Bugle-Head No. 8 .323 in. x 1.625 in screws
steel studs*	blind nail	16 in o.c.	8, 13 Ribbed Wafer-Head No. 8 (.375 in x 1.25 in)
		24 in o.c.	12 [AKN-100] .100 in x .25 in x 1.5 in ET&F
	face nail	16 in o.c.	13 [AGS-100] .100 in x .313 in. x 1.5 in
		24 in o.c.	7, 12, 14 [ASTM C-90] ASM-144-125 (P/C) .30 in x .14 in x 1.25 in masonry nail
Direct to Masonry		14 .113 in. x .260 in x 2.375 in 8D common	
7/16 in OSB or equivalent (face nailed)		4, 16 No 11ga 1.75 in long roofing nail	
			4 .091 in. x .221 in. x 1.5 in 4D siding nail

*When blind fastening 9.5 in or wider product onto steel studs, use screws.

● indicates recommended fasteners



HardiePlank® Lap Siding

EFFECTIVE DECEMBER 2019

IMPORTANT: FAILURE TO FOLLOW JAMES HARDIE WRITTEN INSTALLATION INSTRUCTIONS AND COMPLY WITH APPLICABLE BUILDING CODES MAY VIOLATE LOCAL LAWS, AFFECT BUILDING ENVELOPE PERFORMANCE AND MAY AFFECT WARRANTY COVERAGE. FAILURE TO COMPLY WITH ALL HEALTH AND SAFETY REGULATIONS WHEN CUTTING AND INSTALLING THIS PRODUCT MAY RESULT IN PERSONAL INJURY. BEFORE INSTALLATION, CONFIRM YOU ARE USING THE CORRECT HARDIEZONE® PRODUCT INSTRUCTIONS BY VISITING HARDIEZONE.COM OR CALL 1-866-942-7343 (866-9-HARDIE)

STORAGE & HANDLING:

Store flat and keep dry and covered prior to installation. Installing siding wet or saturated may result in shrinkage at butt joints. Carry planks on edge. Protect edges and corners from breakage. James Hardie is not responsible for damage caused by improper storage and handling of the product.

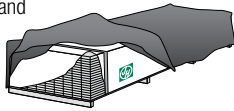

⚠ CUTTING INSTRUCTIONS

OUTDOORS

- Position cutting station so that airflow blows dust away from the user and others near the cutting area.
- Cut using one of the following methods:
 - Best: Circular saw equipped with a HardieBlade® saw blade and attached vacuum dust collection system. Shears (manual, pneumatic or electric) may also be used, not recommended for products thicker than 7/16 in.
 - Better: Circular saw equipped with a dust collection feature (e.g. Roan® saw) and a HardieBlade saw blade.
 - Good: Circular saw equipped with a HardieBlade saw blade.

INDOORS

DO NOT grind or cut with a power saw indoors. Cut using shears (manual, pneumatic or electric) or the score and snap method, not recommended for products thicker than 7/16 in.

- DO NOT dry sweep dust; use wet dust suppression or vacuum to collect dust.
- For maximum dust reduction, James Hardie recommends using the "Best" cutting practices. Always follow the equipment manufacturer's instructions for proper operation.
- For best performance when cutting with a circular saw, James Hardie recommends using HardieBlade® saw blades.
- Go to jameshardiepros.com for additional cutting and dust control recommendations.

IMPORTANT: The Occupational Safety and Health Administration (OSHA) regulates workplace exposure to silica dust. For construction sites, OSHA has deemed that cutting fiber cement with a circular saw having a blade diameter less than 8 inches and connected to a commercially available dust collection system per manufacturer's instructions results in exposures below the OSHA Permissible Exposure Limit (PEL) for respirable crystalline silica, without the need for additional respiratory protection.

If you are unsure about how to comply with OSHA silica dust regulations, consult a qualified industrial hygienist or safety professional, or contact your James Hardie technical sales representative for assistance. James Hardie makes no representation or warranty that adopting a particular cutting practice will assure your compliance with OSHA rules or other applicable laws and safety requirements.

GENERAL REQUIREMENTS:

- HardiePlank® lap siding can be installed over braced wood or steel studs, 20 gauge (33 mils) minimum to 16 gauge (54 mils) maximum, spaced a maximum of 24 in o.c. or directly to minimum 7/16 in thick OSB sheathing. See General Fastening Requirements. Irregularities in framing and sheathing can mirror through the finished application. Correct irregularities before installing siding.
- Information on installing James Hardie products over non-nailable substrates (ex: gypsum, foam, etc.) can be located in JH Tech Bulletin 19 at www.jamehardie.com
- A water-resistive barrier is required in accordance with local building code requirements. The water-resistive barrier must be appropriately installed with penetration and junction flashing in accordance with local building code requirements. James Hardie will assume no responsibility for water infiltration. James Hardie does manufacture HardieWrap® Weather Barrier, a non-woven non-perforated housewrap¹, which complies with building code requirements.
- When installing James Hardie products all clearance details in figs. 3-14 must be followed.
- Adjacent finished grade must slope away from the building in accordance with local building codes - typically a minimum of 6 in. in the first 10 ft.
- Do not use HardiePlank lap siding in Fascia or Trim applications.
- Do not install James Hardie products, such that they may remain in contact with standing water.
- HardiePlank lap siding may be installed on flat vertical wall applications only.
- For larger projects, including commercial and multi-family projects, where the span of the wall is significant in length, the designer and/or architect should take into consideration the coefficient of thermal expansion and moisture movement of the product in their design. These values can be found in the Technical Bulletin "Expansion Characteristics of James Hardie® Siding Products" at www.jameshardie.com.
- James Hardie Building Products provides installation/wind load information for buildings with a maximum mean roof height of 85 feet. For information on installations above 60 feet, please contact JH technical support.

INSTALLATION: JOINT TREATMENT

One or more of the following joint treatment options are required by code (as referenced 2009 IRC R703.10.2)

- Joint Flashing (James Hardie recommended)
- Caulking* (Caulking is not recommended for ColorPlus for aesthetic reasons as the Caulking and ColorPlus will weather differently. For the same reason, do not caulk nail heads on ColorPlus products.)
- "H" jointer cover

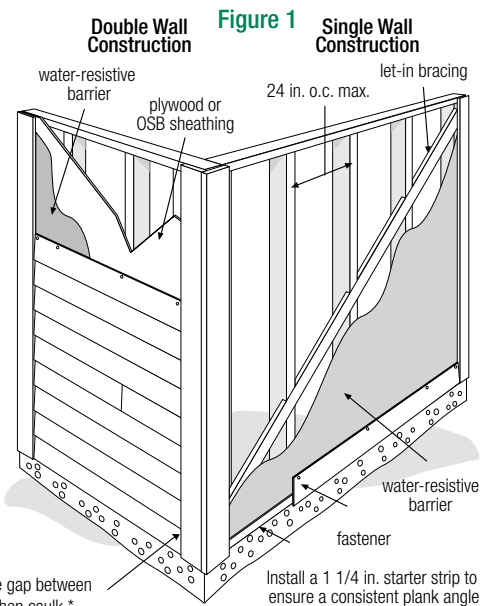
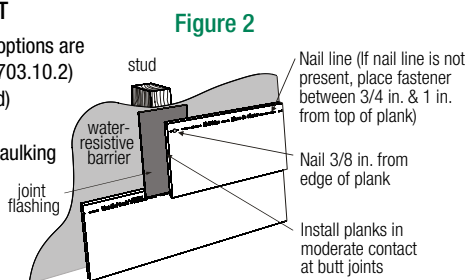

Note: Field painting over caulking may produce a sheen difference when compared to the field painted PrimePlus. *Refer to Caulking section in these instructions.

¹For additional information on HardieWrap® Weather Barrier, consult James Hardie at 1-866-4Hardie or www.hardiewrap.com



SELECT CEDARMILL® | SMOOTH | BEADED CEDARMILL® | BEADED SMOOTH | CUSTOM COLONIAL™ SMOOTH | CUSTOM COLONIAL™ ROUGHSAWN



Visit jameshardiepros.com for the most recent version.

HS11119 P1/4 12/19

CLEARANCE AND FLASHING REQUIREMENTS

Figure 3
Roof to Wall

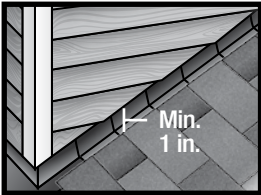

Figure 4
Horizontal Flashing

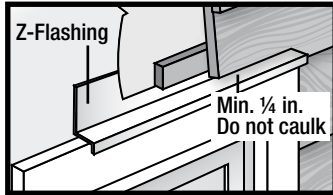

Figure 5
Kickout Flashing

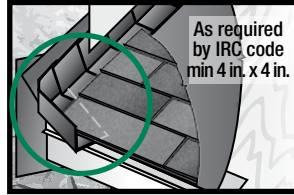

Figure 6
Slabs, Path, Steps to Siding

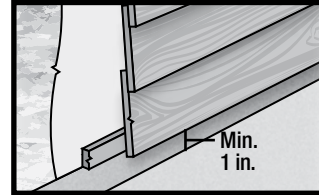

Figure 7
Deck to Wall

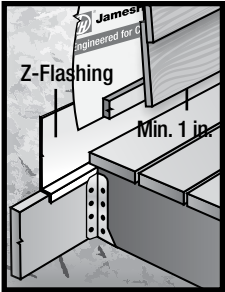

Figure 8
Ground to Siding

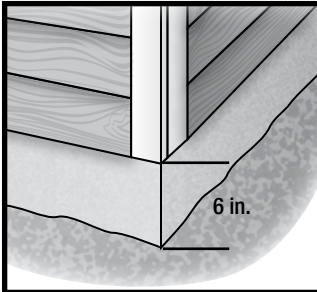

Figure 9
Gutter to Siding

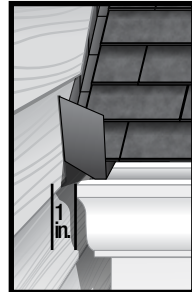

Figure 10
Sheltered Areas

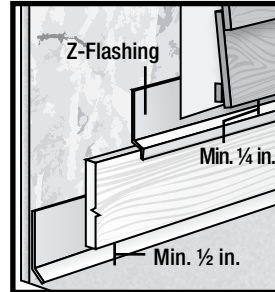

Figure 11
Mortar/Masonry

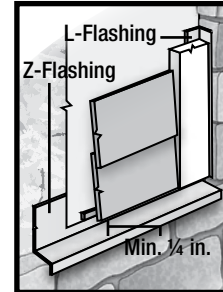

Figure 12
Drip Edge

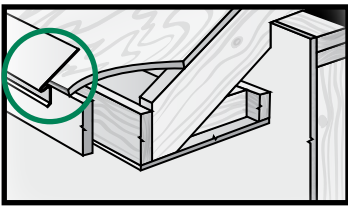

Figure 13
Block Penetration
(Recommended in HZ10)

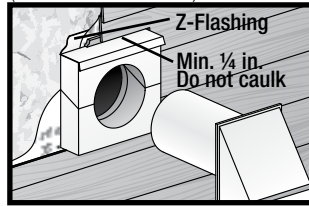
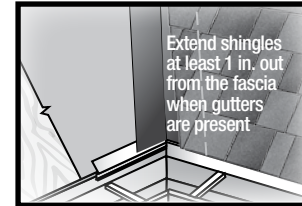

Figure 14
Valley/Shingle Extension



FASTENER REQUIREMENTS*

Refer to the applicable ESR report online to determine which fastener meets your wind load design criteria.

Blind Nailing is the preferred method of installation for HardiePlank® lap siding products. Face nailing should only be used where required by code for high wind areas and must not be used in conjunction with Blind nailing (Please see JH Tech bulletin 17 for exemption when doing a repair).

BLIND NAILING

Nails - Wood Framing

- Siding nail (0.09 in. shank x 0.221 in. HD x 2 in. long)
- 11ga. roofing nail (0.121 in. shank x 0.371 in. HD x 1.25 in. long)

Screws - Steel Framing

- Ribbed Wafer-head or equivalent (No. 8 x 1 1/4 in. long x 0.375 in. HD) Screws must penetrate 3 threads into metal framing.

Nails - Steel Framing

- ET & F Panelfast® nails or equivalent (0.10 in. shank x 0.313 in. HD x 1-1/2 in. long) Nails must penetrate minimum 1/4 in. into metal framing.

OSB minimum 7/16 in.

- Siding nail (0.09 in. shank x 0.215 in. HD x 1-1/2 in. long)
- Ribbed Wafer-head or equivalent (No. 8 x 1 5/8 in. long x 0.375 in. HD).

FACE NAILING

Nails - Wood Framing

- 6d (0.113 in. shank x 0.267 in. HD x 2 in. long)
- Siding nail (0.09" shank x 0.221" HD x 2" long)

Screws - Steel Framing

- Ribbed Bugle-head or equivalent (No. 8-18 x 1-5/8 in. long x 0.323 in. HD) Screws must penetrate 3 threads into metal framing.

Nails - Steel Framing

- ET & F pin or equivalent (0.10 in. shank x 0.25 in. HD x 1-1/2 in. long) Nails must penetrate minimum 1/4 in. into metal framing.

OSB minimum 7/16 in.

- Siding nail (0.09 in. shank x 0.221 in. HD x 1-1/2 in. long)

*Also see General Fastening Requirements; and when considering alternative fastening options refer to James Hardie's Technical Bulletin USTB 5 - Fastening Tips for HardiePlank Lap Siding.

FASTENER REQUIREMENTS continued

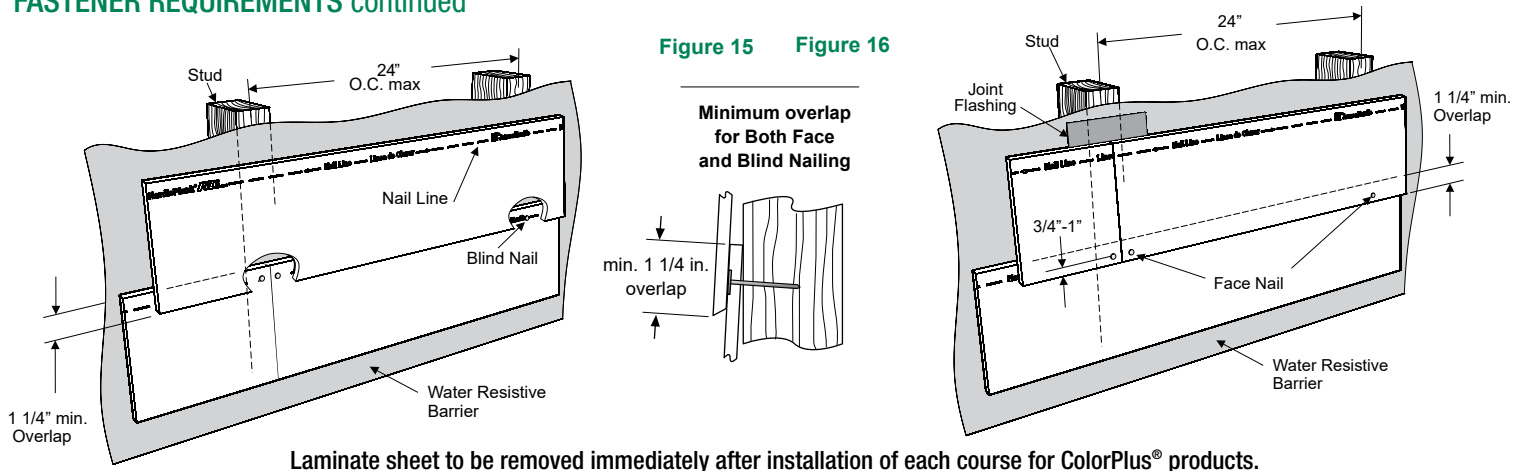

Laminate sheet to be removed immediately after installation of each course for ColorPlus® products.

Pin-backed corners may be done for aesthetic purposes only. Finish nails are recommended for pin-backs. Headed siding nails are allowed. Place pin-backs no closer than 1 in. from plank ends and 3/4 in. from plank edge into min. 3/8 in. wood structural panel. Pin-backs are not a substitute for blind or face nailing.

GENERAL FASTENING REQUIREMENTS

Fasteners must be corrosion resistant, galvanized, or stainless steel. Electro-galvanized are acceptable but may exhibit premature corrosion. James Hardie recommends the use of quality, hot-dipped galvanized nails. James Hardie is not responsible for the corrosion resistance of fasteners. Stainless steel fasteners are recommended when installing James Hardie® products near the ocean, large bodies of water, or in very humid climates.

Manufacturers of ACQ and CA preservative-treated wood recommend spacer materials or other physical barriers to prevent direct contact of ACQ or CA preservative-treated wood and aluminum products. Fasteners used to attach HardieTrim Tabs to preservative-treated wood shall be of hot dipped zinc-coated galvanized steel or stainless steel and in accordance to 2009 IRC R317.3 or 2009 IBC 2304.9.5

- Consult applicable product evaluation or listing for correct fasteners type and placement to achieve specified design wind loads.
- NOTE: Published wind loads may not be applicable to all areas where Local Building Codes have specific jurisdiction. Consult James Hardie Technical Services if you are unsure of applicable compliance documentation.
- Drive fasteners perpendicular to siding and framing.
- Fastener heads should fit snug against siding (no air space).
- NOTE: Whenever a structural member is present, HardiePlank should be fastened with even spacing to the structural member. The tables allowing direct to OSB or plywood should only be used when traditional framing is not available.

CUT EDGE TREATMENT

Caulk, paint or prime all field cut edges. James Hardie touch-up kits are required to touch-up ColorPlus products.

CAULKING

For best results use an Elastomeric Joint Sealant complying with ASTM C920 Grade NS, Class 25 or higher or a Latex Joint Sealant complying with ASTM C834. Caulking/Sealant must be applied in accordance with the caulking/sealant manufacturer's written instructions.

Note: some caulking manufacturers do not allow "tooling".

PAINTING

DO NOT use stain, oil/alkyd base paint, or powder coating on James Hardie® Products. Factory-primed James Hardie products must be painted within 180 days of installation. 100% acrylic topcoats are recommended. Do not paint when wet. For application rates refer to paint manufacturers specifications. Back-rolling is recommended if the siding is sprayed.

PNEUMATIC FASTENING

James Hardie products can be hand nailed or fastened with a pneumatic tool. Pneumatic fastening is highly recommended. Set air pressure so that the fastener is driven snug with the surface of the siding. A flush mount attachment on the pneumatic tool is recommended. This will help control the depth the nail is driven. If setting the nail depth proves difficult, choose a setting that under drives the nail. (Drive under driven nails snug with a smooth faced hammer - Does not apply for installation to steel framing).

<p>DO NOT</p> <p>UNDER DRIVE</p>	<p>DO NOT</p> <p>OVER DRIVE</p>	<p>DO NOT USE</p> <p>SLANT</p>
<p>IF, THEN</p>		<p>IF, THEN ADDITIONAL NAIL</p>
<p>WOOD FRAME</p> <p>HAMMER FLUSH</p>	<p>STEEL FRAME</p> <p>REMOVE & REPLACE</p>	<p>FACE NAIL</p> <p>COUNTERSINK & FILL</p>
		<p>ALUMINUM FASTENERS</p>
		<p>CLIPPED HEAD NAILS</p>
		<p>STAPLES</p>



COLORPLUS® TECHNOLOGY CAULKING, TOUCH-UP & LAMINATE

- Care should be taken when handling and cutting James Hardie® ColorPlus® products. During installation use a wet soft cloth or soft brush to gently wipe off any residue or construction dust left on the product, then rinse with a garden hose.
- Touch up nicks, scrapes and nail heads using the ColorPlus® Technology touch-up applicator. Touch-up should be used sparingly. If large areas require touch-up, replace the damaged area with new HardiePlank® lap siding with ColorPlus® Technology.
- Laminate sheet must be removed immediately after installation of each course.
- Terminate non-factory cut edges into trim where possible, and caulk. Color matched caulks are available from your ColorPlus® product dealer.
- Treat all other non-factory cut edges using the ColorPlus Technology edge coat, available from your ColorPlus product dealer.

Note: James Hardie does not warrant the usage of third party touch-up or paints used as touch-up on James Hardie ColorPlus products.

Problems with appearance or performance arising from use of third party touch-up paints or paints used as touch-up that are not James Hardie touch-up will not be covered under the James Hardie ColorPlus Limited Finish Warranty.

PAINTING JAMES HARDIE® SIDING AND TRIM PRODUCTS WITH COLORPLUS® TECHNOLOGY

When repainting ColorPlus products, James Hardie recommends the following regarding surface preparation and topcoat application:

- Ensure the surface is clean, dry, and free of any dust, dirt, or mildew
- Repriming is normally not necessary
- 100% acrylic topcoats are recommended
- DO NOT use stain, oil/alkyd base paint, or powder coating on James Hardie® Products.
- Apply finish coat in accordance with paint manufacturers written instructions regarding coverage, application methods, and application temperature
- DO NOT caulk nail heads when using ColorPlus products, refer to the ColorPlus touch-up section

COVERAGE CHART/ESTIMATING GUIDE

Number of 12 ft. planks, does not include waste

COVERAGE AREA LESS OPENINGS SQ (1 SQ = 100 sq.ft.)	(exposure)	HARDIEPLANK® LAP SIDING WIDTH									
		5 1/4 4	6 1/4 5	7 1/4 6	7 1/2 6 1/4	8 6 3/4	8 1/4 7	9 1/4 8	9 1/2 8 1/4	12 10 3/4	
1		25	20	17	16	15	14	13	13	9	
2		50	40	33	32	30	29	25	25	19	
3		75	60	50	48	44	43	38	38	28	
4		100	80	67	64	59	57	50	50	37	
5		125	100	83	80	74	71	63	63	47	
6		150	120	100	96	89	86	75	75	56	
7		175	140	117	112	104	100	88	88	65	
8		200	160	133	128	119	114	100	100	74	
9		225	180	150	144	133	129	113	113	84	
10		250	200	167	160	148	143	125	125	93	
11		275	220	183	176	163	157	138	138	102	
12		300	240	200	192	178	171	150	150	112	
13		325	260	217	208	193	186	163	163	121	
14		350	280	233	224	207	200	175	175	130	
15		375	300	250	240	222	214	188	188	140	
16		400	320	267	256	237	229	200	200	149	
17		425	340	283	272	252	243	213	213	158	
18		450	360	300	288	267	257	225	225	167	
19		475	380	317	304	281	271	238	238	177	
20		500	400	333	320	296	286	250	250	186	

This coverage chart is meant as a guide. Actual usage is subject to variables such as building design. James Hardie does not assume responsibility for over or under ordering of product.

HS11119 P4/4 12/19

SILICA WARNING
DANGER: May cause cancer if dust from product is inhaled. Causes damage to lungs and respiratory system through prolonged or repeated inhalation of dust from product. Refer to the current product Safety Data Sheet before use. The hazard associated with fiber cement arises from crystalline silica present in the dust generated by activities such as cutting, machining, drilling, routing, sawing, crushing, or otherwise abrading fiber cement, and when cleaning up, disposing of or moving the dust. When doing any of these activities in a manner that generates dust you must (1) comply with the OSHA standard for silica dust and/or other applicable law, (2) follow James Hardie cutting instructions to reduce or limit the release of dust; (3) warn others in the area to avoid breathing the dust; (4) when using mechanical saw or high speed cutting tools, work outdoors and use dust collection equipment; and (5) if no other dust controls are available, wear a dust mask or respirator that meets NIOSH requirements (e.g. N-95 dust mask). During clean-up, use a well maintained vacuum and filter appropriate for capturing fine (respirable) dust or use wet clean-up methods - never dry sweep.

WARNING: This product can expose you to chemicals including respirable crystalline silica, which is known to the State of California to cause cancer. For more information go to P65Warnings.ca.gov.

RECOGNITION: In accordance with ICC-ES Evaluation Report ESR-2290, HardiePlank® lap siding is recognized as a suitable alternate to that specified in the 2006, 2009, 2012 & 2015 International Residential Code for One and Two-Family Dwellings, and the 2006, 2009, 2012 & 2015 International Building Code. HardiePlank lap siding is also recognized for application in the following: City of Los Angeles Research Report No. 24862, State of Florida Product Approval FL#13192, Miami-Dade County Florida NOA No. 17-0406.06, U.S. Dept. of HUD Materials Release 1263f, Texas Department of Insurance Product Evaluation EC-23, City of New York MEA 223-93-M, and California DSA PA-019. These documents should also be consulted for additional information concerning the suitability of this product for specific applications.