



Fully Adhered, Ballasted and Mechanically Attached

January 2026

Part I-General

1.01 Description 3
1.02 General Design Considerations 4
1.03 Quality Assurance 5
1.04 Submittals 6
1.05 Warranty 7

Warranty Tables

TABLE I – Non-Reinforced EPDM Membrane Thickness for Various Warranty Options 8
TABLE II – Reinforced EPDM Membrane Thickness for Various Warranty Options 9
TABLE III – Mechanically Fastened Roofing Systems Fastening Criteria Up to 20 YR Warranty 22 GA. Steel, Structural Concrete, Wood Plank, and 3/4” Plywood Decks 10
TABLE IV – Mechanically Fastened Roofing Systems – Up to 20 YR Warranty – Wood (Plywood or OSB) Decks 11
TABLE V- Re-Roofing Substrate Criteria – Up to 20 YR Warranty 11
TABLE VI –Adhered Roofing Systems – Underlayment Fastening Criteria – Up to 20 YR Warranty 12
TABLE VII- Underlayment/Insulation & Required Attachment Assemblies – Up to 20 Year Warranty for QA EPDM 14
1.06 Job Conditions 15
1.07 Product Delivery, Storage and Handling 16

Part II – Product

2.01 General 17
2.02 Membrane 17
2.03 Insulation/Underlayments 21
2.04 Related Materials 27
2.05 Fastening Components 28
2.06 Insulation Securement Adhesive 30
2.07 Vapor/Air Barrier 31
2.08 Edges and Terminations 31
2.09 Roof Walkways 33
2.10 Other Versico Accessories 33

Part III – Execution – Fully Adhered, Ballasted and Mechanically Attached

3.01 General 34
3.02 Roof Deck/Substrate Criteria 34
3.03 Insulation/Underlayments 36
3.04 Insulation Attachment 37
3.05 Membrane Placement and Securement 39
3.06 Flashing 49
3.07 Roof Walkways 50
3.08 Daily Seal 50
3.09 Optional Color Coating 50
3.10 Clean Up 50

ATTACHMENTS

“Attachment I” – Ballast Criteria and Walkways – Design “B” Ballasted 51
“Attachment II” – 25/30 Year Warranty Design Enhancements 55
Installation Details 65

Note: In addition to information listed in this section Specifiers and Authorized Contractors should reference Spec Supplement and Design Reference Sections for other pertinent information.



This page intentionally blank



VersiGard® EPDM Roofing Systems Fully Adhered, Ballasted and Mechanically Attached

January 2026

The information contained in this generic specification represents a part of Versico's requirements for obtaining a roofing systems warranty. Construction materials and practices, building siting and operations, climatic conditions, and other site-specific factors will have an impact on the performance of the roofing system. Versico recommends that the building owner retain a design professional to determine appropriate design measures to be taken in order to address these factors.

This section is to serve as criteria for Specifiers and Authorized Contractors regarding the design and installation of Versico's Design "A" Fully Adhered, Design "B" Ballasted and Mechanically Attached EPDM Membrane Roofing Systems. Additional information essential for the design and installation of the roof system mentioned herein are also included in the Design Reference Section and also listed in the form of a Specification Supplement at the end of the Technical Manual. Specifiers and Authorized Contractors are advised to reference all applicable sections.

Various Warranty Tables have been included in Paragraph 1.05 citing various requirements by which specific warranty coverage can be obtained. Appropriate Warranty Table should be referenced to ensure proper warranty coverage.

PART I – GENERAL

1.01 Description

- A. **The Design "A" Fully Adhered Roofing System** incorporates **VersiGard (black on white) 60- or 90-mil thick non-reinforced EPDM or VersiGard Gray 60-mil thick non-reinforced or VersiGard WHITE (white) 60-mil thick reinforced or VersiGard Black 45-,60- or 75-mil reinforced EPDM** membrane. An acceptable insulation is mechanically attached to the roof deck or Fully Adhered with Versico supplied urethane-based insulation adhesive or hot asphalt and the EPDM membrane is Fully Adhered to the insulation with Versico's EPDM Bonding Adhesive (Versico's G200SA Substrate Adhesive, Low-VOC Bonding Adhesive, CAV-GRIP 3V or Versico Water Based Adhesive). Adjoining sheets of EPDM membrane are spliced together using 3" or 6" wide QA Seam Tape and Primer or factory-applied QA Seam Tape (VersiGard QAT) and Primer. There are no maximum slope restrictions for the application of this roofing system.

Note: When non-reinforced EPDM membrane is used, Versico recommends a minimum of 60-mil thick material. VersiGard 45-mil non-reinforced EPDM may be utilized when specified or required by the owner or owner's representative.

Water based adhesive may be used for projects with 20-year maximum warranty and wind speed coverage up to 72 mph.

- B. **The Design "B" Loose Laid Ballasted Roofing System** incorporates minimum 45-mil thick VersiGard Black **non-reinforced** or minimum 60-mil **reinforced** EPDM membrane. Both the EPDM membrane and an acceptable membrane underlayment or insulation are loose laid over the substrate and held in place with a minimum of 10 pounds of ballast per square foot depending upon wind load requirements. Adjoining sheets of EPDM membrane are spliced together using 3" or 6" wide QA Seam Tape and Primer or factory-applied QA Seam Tape (VersiGard QAT) and Primer. The maximum roof slope for this roofing system is 2" to one horizontal foot.
- C. **The Mechanically Attached Roofing System** incorporates 45-, 60- or 75-mil VersiGard Black **reinforced** EPDM membrane or **VersiGard WHITE (white) 60-mil thick reinforced** EPDM membrane. An acceptable insulation is Mechanically Attached to the roof deck and, depending on project criteria; the reinforced membrane is Mechanically Attached with the appropriate Versico Fastener and 2" or 2-3/8" diameter Fastening Plates (Polymer Seam Plates required over steel deck) or Fastening Bars at 6" minimum to 12" maximum along the center of the membrane splice.

Adjoining sheets of EPDM membrane are spliced together using 6" Factory-Applied QA Seam Tape (VersiGard QAT) and Primer or QA Seam Tape and Primer. Field membrane sheets are either 5', 6.5', 8' or 10' wide depending upon wind load requirements, building height and type of roof deck. At the roof perimeter, a heavier fastening density is required utilizing 5', 6.5' wide sheets or 9" wide Quick-Applied RTS (Reinforced Termination Strip). The maximum roof slope for this roofing system is 18' in one horizontal foot.

The roofing system can also be specified over an existing standing seam, flat seam or corrugated metal roof with the membrane secured to the structural purlins. Refer to the Metal Retrofit System Specifications and Details.

NOTE: The selection of various components (i.e. insulation, underlayment, membrane thickness, etc.) may vary depending on desired warranty coverage. Refer to appropriate Warranty Tables listed in Paragraph 1.05.

Assemblies with membrane fasteners 12” or longer must be submitted for Versico’s review to ensure adequate securement due to the possibility of increased dynamic fastener movement. Such assemblies when accepted may require the use of additional insulation fasteners and the use of 1/2” SecurShield HD Recover Board.

1.02 General Design Considerations

- A. Projects where wind speed coverage greater than 55 mph is specified or those with a 20-year or longer Total System Warranty will require additional enhancements beyond those outlined in this section. Prior to installation, refer to Warranty Tables in Paragraph 1.05.
- B. Petroleum based products; certain chemicals and waste products (i.e., grease, oil, animal fats, etc.) are not compatible with these roofing systems. Versico should be contacted for verification or compatibility and recommendations concerning an acceptable roofing assembly.
- C. It is the responsibility of the Specifier to review local, state and regional codes to determine their impact on the specified Versico Roofing System.
- D. It is the responsibility of the building owner or his/her designated representative to verify structural load limitation. In addition, a core cut may be taken to verify weight of existing components when the roofing system is to be specified on an existing facility.
- E. Coordination between various trades is essential to avoid unnecessary rooftop traffic over completed sections of the roof and to prevent subsequent damage to the membrane roofing system.
- F. Concentrated loads from rooftop equipment may cause deformation of insulation/underlayment and possible damage to the membrane if proper protection is not provided. A protection course or sleepers must be specified.
- G. Drainage
 - 1. Drainage must be evaluated by the Specifier in accordance with all applicable codes. Slope may be provided by tapering the structure or through the use of tapered insulation; a sufficient number of roof drains should also be specified and properly located to allow for positive drainage. Significant ponding that could remain after 48 hours should be eliminated with the addition of auxiliary drains in low areas where ponding is anticipated.

Versico specifically disclaims responsibility for the design and selection of an adequate drainage system and drain accessories. Selection must be made by the building owner or the owner’s design professional.

- 2. Small incidental areas of ponded water will not impact the performance of this roofing system; however, in accordance with industry standards, the roofing assembly **should be designed to prevent ponding** of water on the roof for prolonged periods (longer than 48 hours). Good roofing practice dictates proper drainage to prevent possible excessive live loads and, in the event of a roof leak, to minimize potential interior damage to the roofing assembly and to the interior of the building.
 - 3. **Tapered edge strips, crickets or saddles** are recommended where periodic ponding of water may occur. When the slope of the taper exceeds 2” to one horizontal foot additional membrane securement at the base of the tapered edge strip, cricket or saddle will be required.
 - 4. On **VersiGard White EPDM Roofing Systems**, a slope greater than 1/8” per horizontal foot is recommended to serve the long-term aesthetics.
- H. On new construction projects, especially in cold climate regions, moisture generated due to the construction process could adversely impact various components within the roofing assembly if not addressed. Refer to [Design Reference DR-01 “Construction Generated Moisture”](#) included in the Versico Technical Manual.

I. Vapor Retarders

1. Versico does not require a vapor retarder for the protection of the membrane; however, it should be considered by the specifier for the protection of the roofing assembly including insulation, underlayment and adhesives.
2. The following criteria should be considered by the specifier:
 - 1) In the generally temperate climate of the United States, during the winter months, water vapor flows upward from a heated, more humid interior toward a colder, drier exterior. Vapor retarders are more commonly required in northern climates than in southern regions, where downward vapor pressure may be expected and the roofing membrane itself becomes the vapor retarder.
 - 2) On structural concrete decks, when a vapor retarder is not used, gaps in the deck along the perimeter and around penetrations must be sealed along with vertical joints between tilt-up panels, if present, to prevent infiltration of hot humid air and possible moisture contamination resulting from condensation. This is specifically important when polyurethane adhesive is used to attach the roof insulation.
 - 3) When a vapor retarder is specified, Versico VapAir Seal 725TR or VapAir Seal MD Air and Vapor Barrier may be used. Refer to Part II "Products" for necessary information and [Spec Supplement G-08 "Application Procedures for 725TR Air and Vapor Barrier"](#) for product installation.
 - 4) On cold storage/freezer facilities, the perimeter and penetration details must be selected to provide an air seal and prevent outside air from infiltrating and condensing within the roofing assembly. Consult latest publications by ASHRAE (American Society of Heating, Refrigerating and Air-Conditioning Engineers, Inc.) and NRCA (National Roofing Contractors Association) for specific information.
 - 5) All Versico roofing membranes are tested and pass in accordance with ASTM E 2178 and shall qualify as an air barrier when following Versico specifications and details for roofing applications.

NOTE: If left unaddressed, collected moisture could weaken insulation boards and facers resulting in a blow-off or increase the probability of mold growth.

J. Retrofit- Recover Projects (when the existing roofing material is left in place)

1. The removal of existing wet insulation and membrane must be specified. The Specifier shall select an appropriate and compatible material as filler for voids created by removal of old insulation or membrane.
2. A core cut should be taken to verify weight of existing components when the roofing system is to be specified over an existing roofing assembly.
3. Entrapment of water between the old and new membrane can damage and deteriorate new insulation/underlayment between the two membranes. If a vapor retarder or air barrier is not specified, Versico recommends the existing membrane be perforated to avoid potential moisture accumulation and to allow the detection of moisture to enable the building owner to take corrective action. This can be accomplished by drilling approximately 3/4" diameter holes every 100 square feet in the existing built-up roof or single-ply membrane (excluding PVC membrane).
4. Existing PVC membrane must be totally removed or the existing membrane must be cut into maximum 10' by 10' sections. All PVC flashings at the perimeter, roof drains and roof penetrations must be removed.

K. Optional Color Coating

1. Versico X-Tenda Coat is recommended for color coating the EPDM membrane and flashing when required by the Specifier. Available in white or gray.

X-Tenda Coat can also be specified as a "Restoration System" when applied to an existing Versico EPDM membrane system that may qualify for a 5- or 10-year Coating System Warranty. Refer to Versico's published X-Tenda Coat Specification for specific requirements.

NOTE: Versico may be contacted for other optional color coatings.

1.03 Quality Assurance

Building codes are above and beyond the intended purpose of this specification. The building **owner, owner's representative** or **Specifier** should verify local codes for applicable requirements and limitations. It is the responsibility of the specifier to review local, state and regional codes to determine their impact on the specified Versico Roofing System.

NOTE: For code approvals achieved with the Versico EPDM Roofing Systems, refer to the Versico EPDM Code Approval Guide, DORA (Directory of Roof Assemblies), Factory Mutual (FM) Approval Guide or Underwriters Laboratories (UL) Fire Resistance or Roofing Materials and Systems Directories.

- A. When recovering or retrofitting an existing roof system, the addition of new insulation (type and thickness) may alter the fire performance characteristics of the assembly. Building owners or their designated representatives shall consult the local code enforcement agency to avoid potential code violation.

- B. Versico recommends the use of Versico supplied products for use with these Versico Roofing Systems. The performance or integrity of products by others, **when selected by the specifier and accepted as compatible by Versico**, is not the responsibility of Versico and is **disclaimed** by the Versico Warranty.
- C. The specified roofing system must be installed by a Versico Authorized Roofing Contractor in compliance with drawings and specifications as approved by Versico.
- D. Provide polyisocyanurate insulation that meets PIMA Quality Mark Certified LTTR value through third party verification meeting ASTM C 1289, Type II, Class 1, Grade 2.
- E. There must be no deviations made from Versico's specification or Versico's approved shop drawings without the **PRIOR WRITTEN APPROVAL** of Versico.
- F. After completion of the installation, upon request, an inspection shall be conducted by a Field Service Rep (FSR) of Versico to ascertain that the membrane roofing system has been installed according to Versico's published specifications and details applicable at the time of bid. This inspection is to determine whether a warranty shall be issued. It is not intended as a final inspection for the benefit of the owner.
- G. For ballasted, 30-year warranty projects, the applicator must submit pictures showing the use of EPDM Primer for perimeter Quick-Applied RTS (Reinforced Termination Strip) securement or allow random test cuts to confirm the use of EPDM Primer.

1.04 Submittals

- A. To ensure compliance with Versico's minimum warrant requirements, the following projects should be forwarded to Versico for review prior to installation, preferably prior to bid.
 - 1. Air pressurized buildings, canopies, and buildings with large openings where the total wall openings exceed 10% of the total wall area on which the openings are located (such as airport hangars, warehouses and large maintenance facilities). Refer to Attachment IV at the end of this section for perimeter considerations, when a Mechanically Attached System is specified.
 - 2. Cold storage buildings are freezer facilities.
 - 3. Design "A" Fully Adhered Roofing System projects over 250' in height (Up to 15 YR warranties) and over 100' in height (Warranties greater than 15 YR).
 - 4. Design "B" Ballasted Roofing System projects over 75' in height.
 - 5. Mechanically Attached Roofing System projects over 100' in height.
 - 6. Projects where the EPDM is expected to come in direct contact with petroleum-based products, waste products (i.e., grease, oil, animal fats, etc.) and other chemicals.
 - 7. Projects where hot asphalt is specified for insulation attachment.
 - 8. Mechanically Attached projects specified with a fastener length exceeding 12".
- B. Shop drawings must be submitted to Versico by the Versico Authorized Roofing Contractor along with a completely executed Copy-A Job Approval Request for approval. Approved shop drawings are required for inspection of the roof and on projects where on-site technical assistance is requested.

Shop drawings must include:

- 1. Outline of roof and size
 - 2. Deck type (for multiple deck types)
 - 3. Location and type of all penetrations
 - 4. Perimeter and penetration details
 - 5. Key plan (on multiple roof areas) with roof heights indicated
 - 6. Sheet width and number of perimeter sheets for Reinforced Mechanically Attached Systems
 - 7. Versico Fastener type, length and maximum spacing (for membrane securement) for Reinforced Mechanically Attached systems.
- C. **Along with the project submittals** (shop drawings and Request for Warranty), the roofing contractor must include pullout test results when the results are below the requirements identified in the Table included in [Design Reference DR-06 "Withdrawal Resistance Criteria"](#).
 - D. Ballasted projects incorporating a **lightweight insulating concrete** substrate, a **certification letter is required** from the lightweight insulation concrete manufacturer for the following conditions:
 - 1. The membrane is specified directly over **vermiculite** or **cellular** lightweight insulation concrete with a maximum compressive strength of 140 psi.

2. The membrane is specified with Versico's Protective Mat as the membrane underlayment over **vermiculite** or **cellular** lightweight insulation concrete with a compressive strength between 140-175 psi.

The certification letter must reference the project name and location, accompany the project submittals (shop drawing and Request for Warranty) and contain the following information pertaining to the lightweight insulation concrete mix design:

1. Manufacturer's brand name
 2. Maximum compressive strength
 3. Average wet density
 4. Average air dry density
- E. When field conditions necessitate modifications to the originally approved shop drawings, a copy of the shop drawings outlining all modifications must be submitted to Versico for revision and approval prior to inspection and warranty issuance.
- F. **As-Built Projects** (roofing systems installed prior to project approval by Versico)
The Versico Authorized Contractor may supply Versico with an As-Built drawing for a project completed prior to Versico's approval. The As-Built drawings:
1. Must conform to Versico's most current published specifications and details applicable at the time of bid.
 2. Must be submitted along with a completely executed Copy-B Job Completion form.
 3. Must include the items identified in Paragraphs B, C and D above.

Note: As-Built projects are not recommended for those projects referenced in Paragraph A in order to ensure Versico warranty requirements have been met.

G. **Copy-B Job Completion**

After project completion, a Copy-B Job Completion date must be submitted to Versico to schedule the necessary inspection and acceptance of the project prior to issuance of the Versico warranty.

1.05 Warranty

- A. A Total System Warranty is available for roofing systems on commercial buildings within the United States and applies only to **products manufactured or marketed by Versico**. The total system is defined as membrane, flashings, adhesives, sealants and other Versico brand products utilized in the installation. For a complete description of these products, refer to the Part 2 "Products" Section included in this Specification and [Spec Supplement "Related Products" P-01](#).
- B. **See Tables Below for information regarding Warranted Systems and Design Criteria:**
1. **TABLE I – Non-Reinforced EPDM Membrane Thickness for Various Warranty Options** Identifies minimum membrane thickness for non-reinforced membranes used in Fully Adhered or Ballasted roofing systems.
 2. **TABLE II – Reinforced EPDM Membrane Thickness for Various Warranty Options** Identifies minimum membrane thickness required for Fully Adhered and Mechanically Attached assemblies using reinforced membrane.
 3. **TABLE III – Mechanically Fastened Roofing Systems - Membrane Fastening Criteria – Up to 20 YR Warranty - Steel/Concrete Decks** Identifies fastening density, field membrane width and number perimeter sheets required for the various wind zones. The assemblies are categorized based on various building height and specific wind speed warranty coverage.
 4. **TABLE IV – Mechanically Fastened Roofing Systems - Membrane Fastening Criteria – Up to 20 YR Warranty - Wood (Plywood & OSB) Deck** Identifies fastening density, field membrane width and number perimeter sheets required for the various wind zones. The assemblies are categorized based on various building height and specific wind speed warranty coverage.
 5. **TABLE V – Re-roofing Substrate Criteria - Up to 20 YR Warranty** Identifies required substrates for re-roofing applications for Fully Adhered, Mechanically Attached and Ballasted roofing systems.
 6. **TABLE VI – Adhered Roofing Systems - Underlayment Fastening Criteria - Up to 20 YR Warranty** Identifies required underlayment for Fully Adhered roofing systems with warranties up to 20 years based on the various

wind speed coverage available. The Table also identifies fastening density of adhesive bead spacing and required edge terminations.

7. **TABLE VII – Underlayment/Insulation & Required Attachment Assemblies - Up to 20 YR Warranty for QA EPDM Adhered Roofing Systems** Identifies required underlayment for QA EPDM Fully Adhered roofing systems with warranties up to 20 years based on the various wind speed coverage available. The Table also identifies fastening density of adhesive bead spacing and required edge terminations.

Table I Non-Reinforced EPDM Membrane Thickness for Various Warranty Options

VERSIGARD OR VERSIGARD WHITE NON-REINFORCED MEMBRANES - ADHERED				
Warranty Duration	Warranty Wind Speed Coverage		Minimum Membrane Thickness	Hail Coverage
	55, 72, 80 or 90 mph	100 to 120 mph		*(Cover Board set in Adhesive)
5,10, or 15 year	√	√ (4)	60-mil VersiGard OR VersiGard White 60-mil VersiGard QA OR VersiGard White QA	1" for Adhered*
20 year	√	√ (4)	60-mil VersiGard OR VersiGard White 60-mil VersiGard QA OR VersiGard White QA	1" for Adhered*
25 year (3)	√ (1)	√ (4)	60-mil VersiGard OR VersiGard White 60-mil VersiGard QA OR VersiGard White QA	1" for Adhered*
30 year (3)	√ (1)	√	90-mil VersiGard OR VersiGard White	2" for Adhered*
VERSIGARD OR VERSIGARD WHITE NON-REINFORCED MEMBRANES - BALLASTED				
Warranty Duration	Warranty Wind Speed Coverage		Minimum Membrane Thickness	Hail Coverage
	55, 72 or 80 mph			
5,10, 15, 20 or 25 year (3)	√ (2)		VersiGard 45-mil	1" for Ballasted
5,10, 15 or 20 year	√ (2)		60-mil VersiGard OR VersiGard White	2" for Ballasted
25 or 30 year (3)	√ (2)		60-mil VersiGard OR VersiGard White	2" for Ballasted
30 year (3)	√ (2)		90-mil VersiGard OR VersiGard White	3" for Ballasted

Notes:

N/A = Not Acceptable

√ = Acceptable

(1) G200-SA Yellow Substrate Adhesive or EPDM x-23 Low-VOC, Low-VOC EPDM/TPO or CAV-GRIP 3V Bonding Adhesive must be utilized.

(2) When VersiGard Reinforced membrane is specified, 60-mil membrane minimum is required for warranties for up to 20 years. Projects with 25 / 30 year warranty must incorporate 75-mil membrane.

(3) See Attachment II '25/30 Year Warranty Design Enhancements' for enhanced design requirements.

(4) Versico's Accidental Puncture Warranty covers labor hours and material used during the repair. Maximum labor and material hours are dependent upon system design. Refer to the Warranty Availability Quick Reference Guide for coverage.

(5) VersiGard QA and VersiGard White QA limited to maximum 100 mph warranty wind speed coverage.

Table II Reinforced EPDM Membrane Thickness for Various Warranty Options

Warranty Duration	VersiGard or VersiGard WHITE Reinforced Membranes						
	Warranty Wind Speed Coverage				Minimum Membrane Thickness	Hail Coverage * (Cover Board set in Adhesive)	Puncture Coverage (3)
	55, 72, 80 or 90 mph		100 to 120 mph				
	Fully Adhered	Mech. Attached	Fully Adhered	Mech. Attached			
5,10, or 15 year	√	√	√	N/A	45-mil VersiGard	N/A	8 man hours
20 year	√	√	√	N/A	60-mil VersiGard, 60-mil VersiGard White Reinforced, OR 60-mil VersiGard QA	1" for Adhered*	16 man hours
25 year (2)	√ (1)	√	√ (1)	N/A	75-mil VersiGard OR 60-mil VersiGard QA	2" for Adhered*	32 man hours
30 year (2)	√ (1)	√	√ (1)	N/A	75-mil VersiGard	2" for Adhered*	32 man hours

Notes: N/A = Not Acceptable √= Acceptable

(1) G200-SA Yellow Substrate Adhesive or EPDM x-23 Low-VOC, Low-VOC EPDM/TPO or CAV-GRIP 3V Bonding Adhesive must be utilized.

(2) See Attachment II '25/30 Year Warranty Design Enhancements' for enhanced design requirements.

(3) Versico's Accidental Puncture Warranty covers labor hours and material used during the repair. Maximum Availability Quick Reference Guide for coverage.

Mechanically Fastened Membrane Fastening Criteria

Table III

Up to 20 YR Warranty (1)

22 GA. Steel, Structural Concrete, Wood Plank, and 3/4" Plywood Decks

Peak Gust Wind Speed Warranty	Max. Building Height	Min. Number of Perimeter Sheets			Field Membrane Width	Perimeter Sheet Width***	Fastening Density* (Field & Perimeter Sheets)
		Building Distance from Coastline					
		Greater than 7 miles	3 to 7 miles	Less than 3 miles			
55 MPH	Up to 60'	1	2	3	10'	6.5'	12" O.C.
					8'	6.5'	12" O.C.
	61' to 100'	2	2	3	10'	6.5'	6" O.C.**
					8'	6.5'	12" O.C.
72 MPH	Up to 60'	2	2	3	10'	6.5'	12" O.C.
					8'	6.5'	12" O.C.
	61' to 100'	3	4	4	10'	6.5'	6" O.C.**
					8'	6.5'	12" O.C.
80 MPH	Up to 60'	3	3	4	10'	5****	12" O.C.
					8'	5****	12" O.C.
	61' to 100'	3	4	4	10'	5****	6" O.C.**
					8'	5****	12" O.C.
90 MPH	Up to 60'	3	4	4	10'	5****	6" O.C.**
					8'	5****	12" O.C.
	61' to 100'	4	5	5	10'	5****	6" O.C. **
					8'	5****	12" O.C.

* Using HPV Fasteners on Steel Deck, Wood Plank and 3/4" Plywood Decks with Polymer Seam Plates.

**12" o.c. Spacing can be utilized by using HPV-XL Fasteners and 2-3/8" Polymer Seam Plates.

***As an option, 9" wide EPDM Quick-Applied RTS can be used beneath the field sheets for perimeter securement.

- (1) 20 year is the maximum warranty available with peak gust wind speed of 90 MPH. Projects with greater wind speed coverage **MUST** be submitted to Versico for review and possible considerations.

Mechanically Fastened Roofing Systems Fastening Criteria

Table IV

Up to 20 YR Warranty

Wood (Plywood or OSB) Decks

Peak Gust Wind Speed Warranty	Deck Type	Projected Pull-Out Values	Min. Number of Perimeter Sheets			Field Membrane Width	Perimeter Sheet Width	Fastening Density (Field & Perimeter Sheets)
			Building Distance from Coastline					
			Greater than 7 miles	3 to 7 miles	Less than 3 miles			
55 MPH	7/16" OSB	210 lbs	2	3	3	10'	5*	9" O.C.
			2	3	3	8'	5*	12" O.C.
	15/32" 3-Ply Plywood	240 lbs	2	2	3	8'	5*	12" O.C.
	15/32" 5-Ply Plywood	530 lbs	1	2	3	10'	6.5'	12" O.C.
	5/8" OSB	310 lbs	2	3	3	10'	5*	12" O.C.
2			3	3	8'	5*	12" O.C.	
72 MPH	15/32" 3-Ply Plywood	240 lbs	2	2	3	8'	5*	12" O.C.
	15/32" 5-Ply Plywood	530 lbs	2	2	3	10'	6.5'	12" O.C.
	5/8" OSB	310 lbs	2	3	3	10'	5*	12" O.C.
			2	3	3	8'	5*	12" O.C.
80 MPH	<i>Contact Versico for Approval and Evaluation</i>							

*Maximum duration for OSB shall not exceed 20 Years.

Re-roofing Substrate Criteria (Up to 20 YR Warranty)

Table V

Acceptable Roof Deck/Substrate	EPDM Membrane (See Table I and II for minimum membrane thickness)		
	Fully Adhered - Design "A"	Ballasted - Design "B"	Mechanically Attached
RETROFIT / NO TEAR-OFF			
Existing Smooth Surface BUR or Mineral Surface Cap Sheet	Direct Application	Insulation	Direct Application
Gravel Surfaced BUR	Insulation	Insulation	Insulation
Coal Tar Pitch	Insulation	Insulation	Insulation
Modified Bitumen	Direct Application	Insulation	Direct Application
Existing Single-Ply	Insulation	Insulation	Direct Application (1)
Sprayed-in-place Urethane	Complete Tear-off Required	Insulation	Complete Tear-off Required

(1) Direct application over existing PVC is not permitted regardless of warranty duration. Versico may be contacted for specific substrate requirement.

NOTE: Projects with Warranties greater than 20 YR require total removal of existing materials. Refer to Table VI and VII for further material requirements.

NOTE: Refer to Roof Deck and Substrate Criteria Table in Part III for additional installation requirements.

Fully Adhered Roofing Systems Underlayment Fastening Criteria Up to 20 YR Warranty

Table VI

Other Requirements are Listed in Additional Design Considerations following this Table

All Versico Products listed for higher wind speed coverage can also be used for Warranties for lower speed coverage.

(i.e. 72 MPH underlayment may be used for 55 MPH underlayment)

Maximum Peak Gust Wind Speed Warranty	Minimum Membrane Underlayment	Insulation/Underlayment Attachment			Metal Edging
		# of Fasteners per 4' x 8' board size	Adhesive Ribbon Spacing for 4' x 4' size board (12)		
			Field	Perimeter	
55 or 72 MPH	1" (20 psi) Polyisocyanurate or 1" (20 psi) Polyisocyanurate Eco	16	12" (5)(6) (12)	6" (5)	Versico Drip Edge
	1-1/2" (20 psi) Polyisocyanurate or 1-1/2" (20 psi) Polyisocyanurate Eco	10			
	2"(20 psi) Polyisocyanurate Or 2" (20 psi) Polyisocyanurate Eco	8			
	1/2" SecurShield HD or 1/2" SecurShield HD Eco (2)	12			
	1/4" DensDeck Prime, 1/4" Securock, 1/4" Securock Ultralight Coated Glass Mat, 1/4" DEXcell® Glass Mat, or 1/4" DEXcell FA™ Glass Mat (2)	12			
80 MPH	1/2" SecurShield HD Plus (2)	8	12" (5)(6)(7) (12)	6" (5)(7)	Versico Drip Edge (11)
	1/2" Versico Recovery Board (2)(13)	16			
	1/2" SecurShield HD AND 1/2" SecurShield HD Eco (2)	16			
	2" SecurShield HD Composite	6			
	1/2" DensDeck Prime, 1/2" Securock, 1/2" Securock Ultralight Coated Glass-Mat Board, 1/2" DEXcell® Glass Mat, 7/16" DEXCell® Cement Board or 1/2" DEXcell FA™ Glass Mat (2)	8			
	1-1/2" Polyisocyanurate(25 psi) Or 1-1/2" (25 psi) Polyisocyanurate Eco	10			
	2" (25 -psi) Polyisocyanurate Or 2" (25 psi) Polyisocyanurate Eco	8			
90 MPH	1/2" DensDeck Prime, 1/2" Securock, 1/2" Securock Ultralight Coated Glass-Mat, 1/2" DEXcell® Glass Mat, 7/16" DEXCell® Cement Board or 1/2" DEXcell FA™ Glass Mat (2)	12	6" (9)	6" (7)(8)	Versico Drip Edge (3)(4), or VersiTrim EX Snap-On or VersiTrim Snap-On Fascia
	1/2" SecurShield HD, 1/2" SecurShield HD Eco, 1-1/2" (20-psi) SecurShield Polyiso or 1-1/2" (20-psi) SecurShield Eco (2)	16			
	1/2" SecurShield HD Plus or 1/2" DuraStorm VSH (2)	12			
	2" (20-psi) SecurShield, 2" (20-psi) SecurShield Eco or 2" SecurShield HD Polyiso Composite (2)	8			
	1-1/2" DuraFaceR (OSB/Polyiso Composite) (2)	8			
	1-1/2" Insulfoam HD Composite	16			
100 MPH	2" (25-psi) SecurShield Polyiso or 2" (25-psi) SecurShield Eco	16	FS	FS	Versico Drip Edge (3)(4) VersiTrim EX Snap-On or SecurEdge Snap-On Fascia
110 MPH	1-1/2" DuraFaceR (OSB/Polyiso Composite) or 1/2" DuraStorm VSH (2)	16	FS	FS	VersiTrim EX Snap-On or SecurEdge Snap-On Fascia
	1/2" SecurShield HD Plus (2)				
120 MPH	5/8" DensDeck Prime, 5/8" DensDeck StormX Prime, 5/8" Securock or 5/8" Securock Ultralight Coated Glass-Mat, 5/8" DEXcell FA™ Glass Mat, 5/8" DEXcell® Cement Roof Board or 5/8" DEXcell FA VSH® (2)	16	FS	FS	VersiTrim EX Snap-On or SecurEdge Snap-On Fascia
	1-1/2" DuraFaceR (OSB/Polyiso Composite) or DuraStorm VSH (2)	17			
	1/2" SecurShield HD Plus (2)	24			
	2" SecurShield HD Composite	16			

FS = Full Spray or Ribbons @ 4" O.C.

- (1) Not used.
- (2) For Steel Decks, Cover boards must be installed over a min. 1" thick approved Versico Insulation.
- (3) Versico HPV or HPVX Fasteners must be used to secure Versico Drip Edge or VersiTrim Snap-On Metal Fascia to perimeter wood nailers.
- (4) Membrane securement is required at the base of the VersiTrim Drip Edge waterdam.
- (5) Gravel Surface BUR - Field @ 6" O.C. / Perimeter @ 4" O.C.
- (6) Steel Decks - Field & Perimeter @ 6" O.C.
- (7) Cementitious Wood Fiber - Field @ 6" O.C. / Perimeter @ 4" O.C.
- (8) Smooth BUR - Field @ 6" O.C. / Perimeter @ 4" O.C.
- (9) Gravel Surface BUR – FS
- (10) Not used.
- (11) May be fastened with ring shank nails staggered 4" on center. Versico HPV or HPVX Fasteners may also be used fastened 12" on center.
- (12) Gypsum Deck must have a minimum 6" o.c. bead spacing.
- (13) Versico Recovery Board cannot exceed 15 YR. Warranty for reroof and no tear-off projects only.

Table VI - Additional Adhered Design Considerations - Up to 20 YR Warranty

- 1 – For building heights between 51-100', enhance 12'-wide perimeter with 50% more fasteners and plates.
- 2 – Building height shall not exceed 100'*
- 3 – Acceptable decking: 22-gauge or heavier steel, structural concrete, 1-1/2" wood plank, or 15/32" plywood**
- 4 – See DR-05 for insulation fastening patterns.

* For projects where building height exceeds 100', please submit to Versico for review.

** 16 fasteners per 4' x 8' board are required for the following decks: OSB, gypsum, cementitious, wood fiber (Tectum), lightweight insulated concrete over steel roof deck thinner than 22-gauge and steel roof deck thinner than 22-gauge. Warranties are limited to a 20-year, 72-mph wind speed.

* For projects where building height exceeds 100', please submit to Versico for review.

** 16 fasteners per 4' x 8' board are required for the following decks: OSB, gypsum, cementitious, wood fiber (Tectum), lightweight insulated concrete over steel roof deck thinner than 22-gauge and steel roof deck thinner than 22-gauge. Warranties are limited to a 20-year, 72-mph wind speed.

Underlayment/Insulation & Required Attachment Assemblies Up to 20 YR Warranty for QA EPDM Adhered Roofing Systems

Table VII

Other Requirements are Listed in Additional Design Considerations following this Table.

All Versico Products listed for higher wind speed coverage can also be used for Warranties for a lower speed coverage. (i.e. 72 MPH underlayment may be used for 55 MPH underlayment)

Peak Gust Wind Speed Warranty	Minimum Membrane Underlayment	Insulation Attachment		Metal Edging	
		# of Fasteners per 4' x 8' board size	Adhesive Ribbon Spacing for 4' x 4' size board (13)		
			Field		Perimeter
55 or 72 MPH	1" (20 psi) Polyisocyanurate Or 1" (20 psi) Polyisocyanurate Eco	16 (9)	12" (4)(5)	6" (4)	Versico Drip Edge
	1-1/2" (20 psi) Polyisocyanurate Or 1-1/2" (20 psi) Polyisocyanurate Eco	10			
	2" (20 psi) Polyisocyanurate Or 2" (20 psi) Polyisocyanurate Eco	8			
	1/2" SecurShield HD or 1/2" SecurShield HD Eco (2)	12			
	1/4" DensDeck Prime, 1/4" Securock, 1/4" Securock Ultralight Coated Glass-Mat, 1/4" DEXcell® Glass Mat, or 1/4" DEXcell FA™ Glass Mat (2)				
	2" (1.25 lb/density) Insulfoam SP*				
80 MPH	1/2" DensDeck Prime or 1/2" Securock 1/2" Securock Ultralight Coated Glass-Mat, 1/2" DEXcell® Glass Mat, 7/16" DEXCell® Cement Board or 1/2" DEXcell FA™ Glass Mat (2)	8	12" (4)(5)(6)(13)	6" (4)(6)	Versico Drip Edge (12)
	1/2" SecurShield HD or 1/2" SecurShield HD Eco (2)	16			
	1/2" SecurShield HD Plus (2)	8			
	2" SecurShield HD Composite	6			
	1-1/2" (25-psi) Polyisocyanurate	10			
	2" (25 -psi) Polyisocyanurate	8			
	2" (1.25 lb/density) Insulfoam SP**	16			
	1-1/2" Insulfoam HD Composite*	12			
90 MPH	1/2" DensDeck Prime, 1/2" Securock 1/2" Securock Ultralight Coated Glass-Mat, 1/2" DEXcell® Glass Mat, 7/16" DEXCell® Cement Board or 1/2" DEXcell FA™ Glass Mat (2)	12	6" (8)	6" (6)(7)	Versico Drip Edge (10)(11), or VersiTrim EX Snap-On or VersiTrim Snap-On Fascia
	1/2" SecurShield HD, 1/2" SecurShield HD Eco , 1-1/2" (20-psi) SecurShield Polyiso or 1-1/2" (20-psi) SecurShield Eco (2)	16			
	1/2" SecurShield HD Plus or 1/2" DuraStorm VSH (2)	12			
	1-1/2" DuraFaceR (OSB/Polyiso Composite)	8			
	2" (20-psi) SecurShield Polyiso, 2" (20-psi) SecurShield Eco or 2" SecurShield HD Composite	8			
	1-1/2" Insulfoam HD Composite	16			
100 MPH	5/8" DensDeck Prime, 5/8" DensDeck StormX Prime, 5/8" Securock, 5/8" Securock Ultralight Coated Glass-Mat, 5/8" DEXcell FA™ Glass Mat, 5/8" DEXcell® Cement Roof Board or 5/8" DEXcell FA VSH® (2)	16	FS	FS	Versico Drip Edge (10)(11) VersiTrim EX Snap-On or SecurEdge Snap-On Fascia
	1/2" SecurShield HD Plus (2)				
	1-1/2" DuraFaceR (OSB/Polyiso Composite) or 1/2" DuraStorm VSH				
	2" (25-psi) SecurShield Polyiso or 2" (25-psi) SecurShield Eco (1)				
	2" SecurShield HD Composite				

FS = Full Spray or Ribbons @ 4" O.C.

- (1) Not used.
 - (2) Cover boards must be installed over a minimum 1" thick approved Versico Insulation.
 - (3) Not Used.
 - (4) Gravel Surface BUR - Field @ 6" O.C. / Perimeter @ 4" O.C.
 - (5) Steel Decks - Field & Perimeter @ 6" O.C.
 - (6) Cementitious Wood Fiber - Field @ 6" O.C. / Perimeter @ 4" O.C.
 - (7) Smooth BUR - Field @ 6" O.C. / Perimeter @ 4" O.C.
 - (8) Gravel Surface BUR – FS
 - (9) Not used.
 - (10) Versico HPV or HPVX Fasteners must be used to secure Versico Drip Edge or VersiTrim 200 Metal Fascia to perimeter wood nailers.
 - (11) Membrane securement is required at the base of the VersiTrim 200 waterdam.
 - (12) May be fastened with ring shank nails staggered 4" on center. Versico HPV or HPVX Fasteners may also be used fastened 12" on center.
 - (13) Gypsum deck must have minimum 6" o.c. bead spacing.
- *Maximum warranty available 20 year.
** Maximum warranty available 15 year.

Table VII - Additional Design Considerations (Up to 20 YR Warranty)

- 1 – For Building heights between 51-100', enhance 12'-wide perimeter with 50% more fasteners and plates.
 - 2 - Minimum membrane thickness 60-mil QA EPDM
 - 3 - Building height shall not exceed 100**
 - 4 - See DR-05 for insulation fastening patterns.
 - 5 - Acceptable decking: 22-gauge or heavier steel, structural concrete, 1-1/2" wood plank, or 15/32" plywood.
 - 6 - All "T-joints" must be overlaid with appropriate flashing material or Versico "T-Joint" Covers.
- *Projects where building height exceeds 100' or warranty wind speed exceeds 100 mph, shall be submitted to Versico for review.

C. Access for warranty service

It shall be the owner's responsibility to expose the membrane in the event warrant service is required when access is impaired. Such impairment includes, but is not limited to:

1. Design features, such as window washer systems, which require the installation of traffic surface units in excess of 100 pounds per unit.
2. Any equipment, ornamentation, building service units and other top surfacing materials, which are not defined as part of this specification.
3. Photovoltaic and mounting systems or other rooftop equipment which does not provide Versico with reasonable access to the membrane system for purposes of warranty investigation and related repairs.
4. Severely ponded conditions.

CAUTION: APPLICATIONS SUCH AS WALKING DECKS, TERRACES, PATIOS OR AREAS SUBJECTED TO CONDITIONS NOT TYPICALLY FOUND ON ROOFING SYSTEMS WILL **NOT** BE ELIGIBLE FOR A MEMBRANE SYSTEM WARRANTY. VERSICO MAY BE CONTACTED FOR OTHER AVAILABLE OPTIONS.

- D. The formation or presence of mold or fungi in a building is dependent upon a broad range of factors including, but not limited to, the presence of spores and nutrient sources, moisture, temperatures, climatic conditions, relative humidity, and heating/ventilating systems and their maintenance and operating capabilities. These factors are beyond the control of Versico and Versico shall not be responsible for any claims, repairs, restoration or damages relating to the presence of any irritants, contaminants, vapors, fumes, molds, fungi, bacteria, spores, mycotoxins, or the like in any building or in the air, land, or water serving the building.

1.06 JOB CONDITIONS

- A. On phased roofing, temporary closures should be provided to prevent moisture infiltration. When a temporary roof is specified, Versico 725-TR in conjunction with CCW-702, CCW-702 LV or CAV-GRIP 3V Primer may be used. Refer to Product Section Part II for additional product information and [Spec Supplement G-07 "Application Procedures for 725TR Air and Vapor Barrier"](#).
- B. When possible on multiple level roofs, begin the installation on the highest level to avoid or minimize construction traffic on completed roof sections.

- C. On projects at high altitudes (6,000' and above) rapid flash-off (drying) of substrate adhesive and primers will occur due to low atmospheric pressure.
- D. Wood nailers are required for the securement of metal edgings, scuppers, and insulated pipes. Treated or non-treated wood nailers may be specified and shall be secured per specifier recommendation or in accordance with Factory Mutual's Property Loss Prevention Data Sheet 1-49. Refer to [Design Reference DR-08 "Wood Nailers and Securement Criteria"](#) in Versico Technical Manual shall be reference.
- E. For fully adhered or mechanically attached systems specified over existing standing seam, flat seam or corrugated metal roofs, refer to the Versico's Metal Retrofit Roofing System Specifications.
- F. When any of the EPDM Roofing Systems are specified on a portion of a roof, tie-ins to existing roofing membranes will be required. Depending on the type of the existing roofing system, the tie-in method will vary. Total isolation between two roofing systems or weep holes may be required to address moisture migration from one roofing system to the other. Prior to the selection of any tie-in detail, ensure the selected detail will not restrict drainage.

1.07 Product Delivery, Storage and Handling

- A. Deliver materials to the job site in **original**, unopened containers.
- B. When loading materials onto the roof, the Versico Authorized Roofing Contractor must comply with the requirements of the specifier/owner to prevent overloading and possible disturbance to the building structure.
- C. Job site storage temperatures in excess of 90°F (32°C) may affect shelf life of curable materials (i.e., uncured flashing, adhesives, sealants, primers, QA Seam Tape and Quick-Applied Flashing/Accessories).
- D. **When the temperature is expected to fall below 40°F (4°C)**, outside storage boxes should be provided on the roof for temporary storage of liquid adhesives, sealants, primers, QA Seam Tape and Quick-Applied Flashing/accessories. Containers must be rotated to maintain their temperature above 40°F (4°C). Refer to Technical Data Bulletins for individual products for temperature restrictions.

NOTE: Prolonged exposure of quick-applied flashing and QA Seam Tape to temperatures below 40°F (4°C) will cause the pre-applied adhesive tape to lose tack and in extreme cases, not bond to the substrate. Refer to [Spec Supplement E-02 "EPDM Membrane Splicing and Slice Repairs"](#) in Versico's Technical Manual for application procedures in colder temperatures.

- E. Do not store adhesive containers with opened lids due to the loss of solvent, which will occur from flash-off.
- F. Insulation/underlayment must be stored so it is kept dry and is protected from the elements. Store insulation on a skid and completely cover with a breathable material such as a tarp or canvas. If the insulation is lightweight, it should be weighted to prevent possible wind damage.

Part II- Products

2.01 General

The components of this roofing system are to be products of Versico or accepted by Versico as compatible. The installation, performance or integrity of products by others, **when selected by the specifier and accepted by Versico**, is not the responsibility of Versico and is expressly disclaimed by the Versico warranty.

2.02 Membrane

A. VersiGard (Black and White) Non-Reinforced EPDM Membranes

1. Cured non-reinforced EPDM (Ethylene, Propylene, Diene Terpolymer) compounded elastomer.

45-mil thick (black membrane only), 60-mil thick (black, gray or white), or 90-mil thick (black or white). Non-reinforced EPDM membrane is available in VersiGard (black), VersiGard (gray) or VersiGard White (white). VersiGard Gray is only available in 60-mil thickness. VersiGard White membranes are installed with the white surface facing up. VersiGard (black) membrane with thickness up to 60-mil can be available in widths up to 50' and lengths up to 150' (200' for 45-mil membrane only). VersiGard White membrane with thickness of 60-mil is available up to 20' widths and lengths up to 150' long. VersiGard Black / VersiGard White 90-mil and Sure-Seal Gray 60-mil membranes are available in widths up to 10' and lengths up to 100'. Membrane conforms to ASTM D4637, Type I (non-reinforced) and to ASTM E2178 as an air barrier.

2. **VersiGard Clean (black) EPDM Membrane** (mica dust has been removed during manufacturing) is available for sheets maximum 10' wide.
3. **VersiGard Gray Non-Reinforced EPDM Membrane** is available with and without QAT.
4. Refer to the physical properties listed on the following pages.

B. VersiGard Reinforced EPDM Membranes

1. Cured reinforced EPDM (Ethylene, Propylene, Diene Terpolymer) compounded elastomer. **VersiGard Reinforced EPDM Membrane** is only available in black.

45-, 60- or 75-mil thick VersiGard Reinforced EPDM Membrane is available in sizes referenced in Table below. Reinforced membrane with polyester fabric conforms to ASTM D4637, Type II (reinforced) and to ASTM E2178 as an air barrier.

VersiGard Reinforced Membrane Size Availability*			
Membrane Thickness	Sheet Sizes		
45-mil	5' or 6.5' X 100'	-	10' x 50' or 100'
60-mil	5' or 6.5' X 100' 5' x 200'	8' x 100'	10' x 50' or 100'
75-mil	-	-	10' x 50' or 100'

*Contact Versico for other custom sizes available.

2. **60-mil thick Versi-Gard WHITE Reinforced EPDM** membrane is available in a 10' x 100' sheet size.
3. Refer to the physical properties listed on the following pages

45-, 60-, AND 90-MIL THICK NON-REINFORCED EPDM MEMBRANE

45-mil thick VersiGard (standard) non-reinforced EPDM membrane is used only for VersiGard Design “B” Loose Laid Ballasted Roofing Systems.

60- or 90-mil thick VersiGard (black) and VersiGard White (white on black) and 60-mil thick VersiGard (gray) non-reinforced EPDM membrane is used primarily for fully adhered roofing systems. Membranes can also be used for ballasted and protected membrane assemblies.

NOTE: Although 60-mil Non-Reinforced EPDM is recommended for Adhered Roofing Systems, 45-mil thick FR Non-Reinforced EPDM may be utilized, if specified.

VERSIGARD (BLACK AND GRAY)/VERSIGARD WHITE (WHITE) NON-REINFORCED MEMBRANES						
Physical Property	Test Method	ASTM SPEC. (Pass)	Typical			
			45-mil	60-mil	60-mil	90-mil
			FR	FR	White and Gray	VersiGard Black FR/ VersiGard White
Tolerance on Nominal Thickness, %	ASTM D 412	±10	±10	±10	±10	±10
Weight, lb./ft ² (kg/m ²)			0.26 (1.3)	0.35 (1.7)	0.39 (1.9)	0.59 (2.9)**
Tensile Strength, min, psi (MPa)	ASTM D 412	1305 (9)	1600 (11)	1600 (11)	1600 (11)	1600 (11)
Elongation, Ultimate, min, %	ASTM D 412	300	480	465	540	540
Tear Resistance, min, lbf/in (kN/m)	ASTM D 624 (Die C)	150 (26.3)	200 (35.0)	200 (35.0)	200 (35.0)	200 (35.0)
Factory Seam Strength, min.	Modified ASTM D 816	Membrane Rupture	Membrane Rupture	Membrane Rupture	Membrane Rupture	Membrane Rupture
Resistance to Heat Aging* Properties after 4 weeks @ 240°F (116°C)	ASTM D 573					
Tensile Strength, min, psi (MPa)	ASTM D 412	1205 (8.3)	1500 (10.3)	1450 (10)	1345 (9.3)	1450 (10)
Elongation, Ultimate, min, %	ASTM D 412	200	225	280	280	280
Tear Resistance, min, lbf/in (kN/m)	ASTM D 624	125 (21.9)	215 (37.6)	215 (37.6)	185 (32.4)	215 (37.6)
Linear Dimensional Change, max, %	ASTM D 1204	±1.0	-0.4	-0.5	-0.2	-0.5
Ozone Resistance* Condition after exposure to 100 pphm Ozone in air for 168 hours @ 104°F (40°C) Specimen is at 50% strain	ASTM D 1149	No Cracks	No Cracks	No Cracks	No Cracks	No Cracks
Brittleness Temp., max, deg. F (deg. C)*	ASTM D 746	-49 (-45)	-49 (-45)	-49 (-45)	-67 (-55)	-49 (-45)
Resistance to Water Absorption* After 7 days immersion @ 158°F (70°C) Change in mass, max, %	ASTM D 471	+8.0, -2.0	[+2]	[+2]	[+3.3]	[+2.0]
Water Vapor Permeance* max, perm	ASTM E 96 (Proc. B or BW)	0.1	0.05	0.03	0.02	0.03
Resistance to Outdoor (Ultraviolet) Weathering* Xenon-Arc, total radiant exposure at .70 W/m ² irradiance, 176°F (80° C) black panel temp.	ASTM D 4637 Conditions	No Cracks No Cracking @7560 kJ/m ²	No Cracks No Cracking @41580 kJ/m ²	No Cracks No Cracking @41580 kJ/m ²	No Cracks No Cracking @25200 kJ/m ²	No Cracks No Cracking @41580 kJ/m ² @25200 kJ/m ² (white)

* Not a Quality Control Test due to the time required for the test or the complexity of the test. However, all tests are run on a statistical basis to ensure overall long-term performance of the sheeting.

** VersiGard White 90-mil Membrane Weight in lb/ft²(kg/m²) is equal to 0.60 (2.9)

60-MIL THICK REINFORCED EPDM MEMBRANE

The membrane is used for Mechanically Fastened or Adhered Roofing Systems.

VersiGard membranes are formulated with fire retardants to inhibit spread of flame and meets or exceeds UL Class A requirements for slopes up to 2", depending on the assembly.

VERSIGARD WHITE REINFORCED MEMBRANE			
Physical Property	Test Method	ASTM SPEC. (Pass)	Typical
			60-mil
Tolerance on Nominal Thickness, %	ASTM D 751	±10	±10
Weight, lb/ft ² (kg/m ²)			0.40 (2.0)
Thickness Over Scrim, min. in.(mm)	ASTM D 4637 Annex	0.015 (.381)	0.020 (.508)
Breaking Strength, min, lbf (N)	ASTM D 751 Grab Method (1)	90 (400)	225(996)
Elongation, Ultimate, min, %	ASTM D 751 Grab Method	250 **	480**
Tear Strength, min, lbf (N)	ASTM D 751 B Tongue Tear	10 (45)	70 (311)
Brittleness Temp., max. deg. F (deg. C)*	ASTM D 2137	[-49] (-45)	[-49] (-45)
Resistance to Heat Aging* Properties after 4 weeks @ 240°F	ASTM D 573		
Breaking Strength, min, lbf (N)	ASTM D 751	80 (355)	250 (1,110)
Elongation, Ultimate, min, %	ASTM D 412	200**	250**
Linear Dimensional Change, max, %	ASTM D 1204	±1.0	-1.0
Ozone Resistance* Condition after exposure to 100 pphm Ozone in air for 168 hours @ 104°F (40°C) Specimen wrapped around 3" mandrel	ASTM D 1149	No Cracks	No Cracks
Resistance to Water Absorption* After 7 days immersion @ 158°F (70°C) Change in mass, max, %	ASTM D 471	+8.0, -2.0	[5.2**]
Water Vapor Permeance* Max. perms	ASTM E 96 (Proc. B or BW)	0.10	0.02
Fungi Resistance	ASTM G 21	N/A	0 (No Growth)
Resistance to Outdoor (Ultraviolet) Weathering* Xenon-Arc, total radiant exposure at .70 W/m ² irradiance, 176°F (80° C) black panel temp.	ASTM G 155	No Cracks No Cracking @ 2,520 kJ/m ² 1,000 hrs.	No Cracks No Cracking @ 25,200 kJ/m ² 10,000 hrs.
At 0.35 W/m ² irradiance, 80°C black panel temperature		2,000 hrs.	20,000 hrs.
* Not a Quality Control Test due to the time required for the test or the complexity of the test. However, all tests are run on a statistical basis to ensure overall long-term performance of the sheeting.			
** Specimens to be prepared from coating rubber compound, vulcanized in a similar method to the reinforced product.			

45-, 60- OR 75-MIL THICK REINFORCED EPDM MEMBRANE

The membrane is used for Fully Adhered or Mechanically Attached Roofing Systems

The standard VersiGard membranes are formulated with fire retardants to inhibit spread of flame and meets or exceeds UL Class A requirements for slopes up to 3", depending on the assembly.

VERSIGARD REINFORCED MEMBRANES					
Physical Property	Test Method	ASTM SPEC. (Pass)	Typical		
			45-mil	60-mil	75-mil
Tolerance on Nominal Thickness, %	ASTM D 751	±10	±10	±10	±10
Weight, lb/ft ² (kg/m ²)			0.27 (1.3)	0.39 (1.9)	0.48 (2.3)
Thickness Over Scrim, min. in.(mm)	ASTM D 4637 Annex	0.015 (.381)	0.016 (.406)	0.020 (.508)	0.032 (0.81)
Breaking Strength, min, lbf (N)	ASTM D 751 Grab Method	90 (400)	140 (623)	140 (623)	177 (787)
Elongation, Ultimate, min, %	ASTM D 751 Grab Method	250 **	480**	480**	500**
Tear Strength, min, lbf (N)	ASTM D 751 B Tongue Tear	10 (45)	70 (311)	70 (311)	70 (311)
Brittleness Temp., max. deg. F (deg. C)*	ASTM D 2137	[-49] (-45)	[-49] (-45)	[-49] (-45)	[-49] (-45)
Resistance to Heat Aging* Properties after 4 weeks @ 240°F	ASTM D 573				
Breaking Strength, min, lbf (N)	ASTM D 751	80 (355)	182 (823)	182 (823)	182 (823)
Elongation, Ultimate, min, %	ASTM D 751	200**	250**	250**	250**
Linear Dimensional Change, max, %	ASTM D 1204	±1.0	-1.0	-1.0	-1.0
Ozone Resistance* Condition after exposure to 100 ppm Ozone in air for 168 hours @ 104°F (40°C) Specimen wrapped around 3" mandrel	ASTM D 1149	No Cracks	No Cracks	No Cracks	No Cracks
Resistance to Water Absorption* After 7 days immersion @ 158°F (70°C) Change in mass, max, %	ASTM D 471	+8.0, -2.0	[+5.5**]	[+5.5**]	[+5.5**]
Factory Seam Strength, min.	Modified ASTM D 816	Membrane Rupture	Membrane Rupture	Membrane Rupture	Membrane Rupture
Resistance to Outdoor (Ultraviolet) Weathering* Xenon-Arc, total radiant exposure at .70 W/m ² irradiance, 176°F (80° C) black panel temp.	ASTM D 4637 Conditions	No Cracks No Cracking @7560 kJ/m ²	No Cracks No Cracking @35320 kJ/m ²	No Cracks No Cracking @35320 kJ/m ²	No Cracks No Cracking @35320 kJ/m ²
* Not a Quality Control Test due to the time required for the test or the complexity of the test. However, all tests are run on a statistical basis to ensure overall long-term performance of the sheeting.					
** Specimens to be prepared from coating rubber compound, vulcanized in a similar method to the reinforced product.					

2.03 Insulations/Underlayments

A. General

1. Roof insulation thickness must be determined by the thermal value required for each project and may be subject to code approval limitations. On projects where a vapor retarder is used, the specifier must calculate insulation thickness to ensure the temperature at the vapor retarder will not fall below the calculated dew point.
2. Multiple layers of insulation are recommended with all joints staggered between layers.
3. For minimum recommended R-Values, previously published by American Society of Heating and Air-Conditioning Engineers (ASHRAE), consult local building code official for applicable requirements.
4. For insulation fastening pattern and densities refer to Versico Applicable Details and [Design Reference DR-05 "Insulation Fastening Patterns"](#).
5. Versico Insulation/underlayment must be specified for all Total System Warranty projects or when the insulation is to be covered by the Versico Warranty. Any of the Versico Insulation/Underlayment may be specified subject to design restrictions included with each table.

B. Versico Polyisocyanurate

Table B1 Polyisocyanurate (See below for product descriptions)					
Insulations / Underlayment	Minimum Thickness	ASTM	Roofing System Acceptability		
			Adhered	Mechanically Attached	Ballasted
Versico VersiCore Polyiso, Versico VersiCore Eco	*1.5"	C1289, Type II, Class 1, Grade 2 or 3	√	√	√
Versico VersiCore NH Polyiso	*1.5"	C1289, Type II, Class 1, Grade 2 or 3	√	√	√
SecurShield Polyisocyanurate, SecurShield Eco	*1.5"	C1289, Type II Class 2, Grade 2 or 3	√	√	√
SecurShield NH Polyisocyanurate	*1.5"	C1289, Type II Class 2, Grade 2 or 3	√	√	√
SecurShield HD Polyiso Composite (SS HD)	2"	C1289, Type IV, Grade 2 or 3	√	√	√
DuraFaceR Polyiso Composite (OSB)	1.5"	C1289, Type V, Grade 2 or 3	√	√	N/A
Design Restrictions					
<ul style="list-style-type: none"> - Extended Warranty, those with longer duration, higher wind speed, or puncture coverage, may require the use of a cover board over Polyiso Insulation, refer to Warranty Tables in Paragraph 1.04 for applicable requirements. - Maximum Flute Spanability shall be limited to 2-5/8" when 1" Minimum Polyiso Insulation is to be used. - Minimum thickness of insulation board may be restricted by wind speed coverage and warranty duration, refer to Tables V and VI in Paragraph 1.05. - The use of HD Polyiso Composite roof insulation is not recommended for Ballasted Applications. <p>*1.5" minimum for adhered systems. 1" minimum for mechanically fastened systems or as a base layer for adhered.</p>					
Notes: N/A = Not Acceptable √ = Acceptable					

SecurShield HD is listed in Paragraph F4 below.

1. **Versico VersiCore Polyiso** – A foam core insulation board covered on both sides with a medium weight fiber-reinforced felt facer meeting, ASTM C 1289-06, Type II, Class 1, Grade 2 (20 psi) or Grade 3 (25 psi). The product is available in 4' x 8' standard size with a thickness from 1 to 4 inches. 4' x 4' tapered panels are also available.
2. **Versico VersiCore Eco** - A rigid roof insulation panel with 5% ISCC-certified bio-attributed content composed of a closed-cell polyisocyanurate foam core bonded to glass-reinforced felt (GRF) facers, meeting ASTM C 1289, Type II, Class 1, Grade 2 (20 psi) or Grade 3 (25 psi). The product is available in 4' x 8' standard size with a thickness from 1 to 4 inches. 4' x 4' tapered panels are also available. UL and FM approved for direct application over steel decks, polyiso provides the highest R-value per inch of any commercially available insulation product.
3. **Versico VersiCore NH Polyiso** – A foam core insulation board covered on both sides with a glass-reinforced felt meeting ASTM C 1289, Type II, Class 1, Grade 2 (20 psi) or Grade 3 (25 psi). The product is available in 4' x 4' and 4' x 8' standard size with a thickness from ½" to 4 inches. VersiCore NH Polyiso contains zero halogenated flame retardants.
4. **SecurShield Polyisocyanurate**- A foam core insulation board covered on both sides with a coated glass fiber mat facer meeting ASTM C 1289-06, Type II, Class 2 (20 psi) or Grade 3 (25 psi). The product is available in 4' x 8' standard size with a thickness from 1 to 4 inches. 4' x 4' tapered panels are also available. These flat board products feature a dark-colored coated-glass facer (CGF) on one side of the insulation board and a light-colored CGF on the other, labeled Ready Flash. Ready Flash Technology allows applicators to manage adhesive flash-off times by choosing between two different-colored facers on every board.
5. **SecurShield Eco** – A rigid roof insulation panel with 5% ISCC-certified bio-attributed content composed of a closed-cell polyisocyanurate foam core bonded to high performance coated glass facers (CGF). ASTM C 1289, Type II, Class 2, Grade 2 (20 psi) or Grade 3 (25 psi), available in 4' x 8' standard size with a thickness from 1 to 4 inches. 4' x 4' tapered panels are also available. Ideal for use in adhered membrane systems. Achieves a UL Class A fire rating direct to combustible deck.
6. **SecureShield NH Polyisocyanurate** - A foam core insulation board covered on both sides with a coated glass fiber mat facer meeting ASTM C 1289, Type II, Class 2, Grade 2 (20 psi) or Grade 3 (25 psi). The product is available in 4' x 4' and 4' x 8' standard size with a thickness from ½ inch to 4 inches. SecurShield NH contains zero halogenated flame retardants.
7. **SecurShield HD Composite** – Composite insulation panel comprised of 1/2 inch high-density (109 psi max) Polyiso cover board laminated during the manufacturing process to SecurShield rigid Polyiso roof insulation meeting ASTM C1289 Type IV, Grade 2 (20 psi) or Grade 3 (25 psi). Available in 4' x 8' boards with a thickness from 2" to 4.5". 4' x 4' panels are also available.
8. **DuraFaceR Polyiso Composite (OSB)** – Polyiso insulation bonded on the bottom side with a medium weight fiber reinforced felt facer and laminated with a top surface of 7/16" or 5/8" thick Oriented Strand Board (OSB) meeting ASTM C 1289-06, Type V, Grade 2 (20 psi) or Grade 3 (25 psi). Available in 4' x 8' boards with a thickness from 1-1/2" to 4".

C. EPS : Expanded Polystyrene

Table C1 EPS: Expanded Polystyrene (See below for product descriptions)					
Insulations / Underlayment	Minimum Thickness	ASTM	Roofing System Acceptability		
			Adhered	Mechanically Fastened	Ballasted
InsulFoam I	1"	C578 Type I	N/A	N/A	√
InsulFoam VIII	.75"	C578 Type VIII	N/A	N/A	√
InsulFoam II	.75"	C578 Type II	N/A	N/A	√
InsulFoam IX	.75"	C578 Type IX	N/A	N/A	√
InsulFoam HD Composite (SecurShield HD)	1.5"	C578 Type (I, VIII, II, or IX)	√	√	N/A
InsulLam (Various Cover Boards)	1.5"	C578 Type (I, VIII, II, or IX)	√	N/A	N/A
InsulFoam SP	1"	C578 Type VIII	N/A	√	√
Design Restrictions					
<ul style="list-style-type: none"> - Local Codes must be consulted regarding the acceptance of expanded insulation directly over steel decks. When specified, minimum thickness shall be designated by the manufacturer. - Expanded polystyrene roof insulations cannot be installed directly over coal-tar pitch roof surfaces or existing PVC membranes. A separation layer of minimum 1/2" SecurShield HD, Versico Recovery Board or Polyiso Insulation shall be used. - The use of InsulFoam HD Composite roof insulation is not recommended for Ballasted Applications. Notes: N/A = Not Acceptable √ = Acceptable					

R-Tech Fanfold Recover Board is listed in Paragraph C4 below.

1. **InsulFoam I** - A closed-cell lightweight expanded polystyrene (EPS) that meets ASTM C578, Type I. Nominal density of 1.0 lbs/cubic ft. (pcf) available in 4' x 4' or 4' x 8' sizes with thickness from 1/4" to 40". Custom lengths, widths and tapered boards are available. May be specified beneath Versico HP Recovery Board, DensDeck Prime, DensDeck StormX Prime, Securock or DEXcell.
2. **InsulFoam VIII** – A closed-cell lightweight expanded polystyrene (EPS) that meets ASTM C578, Type VIII. Nominal density of 1.25 lbs/cubic ft. (pcf) available in 4' x 4' or 4' x 8' sizes with thickness from 1/4" to 40". Custom lengths, widths and tapered boards are available. May be specified beneath Versico Recovery Board, DensDeck Prime, DensDeck StormX Prime, Securock or DEXcell.
3. **InsulFoam II** – A closed-cell lightweight expanded polystyrene (EPS) that meets ASTM C578, Type II. Nominal density of 1.5 lbs/cubic ft. (pcf) available. May be specified beneath Recovery Board, DensDeck Prime, DensDeck StormX Prime, Securock or DEXcell.
4. **InsulFoam IX** – A closed-cell lightweight expanded polystyrene (EPS) that meets ASTM C578, Type IX, Nominal density of 2.0 lbs/cubic ft. (pcf) available in 4' x 4' or 4' x 8' sizes with thickness from 1/4" to 40". Custom lengths, widths and tapered boards are available. May be specified beneath Recovery Board, DensDeck Prime, DensDeck StormX Prime, Securock or DEXcell.
5. **InsulFoam HD Composite-** InsulFoam expanded polystyrene (EPS) insulation laminated with a top surface of 1/2" thick SecurShield HD. Available in 4' x 8' boards with thickness from 1-1/2" to 7".
6. **InsulLam** – InsulFoam expanded polystyrene (EPS) insulation laminated with a top surface of 7/16" or 5/8" thick Oriented Strand Board (OSB), 1/2" Securock, 1/2" DEXcell or 1/2" Versico Recovery Board. Available in 4' x 8' boards with thickness from 1-1/2" to 7".
7. **InsulFoam SP** – A closed-cell lightweight expanded polystyrene (EPS) with a factory-laminated fiber glass facer. Nominal density of 1.25 lbs/cubic ft. (pcf), and meets ASTM C578, Type VIII. Designed for low-sloped roof applications that employ mechanically attached or ballasted membranes.

- D. **XPS: Extruded Polystyrene** – Available through Versico is dimensionally stable with high thermal and low water absorption performance capability. XPS is available in varying compressive strengths thicknesses and sizes. Refer to specific Technical Data Bulletins for physical properties and additional technical information.

Table D1 XPS: Extruded Polystyrene (See below for product descriptions)					
Insulations / Underlayment	Minimum Thickness	ASTM	Roofing System Acceptability		
			Fully Adhered	Mechanically Attached	Ballasted
Thermapink 18	.75"	Refer to Technical Data Bulletin	N/A	N/A	√
Thermapink 25	1"	Refer to Technical Data Bulletin	N/A	N/A	√
Foamular 400	1"	Refer to Technical Data Bulletin	N/A	N/A	√
Dow Styrofoam Deckmate Plus	1"	Refer to Technical Data Bulletin	N/A	N/A	√
Design Restrictions					
<ul style="list-style-type: none"> - Local Codes must be consulted regarding the acceptance of expanded insulation directly over steel decks. When specified, minimum thickness shall be designated by the manufacturer. - Expanded polystyrene roof insulations cannot be installed directly over coal-tar pitch roof surfaces or existing PVC membranes. A separation layer of minimum 1/2" SecurShield HD, Versico Recovery Board or Polyiso Insulation shall be used. - Refer to related products listed in Spec Supplement P-01 "Related Products" for other products which may be suitable for use. Versico must be contacted for specific requirements. 					
Notes: N/A = Not Acceptable √ = Acceptable					

2. **Thermapink 18 or 25 Extruded Polystyrene**
3. **Foamular 400 Extruded Polystyrene**
4. **Dow Styrofoam Deckmate Plus Extruded Polystyrene**

E. **Versico Vacuum Insulated Panel (VIP)**

Table E1 Vacuum Insulated Panel (VIP) (See below for product descriptions)				
Insulations / Underlayment	Minimum Thickness	ASTM	Roofing System Acceptability	
			Adhered	Mechanically Attached
Versico OPTIM-R® VIP	*1.6"	C1484	√	N/A
ADVANC-R® VIP	0.94"	C1484	√	N/A
Design Restrictions				
*2.6" minimum for total installed system including an additional 2 layers of 1/2" SecurShield HD panels; 1 layer on top and 1 layer on bottom of OPTIM-R®. For adhered systems only.				
Note: OPTIM-R® VIP & ADVANC-R® VIP cannot be cut or punctured.				
Notes: N/A = Not Acceptable √ = Acceptable				

1. **OPTIM-R® Vacuum Insulated Panel (VIP)** – a high R-Value vacuum insulated panel (VIP) used to provide a low-profile solution when height restrictions exist, such as windows, doors, equipment curbs, etc. Provides an R-38 insulating value in a 2.6" system thickness with up to 35% infill (non-VIP material). Available in 23.6" x 23.6" and 23.6" x 47.2" board sizes.
2. **ADVANC-R® VIP** – a thin, rigid, high R-value, non-structural vacuum insulated panel. Provides a low-profile solution for height restricted roof conditions such as penthouse doors, windowsills, equipment curbs and parapet walls. Provides a R-66 insulating value in a 0.94" thick panel. Available in 22.4" x 24.0" and 22.4" x 48.0" panel sizes.

F. Cover Boards/Slip Sheets

Table F1 Cover Boards (See below for product descriptions)					
Insulations / Underlayment	Minimum Thickness	ASTM	Roofing System Acceptability		
			Adhered	Mechanically Attached	Ballasted
SecurShield HD, SecurShield HD Eco	.5"	C1289, Type II, Class 4 (109 psi max)	√	√	N/A(2)
SecurShield HD Plus	.5"	C1289, Type II, Class 4 (109 psi max)	√	√	N/A(2)
VersiCore HD, VersiCore HD Eco	.5"	C1289, Type II, Class 1, Grade 3	N/A	√	N/A
DuraStorm VSH	.5"	Refer to Technical Data Bulletin	√	√	N/A
Securock Roof Board	.25"	C1177	√	√	N/A
Securock Glass-Mat Roof Board	.25"	C1177	N/A	√	N/A
Securock UltraLight Glass-Mat Roof Board	.25"	C1177	N/A	√	N/A
Securock UltraLight Coated Glass-Mat Roof Board	.25"	C1177	√	√	N/A
Versico Recovery Board	.5"	C208 Grade 2	√	√	√
DensDeck StormX Prime	.625"	C1177	√	√ (1)	N/A
DensDeck Prime	.25"	C1177	√	√ (1)	N/A
DensDeck	.25"	C1177	N/A	√ (1)	N/A
R-Tech Fanfold Recovery Board	.5"	C578 Type (I, VIII, II. or IX)	N/A	√	√
HP Protection Mat	6 oz	Refer to Technical Data Bulletins	N/A	√	√
DEXcell® Glass Mat	.25"	C1177	N/A	√	N/A
DEXcell FA™ Glass Mat	.25"	C1177	√	√	N/A
DEXcell® Cement Roof Board	.4375"	C1325	√	√	N/A
DEXcell FA VSH®	.625"	C1177	√	√ (1)	N/A
Design Restrictions					
<p>- Versico Recovery Board and R-Tech Fanfold not recommended for direct use over Type B and F steel decks.</p> <p>- Securock Roof Board, Recovery Board, DensDeck Prime, DensDeck StormX Prime, DEXcell or DensDeck may not be used directly over New or Existing Lightweight Insulating Concrete Decks existing or Structural Concrete.</p> <p>- Due to some warranty restrictions, DensDeck, DensDeck Prime, DensDeck StormX Prime and DEXcell are not recommended for use directly over existing roofing membrane without prior written approval from Versico. Contact Versico for specific requirements.</p> <p>- R-Tech Fanfold primarily for use in existing roof re-covers applications or directly over structural or lightweight insulating concrete.</p> <p>- HP Protection Mat may be used for Ballasted systems over Lightweight Insulating Concrete with a Maximum Warranty duration of up to 15 years. To be used for Mechanically Attached on new construction projects with Lightweight Insulating Concrete, Fiber Cement or Gypsum Deck a Maximum Warranty duration of up to 15 years.</p> <p>(1) Permitted with roofs with slopes greater than 2" per foot for compliance with external fire codes, refer to UL listings or contact Versico.</p> <p>(2) Acceptable for some roof system designs. Contact Versico for Recommendations</p> <p>Notes: N/A = Not Acceptable √ = Acceptable</p>					

1. **SecurShield HD** – A rigid insulation panel composed of a high-density (109 psi max), closed-cell polyisocyanurate foam core laminated to coated-glass fiber-mat facer, meeting ASTM C1289, Type II, Class 4, Grade 1, for use as a cover board or recover board. Available 1/2" thick 4' x 8' panel weight 11 lbs with an R-value of 2.5.

Features Ready Flash, a dark-colored coated-glass facer (CGF) on one side of the insulation board and a light-colored CGF on the other. Ready Flash Technology allows applicators to manage adhesive flash-off times by choosing between two different-colored facers on every board.

2. **SecurShield HD Eco** – A rigid roof insulation panel with 5% ISCC-certified bio-attributed content composed of ½" high-density, closed-cell polyisocyanurate foam core bonded to a premium performance coated glass facer (CGF) specifically designed for use as a cover board, meeting ASTM C1289, Type II, Class 4, Grade 1. Provides 5 times the R-value at one-fifth the weight of traditional gypsum cover boards. Achieves a UL Class A fire rating direct to combustible deck. Available in 1/2" thick, 4' x 4' (5.5 lbs) and 4' x 8' (11 lbs) panels with an R-value of 2.5.
3. **SecurShield HD Plus** – A rigid insulation panel composed of a high-density (109 psi max), closed-cell polyisocyanurate foam core laminated to premium-performance coated-glass fiber-mat facer, meeting ASTM C1289, Type II, Class 4, Grade 1, for use as a cover board or recover board. Available 1/2" thick 4' x 8' panel weight 11 lbs with an R-value of 2.5. Meets an FM 1-90 using only 8 fasteners per 4' x 8' board.
4. **VersiCore HD** – a closed-cell polyisocyanurate foam core insulation board covered on both sides with glass-reinforced felt (GRF) facer meeting ASTM C 1289, Type II, Class 1, Grade 3. The product is available in 4' x 4' and 4' x 8' standard sizes with a thickness of one-half inch.
5. **VersiCore HD Eco** - A rigid-roof insulation cover board with 5% ISCC-certified bio-attributed content composed of a high-density closed-cell polyisocyanurate foam core bonded on each side to glass-reinforced felt (GRF), meeting ASTM C1289, Type II, Class 1, Grade 3. UL and FM approved for direct application over steel decks. Available in 1/2" thick, 4' x 4' and 4' x 8' panels with an R-value of 2.5.. Suitable for both re-roofing and new construction applications, InsulBase HD is specifically designed for use as a cover board in mechanically-attached single-ply systems only. InsulBase HD delivers an R-value of 2.5.
6. **Securock Roof Board** – A uniform composition of fiber-reinforced gypsum, without a facer, for use as a cover board or a thermal barrier in mechanically fastened and fully adhered roofing systems. Meets ASTM E84 for flame spread and smoke development; Class A fire performance per UL 790. Available in 1/4" to 5/8" thick and 4' x 4' or 4' x 8' size boards. 5/8" meets requirements of Type X per ASTM C1177. Long uninterrupted runs (>200') may require slight gapping due to thermal expansion.
7. **Securock Glass-Mat Roof Board** – A fire-resistant, moisture and mold-resistant roof board used in mechanically fastened, low-slope roofing systems, featuring a specially treated core and high-performance glass-mat facer. Meets ASTM E84 for flame spread and smoke development; Class A fire performance per UL 790. Available in 1/4", 1/2" and 5/8" and 4' x 8' size boards. 5/8" meets requirements of Type X per ASTM C1177.
8. **Securock UltraLight Glass-Mat Roof Board** – A fire-resistant, moisture and mold-resistant roof board used in mechanically fastened, low-slope roofing systems, featuring a specially treated lightweight core and high-performance glass-mat facer. Meets ASTM E84 for flame spread and smoke development; Class A fire performance per UL 790. Available in 4' x 8' size boards; 1/4", 1/2" and 5/8" thicknesses available. 5/8" meets requirements of Type X per ASTM C1177.
9. **Securock UltraLight Coated Glass-Mat Roof Board** - A fire-resistant, moisture and mold-resistant roof board used in fully adhered, low-slope roofing systems, featuring a specially treated lightweight core. The special coating on the high-performance glass-mat facer provides an exceptional adhesive bond and reduces facer delamination. Meets ASTM E84 for flame spread and smoke development; Class A fire performance per UL 790. Available in 1/4", 1/2" and 5/8" and 4' x 8' size boards. 5/8" meets requirements of Type X per ASTM C1177.
10. **DuraStorm VSH Cover Board** – an engineered composite building material made from a proprietary blend of plastic and cellulose fiber sourced from post-industrial and post-consumer waste streams. DuraStorm VSH is a durable, extremely moisture and mold resistant building material with a core that does not disintegrate or delaminate in the presence of water. Available in 1/2" thick and 4' x 8' size board.
11. **Versico Recovery Board** – A 1/2" or 1" thick high-density wood fiberboard with an asphalt coated facer for use as a cover board or recover board. Available 1/2" or 1" thick and 4' x 4' or 4' x 8' size boards. When used in reroof / no tear-off projects, warranty is limited to 15-year projects.
12. **DensDeck StormX Prime** – a reinforced gypsum cover board with an enhanced, moisture-resistant core and coated glass mat facers on the top and bottom side. The top surface is pre-primed and provides excellent bond strength for adhered membrane for use as a cover board. DensDeck StormX Prime is extremely durable and is approved for use in assemblies meeting FM's Very Severe Hail (VSH) Classification. Available in 5/8" thickness and 4' x 4' or 4' x 8' size boards.

13. **DensDeck Prime** – Gypsum core that incorporates glass-mat facings on the top and bottom side. The top surface is pre-primed and provides excellent bond strength for fully adhered membrane for use as a cover board. Available in 1/4" to 5/8" and 4' x 4' or 4' x 8' size boards.
14. **DensDeck Cover Board** – Gypsum core that incorporates glass-mat facings on the top and bottom side for use as a cover board. Available in 1/4" to 5/8" and 4' x 4' or 4' x 8' size boards.
15. **R-Tech FanFold Recover Board** – Closed-cell lightweight expanded polystyrene (EPS) with polymeric laminated faces which meets ASTM C578 for use as a recover board. Polymeric facer compatible with PVC membrane, while metallic side used with EPDM. Available in thicknesses of 3/8" to 3/4" with coverage 4' x 50' (2 squared). 4' x 8' units are also available.
16. **HP Protection Mat** – A nominal 6-oz per square yard UV resistant polypropylene needle punched fabric used either above the membrane as a slip-sheet for ballast or an underlayment to the membrane. Available 15' x 300' roll (4500 square foot) weighing 0.06 lbs per square foot.
17. **DEXcell® Glass Mat**– A mold & mildew resistant, gypsum substrate board with coated fiberglass facers, used for thermal protection and acoustical enhancement of roof systems. May be used as a substrate for a vapor retarder and/or the continuous substrate for the application of commercial roofing applications. Available in 1/4", 1/2" and 5/8" thicknesses in 4' x 8' boards.
18. **DEXcell FA™ Glass Mat**– A mold & mildew resistant, gypsum substrate board with heavy duty, coated fiberglass facers, used for thermal protection and acoustical enhancement of roof systems. May be used as a substrate for a vapor retarder and /or the continuous substrate for the application of commercial roofing applications. The pre-coated, fiberglass facers are designed to increase adhesive coverage and enhance performance of the bond strength of the system. Available in 1/4", 1/2" and 5/8" thicknesses in 4' x 4' and 4' x 8' boards.
19. **DEXcell® Cement Roof Board** – A mold & mildew resistant, Portland Cement, lightweight aggregate roof board with heavy-duty fiberglass mesh facers used as a substrate board, thermal barrier and cover board for commercial roofing applications. Available in 7/16" and 5/8" thicknesses in 4' x 4' and 4' x 8' boards.
20. **DEXcell FA VSH®** – A reinforced gypsum panel with enhanced moisture resistant gypsum core and heavy duty coated glass facers used as a substrate board, thermal barrier and cover board for commercial roofing applications, approved for use in single-ply and multi-ply assemblies meeting FM Very Severe Hail rating. Available in 5/8" thickness in 4' x 4' and 4' x 8' boards.

2.04 Related Materials

A. Flashing

1. **VersiGard Black/VersiGard White or VersiGard Gray Quick-Applied Cured Cover Strip:** A 6" and 9" widths and 100' long and 12" wide by 50' long VersiGard Black or VersiGard White or VersiGard Gray 60-mil cured EPDM membrane laminated to a nominal 30-mil cured Quick-Applied Tape. The Cured Cover Strip is ideal for flashing gravel stops, metal edging and Versico Seam Fastening Plates.
2. **VersiGard Quick-Applied Overlayment Strip:** A nominal 40-mil black, **semi-cured** EPDM membrane laminated to a nominal 30-mil cured, Quick-Applied Tape. Available in 6" and 9" widths and 100' long and 12" width with 50' long rolls used to overlay seams, flash gravel stops, metal edgings and Seam Fastening Plates used for additional membrane securement.
3. **VersiGard (black) / VersiGard White (white) or VersiGard Gray Quick-Applied Uncured Flashing:** A 6" x 100' and 9" or 12" wide by 50' long, 60-mil thick VersiGard (black), VersiGard White (white on black) or VersiGard (gray) **uncured** EPDM Flashing laminated to a 30-mil Quick-Applied Tape used in conjunction with EPDM Primer.

VersiGard/VersiGard White or VersiGard Gray Quick-Applied Uncured Flashing is used to flash inside and outside corners, pipes, scuppers and field fabricated pourable sealer pockets when the use of Versico pre-fabricated flashing accessories is not feasible.

4. **VersiGard/VersiGard White or VersiGard Gray Quick-Applied Curb Flashing** – A 20" wide by 50' long VersiGard Black or cured 60-mil thick EPDM membrane with 6" wide Quick-Applied Tape along one edge to be used to flash curbs/skylights, etc.

5. **VersiGard/VersiGard White or VersiGard Gray 20" Peel & Stick EPDM Cured Flashing** – A 20" wide by 50' long VersiGard Black, VersiGard White or VersiGard Gray cured 60-mil thick EPDM membrane with Quick-Applied TAPE the full width already applied, used to flash curbs/skylights, etc.
6. **VersiGard/VersiGard White or VersiGard Gray Quick-Applied "T" Joint Covers** – A factory cut 6" x 6" or 12" x 12" uncured 60-mil thick EPDM flashing laminated to a nominal 30-mil Quick-Applied Tape, used to overlay field splice intersections and to cover field splices at angle changes. Available in 6" x 6" and 12" x 12" sizes for VersiGard (black) and 6" x 6" sizes for VersiGard White and VersiGard Gray.
7. **VersiGard (black)/VersiGard White or VersiGard Gray Quick-Applied Inside/Outside Corner** – A 7" x 9" precut 60-mil thick (black, gray or white) Uncured Flashing with a 30-mil Quick-Applied Tape; used for inside and outside corners, to overlay field splice intersections, and to cover field splices at angle changes.
8. **VersiGard (black)/VersiGard White or VersiGard Gray Quick-Applied Pipe Seals** with Quick-Applied Tape on the deck flange are available for use with VersiGard/VersiGard White or VersiGard Gray Roofing Systems:
 - a. VersiGard (black) Quick-Applied Pipe Seals are available in sizes: 1/2" to 3" and 1" to 6".
 - b. VersiGard White (white) and VersiGard (gray) Quick-Applied Pipe Seals are available in one size: 1" to 6"
9. **VersiGard/VersiGard White or VersiGard Gray Quick-Applied Pourable Sealer Pocket:** A pre-fabricated Pourable Sealer Pocket which consists of a 2" wide plastic support strip with Quick-Applied, adhesive backed uncured Flashing; black available in 4", 6" and 8" diameters for VersiGard (black) EPDM, 6" diameter for Sure-Seal (gray) and 6" and 8" diameter for VersiGard White (white).

B. SEAM TAPES, PRIMERS, ADHESIVES AND SEALANTS/CLEANERS

Refer to Technical Data Bulletins for material coverage rates and proper usage. Prior to the use of any of the products listed below, consult the Material Safety Data Sheets for applicable cautions and warnings.

1. **VersiGard QA Seam Tape** – A 3" or 6" wide by 100' long Splice Tape used for splicing adjoining sections of EPDM membrane. 6" wide splice tape is used for Mechanically Attached Roofing Systems and 20-year Warranty Systems. Complies with the South Coast Air Quality Management District Rule 1168.
2. **Versico V-150 Primer** – A solvent-based primer used to prepare the surface of EPDM membrane for application of QA Seam Tape or Quick-applied products. Available in 1 gallon pails and pressurized cylinders.
3. **Low-VOC EPDM and TPO Primer** – A Low-VOC (volatile organic compound) primer (less than 250 grams/liter) for priming EPDM or TPO surfaces prior to application of QA Seam Tape or Quick-applied products. Available in 1 gallon pails and in pressurized cylinders.
4. **Versico's Lap Sealant** – A heavy-bodied material used at splice intersections beneath "T"-joint covers, at cut edges of reinforced EPDM membrane and around uncured Quick-applied accessories.
5. **Versico Weathered Membrane Cleaner** – A clear, solvent-based cleaner used to loosen and remove dirt and other contaminants from the surface of exposed EPDM membrane prior to applying Versico EPDM Primer. Available in 1 and 5-gallon pails.
6. **Low-VOC Membrane Cleaner:** A Low-VOC (volatile organic compound) cleaner (100% EPA-exempted solvents) used to loosen and remove dirt and other contaminants from the surface of exposed EPDM membrane prior to applying Versico EPDM Primer. Available in 1 and 5-gallon pails.
7. **G200-SA Yellow Substrate Adhesive** – A high-strength, yellow colored, synthetic rubber adhesive used for bonding VersiGard EPDM membranes to various surfaces.
8. **EPDM x-23 Low-VOC Bonding Adhesive** – A Low-VOC (volatile organic compound) bonding adhesive (less than 250 grams/liter) used for binding VersiGard/VersiGard White EPDM membranes to various surfaces. Adhesive is available in 5 gallon pails.
9. **Aqua Base 120 Bonding Adhesive:** A semi-pressure-sensitive water based adhesive; used as a 2-sided contact adhesive for bonding VersiGard EPDM membrane to various surfaces. Complies with the South Coast Air Quality Management District Rule 1168.
10. **CAV-GRIP 3V Low-VOC Adhesive/Primer:** a low-VOC, spray-applied aerosol contact adhesive and primer used for a variety of applications: adhering standard VersiWeld TPO and VersiGard EPDM membranes to horizontal and vertical surfaces, adhering VersiFleece membranes to vertical surfaces, as a primer for VapAir Seal 725TR, and as an unexposed asphalt primer for Flexible DASH for insulation attachment.

11. **G500 CM Water Cut-Off Mastic** – A one-component, low viscosity, self-wetting, butyl blend mastic used as a sealing agent between the EPDM membrane and applicable substrates.
12. **G-400 Pourable Sealer** – A black, two-component, solvent-free, polyurethane based product used for tie-ins and as a sealant around hard-to-flash membrane penetrating objects such as clusters of pipes and for daily seal when the completion of flashings and terminations cannot be completed by the end of each work day.
13. **One-Part Pourable Sealer** – A black, one-component, moisture curing, elastomeric polyether sealant used for attaching lightning rod bases and ground cable clips to the membrane surface and as a sealant around hard-to-flash penetrations such as clusters of pipes.
14. **Universal Single-Ply Sealant** – A one-part polyether, non-sagging sealant designed for sealing expansion joints, control joints and counter flashings. Available in white and gray.

2.05 Fastening Components

A. Termination STRIPS (RTS)

1. **VersiGard Quick-Applied RTS (Reinforced Termination Strip):** A 6" or 9" wide, nominal 45-mil thick clean, cured reinforced EPDM black membrane with 3" wide Quick-Applied Tape laminated along one edge for the 6" wide RTS and along both edges for the 9" wide RTS.
 - a. **6" wide Quick-Applied RTS** is used horizontally or vertically at the base of walls, curbs, etc., in conjunction with Fastening Plates or Bars below the EPDM deck membrane for additional membrane securement.
 - b. **9" wide Quick-Applied RTS** is utilized for perimeter membrane securement on VersiGard mechanically attached roofing systems and primary securement on Metal Retrofit Roofing Systems.
2. **VersiGard White Quick-Applied RTS (Reinforced Termination Strip)** – A 6" wide, nominal 45-mil thick clean, cured, reinforced EPDM membrane with 3" wide Quick-Applied Tape laminated along one edge. Used on VersiGard white fully adhered roofing systems.

B. Fasteners

The following Table illustrates criteria for fastening of Versico Insulation with the referenced roof deck and include minimum penetration requirements and pilot hole criteria.

Deck Type	Versico Fasteners (1)	Min. Penetration	Pilot Hole Depth	Pilot Hole Diameter
Steel or Lightweight Insulating Concrete over Steel	HPV, HPVX, ASAP or InsulTite™	3/4"	N/A	N/A
Structural Concrete, rated 3,000 psi or greater	CD-10	1"	Note (2)	7/32"
	MP 14-10	1"	Note (2)	3/16"
Wood Plank, min. 15/32" thick Plywood or min. 7/16" OSB	HPV, ASAP or InsulTite	Min. 1" (3)	N/A	N/A
Cementitious Wood Fiber	Polymer Gyptec	1-1/2"	Note (4)	N/A
Cementitious Wood Fiber	Lite-Deck Fastener	2"	Note (4)	N/A
Gypsum	Polymer Gyptec	1-1/2"	Note (2)	7/16", 1/2" or 9/16" (5)
Gypsum	Lite-Deck Fastener	2"	Note (5)	Note (6)

Notes: N/A = Not Applicable

- (1) Only 3" diameter insulation fastening plates can be used for insulation attachment.
- (2) The pilot hole must be predrilled to a sufficient depth to prevent contact between the fastener point and any accumulated dust in the predrilled hole. This will help prevent bottoming out of the fastener during installation.
- (3) For wood planks only, fastener penetration shall not exceed 1-1/2".
- (4) Most cementitious wood fiber decks do not require pre-drilling; however, Versico should be contacted prior to installation for verification of specific types that may require a pilot hole to be predrilled.
- (5) Pilot hole size may be varied to maximize pullout resistance.
- (6) Gypsum hardness varies, and the desired pullout may determine pilot hole size. This could range from 1/4" to 5/16".

All VersiGard Fasteners listed below can be used with VersiGard (black and white) Roofing Systems. Refer to the applicable specification for specific requirements.

1. **HPV Fastener** – A threaded E-coat square head fastener for insulation and reinforced membrane attachment (mechanically attached systems) in conjunction with 2" diameter Polymer Seam Plates. Used into steel, wood plank, minimum 15/32" thick plywood or minimum 7/16" thick oriented strand board (OSB).
2. **HPVX Fastener** - A high-performance fastener with an oversized, heavy shank with #15 thread diameter for single-ply membrane or insulation attachment, used to secure steel decks (20- [0.91 mm] or 22-gauge [0.76 mm]) or wood, minimum 15/32" thick CDX plywood).
3. **HPV-XL Fastener** – An oversized diameter (.315") steel, threaded fastener used in conjunction with HPV-XL Polymer Seam Plates for membrane securement into minimum 22-gauge steel or wood decks on mechanically attached roofing systems.
4. **InsulTite ASAP** – Versico's InsulTite Fastener pre-assembled with a 3" diameter plate used for insulation attachment only on fully adhered and mechanically attached roofing systems.
5. **InsulTite Fasteners** – A threaded Philips drive fastener used with Versico Insulation Plates for insulation attachment to steel or wood decks.
6. **MP 14-10 Concrete Fastener** – A #14 threaded fastener with a #3 Philips driver used for minimum 3,000 psi concrete decks.
7. **CD-10 Nail-In Fastener** – A hammer-driven, non-threaded E-Coat Fastener for use with structural concrete decks rated 3,000 psi or greater.
8. **Polymer Gyptec Fastener** – A non-penetrating, plastic fastener and corresponding plate used with lightweight deck substrates such as fibrous cement and gypsum.
9. **Term Bar Nail-In** – A 1-1/4" long expansion anchor with threaded drive pin used for fastening VersiGard Termination Bar or Seam Fastening Plates to concrete, brick or block walls. The fastener is set by hammering the drive pin into place.
10. **Lite-Deck Fastener:** A deep, coarse threaded fastener used to secure insulation to gypsum and cementitious wood fiber decks in conjunction with Lite-Deck Plates.

C. Fastening Plates and Bars

1. **Polymer Seam Plate** – A 2" diameter plastic barbed fastening plate used with Versico HPV Fasteners for membrane and Quick-Applied RTS securement for mechanically attached roofing systems over steel roof decks.
2. **HPV-XL Plate** – A 2-3/8" diameter plastic barbed listening plate used with HPV-XL Fasteners for membrane and Quick -Applied RTS securement for mechanically attached roofing systems over steel roof decks.
3. **Seam Fastening Plates** – A 2" diameter metal plate used for insulation attachment on mechanically attached roofing systems or membrane securement on fully adhered roofing systems in conjunction with the appropriate Versico Fastener.
4. **Insulation Fastening Plates** – A nominal 3" diameter metal plate used for insulation attachment in conjunction with the appropriate Versico Fastener.
5. **SecurFast Insulation Fastening Plates:** A nominal 2-7/8" hexagon metal plate used for insulation attachment in conjunction with the appropriate Versico Fastener.
6. **Accutrac Insulation Plates:** A nominal 3" square, recessed or flat bottomed, metal plate used for insulation attachment in conjunction with the appropriate Versico Fastener. Flat bottom plate is used with manufactured Philips Head fasteners only.
7. **Gyptec Plates** – A 3" (26-gauge) steel plate for insulation and a 2" (22 gauge) steel plate for membrane attachment. The plates are stamped Galvalume-coated steel.
8. **Polymer Batten Strip** – A 1" wide by 1/20" thick polymer bar which is pre-punched 6" o.c. packaged in 250' long coils used for membrane securement on mechanically attached roofing system in conjunction with HPV or HPVX Fasteners. Refer to applicable Technical Data Bulletin.

9. **Metal Fastening Bar** – A 1" wide metal bar which is pre-punched 6" o.c. and packaged in 10' long strips to be used for membrane securement on mechanically attached roofing systems.

2.06 Insulation Securement Adhesive

1. **Flexible DASH Adhesive** – A spray (full coverage) or bead-applied, two-component polyurethane, construction grade, low-rise expanding foam adhesive used for attaching approved insulations to compatible roof decks or existing smooth or gravel surfaced BUR, modified bitumen or cap sheets. Available in 50 gallon and 15 gallon drums.
2. **Flexible DASH Dual Tank:** A two component (Part A and B), extrusion applied, low rise adhesive for bonding insulation to various surfaces. Flexible DASH Dual Tanks utilize an HFO blowing agent. HFO (hydrofluoroolefin) blowing agents are widely recognized as the next-generation environmentally friendly blowing agent, replacing their HFC (hydrofluorocarbon) predecessor. When extruded at 12" on center the coverage rate is 3,500 to 3,700 sq.ft. per set of Dual Tanks.
3. **Flexible DASH Dual Cartridge and 5-gallon Jug Adhesive:** A two component (Part A and B), extrusion applied, low rise adhesive for bonding insulation to various surfaces. When extruded at 12" on center the coverage rate is 400-600 sq.ft. per carton of Dual Cartridges or 2,000-2,500 sq.ft. per set of 5-gallon Jug Adhesive.
4. **OlyBond 500™ Bag in a Box** – A two-component, polyurethane, low-rise expanding adhesive used to bond insulation to various substrates. Packaged in 5-gallon boxes of Part A and Part B formulations that are applied using a mechanical dispense system. Applied in 1/2" to 3/4" beads or ribbons at the rate of 1 gallon per 150-250 square feet for 12" o.c. bead spacing. Perimeter bead spacing patterns and acceptable insulation and deck types are listed in the applicable Technical Data Bulletin.
5. **OlyBond 500 BA Spot Shot** – A two-component, polyurethane construction grade, low-rising expanding adhesive designed for bonding insulation to various substrates. Applied in 1/2" to 3/4" beads or ribbons using a portable 1:1 applicator (oversized, dual-cartridge caulking gun). Refer to the Technical Data Bulletin for bead spacing with reference to building height.

2.07 Vapor/Air Barrier

A. General

The use of a vapor retarder to protect insulation and reduce moisture accumulation within an insulated roofing assembly should be investigated by the specifier, especially on projects with high interior humidity, such as, swimming pools, breweries, pulp mills, etc.

If insulation is to be fully adhered to the vapor retarder with Flexible DASH Adhesive, the vapor retarder must be compatible and shall be fully adhered to the substrate. Available products include Versico's VapAir Seal 725TR Air and Vapor Barrier, VapAir Seal MD Air and vapor Barrier and spray or roller applied Butyl coatings. Installation requirements for Versico's VapAir Seal 725TR Air and Vapor Barrier are identified in [Spec Supplement G-07 "Application Procedures for 725TR Air and Vapor Barrier"](#) and Versico's VapAir Seal MD Air and Vapor Barrier are identified in [Spec Supplement G-12 "Application Procedures for Versico's VapAir Seal MD Air and Barrier"](#) in the Versico Technical Manual.

1. **Versico 725TR Temporary Roof Air and Vapor Barrier** – A 40-mil thick composite consisting of 35-mil self-adhering rubberized asphalt membrane laminated to a 5-mil UV resistant poly film with an anti-skid surface which is fully compatible with Flexible DASH Adhesive. 725TR can also function as a temporary roof for up to 120 days. Available in rolls 39" wide by 100' long (325 square feet).
2. **Versico VapAir Seal MD Air and Vapor Barrier** – a reinforced composite aluminum foil with self-adhesive SBS backing and removable poly release film. Used for direct application over metal decks. Available in rolls 42.5" wide by 131.23" long (460 square feet).
3. **CAV-GRIP 3V Low-VOC Adhesive/Primer:** a low-VOC, spray-applied aerosol contact adhesive and primer used for a variety of applications: adhering standard VersiWeld TPO and VersiGard EPDM membranes to horizontal and vertical surfaces, adhering VersiFleece membranes to vertical surfaces, as a primer for VapAir Seal 725TR, and as an unexposed asphalt primer for Flexible DASH for insulation attachment.
4. **CCW-702 Primer and 702LV Primer (Low-VOC)** - A single component, solvent based, high-tack primer used to provide maximum adhesion between Versico 725TR Air and Vapor Barrier and an approved substrate. Applied by spray or long nap roller with a coverage rating ranging from approximately 300 to 350 square feet per gallon on smooth finishes (i.e., concrete) to 75 square feet per gallon on porous surfaces (i.e., DensDeck

Prime gypsum board). Available in 5-gallon containers. CCW-702LV Primer contains less than 250g/L VOCs and meets South Coast Air Quality Management District (SCAQMD) and Leadership in Energy and Environmental Design (LEED) Requirements for Volatile Organic Compounds.

5. **CCW-702WB** – a high-tack, water-based contact adhesive for promoting adhesion of Versico air/vapor barrier membranes and an approved substrate (i.e., concrete, DensDeck Prime and Securock). Applied by roller, brush or spray with an application rate of approximately 200 sq. ft. per gallon. Available in 5-gallon containers. CCW-702WB Primer contains 57g/L VOCs and meets South Coast Air Quality Management District (SCAQMD) and Leadership in Energy and Environmental Design (LEED) Requirements for Volatile Organic Compounds.

2.08 Edges And Terminations

A. General

Products listed below can be used with any of the available Versico Roofing Systems. Refer to the applicable Versico details and installation instruction manuals for specific installation criteria.

B. Products

1. Fascia Products

- a. **VersiTrim Snap-on Fascia:** A two-part snap-on assembly including a base plate and decorative snap-on cover. Includes a 20-gauge retainer base plate with pre-slotted holes for fasteners. **The fascia is available in 0.040" or .050" aluminum with mill-finish, anodized-finish or Kynar® 500 finish or 22- or 24-gauge galvanized steel with Kynar® 500 finish or acrylic coated galvalume finish.** Available in a variety of standard colors. Custom colors are available upon request. Available in sizes from 3-1/2" to 12-1/4" face heights. ANSI/SPRI/FM-4435 ES-1 certified.
- b. **VersiTrim One Fascia:** A snap-on edge system consisting of a 20-gauge galvanized steel formed rail with pre-punched slots, a 6" stainless steel spring clip. corrosion resistant fasteners with a 24 gauge galvanized steel or 0.040", 0.050" or 0.063" Kynar® finished aluminum fascia cover. Available in a variety of standard colors. Custom colors are available upon request. Available in 12' standard lengths with face sizes of 4", 5", 6" and 8". ANSI/SPRI/FM-4435 ES-1 certified.
- c. **VersiTrim Snap-On Canted Fascia:** A snap-on edge system consisting of a 24-gauge galvanized metal water dam with pre-punched holes, a 24-gauge stainless steel spring clip and a snap-on cover. The cover is available in 0.040", 0.050" or 0.063" thick mill-finish, anodized, or Kynar® 500 finish aluminum or 22- or 24-gauge steel with Kynar® 500 finish. The fascia is available in a variety of standard colors. Custom colors are available upon request. Available in 12' standard lengths and heights varying from 5" to 12-1/2". ANSI/SPRI/FM-4435 ES-1 certified.
- d. **VersiTrim Crimp-On Canted Fascia:** A crimp-on edge system featuring a 24-gauge, galvanized metal water dam with pre-punched holes, a 24-gauge stainless steel spring clip and a snap-on cover. The fascia cover is available in 0.040", 0.050" or 0.063" thick mill-finish, anodized, or Kynar® 500 finish aluminum or 22- or 24-gauge steel with Kynar® 500 finish. The fascia is available in a variety of standard colors. Custom colors are available upon request. Available in 12' standard lengths and heights varying from 5-1/4" to 12-3/4". ANSI/SPRI/FM-4435 ES-1 certified.
- e. **VersiTrim EX Snap-On Fascia:** An anchor bar roof edge fascia system consisting of heavy 0.100" thick extruded aluminum bar, corrosion resistant stainless-steel fasteners and snap-on fascia cover used with Adhered, Mechanically Fastened assemblies. The fascia cover is available in 0.040", 0.050" or 0.063" thick mill-finish, anodized, or Kynar® 500 finish aluminum or 22- or 24-gauge steel with Kynar® 500 finish. The fascia is available in a variety of standard colors. Custom colors are available upon request. Available in 12' standard lengths and 4", 5-1/2", 7" and 8-1/2" heights. ANSI/SPRI/FM-4435 ES-1 certified.

2. Coping Products

- a. **VersiTrim Gold Coping:** A snap-on coping system that incorporates 20-gauge, galvanized steel anchor clips and 12", 20-gauge, factory-applied stainless-steel springs. Available with 22- and 24-gauge steel with Kynar® 500 finish or 0.040", 0.050" and 0.063" mill-finish, anodized or Kynar® 500 coated aluminum. A variety of standard colors are available. Custom colors are available upon request. ANSI/SPRI/FM-4435 ES-1 Certified.
- b. **VersiTrim Snap-on Coping:** A snap-on coping system that incorporates 20-gauge, galvanized steel anchor cleats with pre-slotted holes, a concealed joint cover and 0.040", 0.050" and 0.063" thick mill-finish,

anodized or Kynar® 500 finish or 22- or 24-gauge Kynar 500® coated steel. The coping cap is available in a variety of colors and widths, including custom pieces such as tees, crosses, and radius copings. Custom colors are available upon request. Available in standard 12' lengths with 6" to 16" wall heights. ANSI/SPRI/FM-4435 ES-1 certified.

Also available in **VersiTrim CF Gold Coping** with 16-gauge anchor cleats for added performance.

- c. **VersiTrim One Coping:** A mechanically fastened coping system consisting of a 22-gauge retainer bar (face side only), corrosion resistant fasteners and a .040", .050" or .063" mill-finish, anodized or Kynar® 500 coated aluminum and 22- or 24-gauge, Kynar® 500 coated steel coping cover. A variety of standard colors are available. Custom colors are available upon request. Available for wall thicknesses up to 12". ANSI/SPRI/FM-4435 ES-1 Certified.
- d. **VersiTrim Continuous Cleat Coping:** An engineered coping system, featuring continuous, 20-gauge galvanized steel cleats on both the inside and outside face of the parapet. Available with 0.040", 0.050" and 0.063" mill-finish, anodized or Kynar® 500 coated aluminum and 22- and 24-gauge Kynar® 500 coated steel. A variety of standard colors are available. Custom colors are available upon request. Custom fabricated for specific project requirements. Cleat available in standard 12' lengths. ANSI/SPRI/FM 4435/ES-1 Certified. Miami-Dade approved.

3. Water Control Products

- a. **VersiTrim Gravel Stop:** A two-piece assembly that consists of a continuous 22-gauge steel cleat with pre-punched holes and snap-on gravel stop cover. The gravel cover is available in 0.040", 0.050", and 0.063" mill-finish, anodized or Kynar® 500 coated aluminum or 22- and 24-gauge steel with galvanized Kynar® 500 coated or acrylic coated galvalume finish. Available in a variety of standard colors. Custom colors are available upon request. Available in 12' standard lengths with 3" to 10" heights and 1" and 3" flange widths. ANSI/SPRI/FM-4435 ES-1 Certified.
- b. **VersiTrim Drip Edge:** Designed for use on Adhered and Mechanically Fastened Roofing Systems. Includes a 22-gauge continuous 12' pre-punched, 90-degree angle cleat and 10' or 12' long fascia sections, including concealed joint covers. Available in 0.032" or 0.040" mill-finish, anodized or Kynar® 500 coated aluminum or 24-gauge Kynar 500 coated steel. A variety of standard colors are available. Custom colors are available upon request. ANSI/SPRI/FM-4435 ES-1 Certified.
- c. **VersiTrim EX Drip Edge:** Featuring an extruded aluminum anchor bar with pre-punched holes for roof membrane securement. The cover is manufactured from 0.040" aluminum with mill-finish, anodized or Kynar® 500 finish or 24-gauge steel with Kynar® 500 finish. Available in standard 12' lengths with sizes ranging from 3" to 7.5" face heights. A variety of standard colors are available. Custom colors are available upon request. ANSI/SPRI/FM 4435/ES-1 Certified. Miami-Dade approved.
- d. **VersiTrim WR Gutter:** system incorporates 1" wide extruded internal gutter brackets and aluminum or galvanized steel gutter. Available in 0.040", 0.050 or 0.063" aluminum, and 22-gauge or 24-gauge with Kynar® 500 finish. Gutter support brackets are extruded aluminum. Available in box style, chamfer style, and offset profiles. ANSI/SPRI/FM 4435/ES-1 Certified.
- e. **Versico Ballast Retaining Bar** – A ballast retaining perimeter securement system comprised of a slotted (4" on center) extruded mil aluminum retention bar with an integrated compression fastening strip. 1-1/2" stainless steel fasteners with Neoprene washers are provided for stable securement.
- f. **Termination Bar** – A 1" wide and 98-mil thick extruded aluminum bar pre-punched 6" on center which incorporates a sealant ledge to support Lap Sealant and provide increased stability for membrane terminations.
- g. **SureTite Snap-On Fascia Cleat:** Prefabricated, 22-gauge, Galvalume steel, continuous, snap-on cleat with pre-punched holes. Used for use on single ply roofing applications when Versico metal flat sheets are used to shop fabricate the fascia or coping cover. Available in 12' standard lengths and 4-1/4" to 8-1/4" face heights. ES-1 certified.
- h. **SureTite Drip Edge Cleat:** Prefabricated, 22-gauge, Galvalume steel, continuous, cleat with pre-punched holes. Used for use on single ply roofing applications when Versico metal flat sheets are used to shop fabricate the drip edge, gravel stop or flat coping cover. Available in 12' standard lengths and 3", 5" 6" and 7" heights. ES-1 certified.

- 4. Refer to [Spec Supplement P-01 "Related Products"](#) for other edgings and coping materials.

2.09 Roof Walkways

Walkways are to be specified at all traffic concentration points (i.e., roof hatches, access doors, rooftop ladders, etc.), and if regular maintenance, once a month or more, is necessary to service rooftop equipment.

1. Walkway Types:

- a. **Versico (White, Gray or Black) Pressure-Sensitive Molded Walkway Pads:** Versico molded walkway pads with factory applied Quick-Applied Tape are used to provide protection for areas of EPDM membrane that are exposed to regular rooftop maintenance.
- b. **Versico Interlocking Rubber Pavers:** 24" x 24" x 2" thick rubber paver weighing approximately 24 pounds per unit, 6 pounds per square foot manufactured from recycled rubber, which provides a resilient, shock absorbing, weather resistant surface. Designed primarily for use as a walkway or on terrace areas offering a unique, environmentally sound advantage over concrete pavers. Features include freeze/thaw stability, bi-directional drainage and no breakage concerns. Available in black and terra cotta.
- c. **Hanover Ballast and Lightweight Ballast Pavers:** The standard, 24" x 24" x 1-13/16" thick, Ballast Paver comes in a natural color and a non-slip Diamond finish and weighs 22 lbs/sq. ft. The Lightweight, 23-1/2" x 23-1/2" x 1-1/4" thick, Ballast Paver comes in a natural color and a non-slip diamond finish and weighs 15 lbs/sq. ft. Both pavers can be used as ballast or walkways.

2.10 Other Versico Accessories

Refer to [Spec Supplement P-01 "Related Products"](#) for additional accessories.

Part III- Execution

Prior to commencing with the installation of any of the EPDM Membrane Systems refer to Paragraph 1.05 "Warranty Tables" for applicable components and proper securement method suitable for the appropriate warranty coverage.

Requirements listed in this specification are considered minimum and are intended for the sole purpose of obtaining a Versico Warranty. Additional requirements dictated by Regulatory Agencies, Building Insurance or Specifiers must be complied with and are considered to be beyond the scope of this specification.

3.01 General

- A. Safety Data Sheets (SDS) must be on location at all times during transportation, storage and application of materials. The contractor shall follow all safety regulations as recommended by OSHA and other agencies having jurisdiction.
- B. Subject to project conditions, it is recommended to begin the application of this roofing system at the highest point of the project area and work to the lowest point to prevent water infiltration. This will include completion of all flashings, terminations and daily seals.
- C. A proper substrate shall be provided by the building owner. This structure shall be sufficient to withstand normal construction loads and live loads.

3.02 Roof Deck/Substrate Criteria

- A. Proper decking shall be provided by the building owner. The building owner or their designated representative must ensure that the building structure is investigated by a registered engineer to assure its ability to withstand the total weight of the specified roofing system, as well as construction loads and live loads, in accordance with all applicable codes. The specifier must also designate the maximum allowable weight and location for material loading and storage on the roof.
- B. When insulation is mechanically fastened to the roof deck, withdrawal resistance tests are strongly suggested to determine the suitability of the roof deck. Refer to [Design Reference DR-06 "Withdrawal Resistance Criteria"](#) in the Versico Technical Manual proper procedures for conducting pullout tests.
- C. Defects in the substrate surface must be reported and documented to the specifier, general contractor and building owner for assessment. The Versico Authorized Roofing Contractor shall not proceed with installation unless defects are corrected.
- D. On structural concrete decks, when a vapor retarder is not used, gaps in the deck along the perimeter and around penetrations must be sealed along with vertical joints between tilt-up panels, if present, to prevent infiltration of hot humid air and possible moisture contamination resulting from condensation. This is specifically important when polyurethane adhesive is used to attach the roof insulation.
- E. **For all projects** (new or retrofit), the substrate must be relatively even without noticeable high spots or depressions. Accumulated water, ice or snow must be removed to prevent the absorption of moisture in the new roofing components and roofing system.
- F. Prior to the placement of membrane underlayment, clear the substrate of debris and foreign material that may be harmful to the roofing system. Gaps greater than 1/4" must be filled with an appropriate material.
- G. For direct application over an acceptable roof deck/substrate or when HP Protective Mat is specified and approved by Versico as the membrane underlayment in accordance with the Roof Deck and Substrate Criteria Table, the substrate must be smooth, steel trowel finished (structural concrete), free of debris, protrusions, sharp edges and loose and foreign material. Cracks or voids in the substrate, greater than 1/4", must be filled with an appropriate material.
- H. **On retrofit - recover projects**, cut and remove wet insulation, as identified by the specifier, and fill all voids with new insulation of type specified so it is relatively flush (+/- 1/4") with the existing surface.
 - 1. Entrapment of water between the old and new membrane can damage and deteriorate new insulation/underlayment between the two membranes. **If a vapor retarder or air barrier is not specified**, Versico recommends the existing membrane be perforated to avoid potential moisture accumulation and to allow the detection of moisture to enable the building owner to take corrective action. This can be accomplished by drilling approximately 3/4" diameter holes every 100 square feet in the existing built-up roof or single-ply membrane (excluding PVC membrane).

2. **For existing PVC membranes**, if the membrane is not removed, it must be cut into maximum 10' by 10' sections. All PVC flashings at the perimeter, roof drains and roof penetrations must be removed.
 3. When installing this roofing system over an existing **gravel surfaced built-up roof**, **loose gravel must be removed**. Power brooming is recommended by Versico to remove the loose gravel, which may trap moisture. Any uneven areas of the substrate must be leveled to prevent insulation from bridging.
 4. On retrofit projects, all existing phenolic insulation must be removed.
 5. Refer to table below for other Recover/Retro-fit considerations
- I. The following table identifies the **acceptable roof decks/substrates** and the **minimum underlayment** requirements for Versico's EPDM Roofing Systems.

Note: Refer to the Warranty Tables, Paragraph 1.05, of this specification, for the minimum underlayment requirements for a specific Warranty Coverage.

Roof Deck & Substrate Criteria

Certain warranty restrictions apply for projects with warranties greater than 15 YR. Refer to Table V 'Re-roofing Substrate Criteria' for warranty limitations in paragraph 1.05.

Acceptable Roof Deck/Substrate	EPDM Membrane		
NEW CONSTRUCTION	Fully Adhered - Design "A"	Ballasted - Design "B"	Mechanically Attached
Steel (min. 22 gauge)(1)(2)	Insulation	Insulation	Insulation
Structural Concrete (min. 3000 psi)	Direct Application (11)	Insulation	HP Protective Mat (10)
Plywood (min. 15/32" thick) or Oriented Strand Board (min. 7/16" thick)	Direct Application (11)	Insulation	Direct Application (11)
Wood Planks (minimum 3/4" thick)	Direct Application	Insulation	Direct Application (11)
Fibrous Cement	Insulation	Insulation	HP Protective Mat
Lightweight Insulating Concrete	Note 3 (10)	Protective Mat (10)	Direct Application (10)
RETROFIT / NO TEAR-OFF	Fully Adhered - Design "A"	Ballasted - Design "B"	Mechanically Attached
Existing Smooth Surface BUR or Mineral Surface Cap Sheet	Direct Application (4)(11)	Insulation	Direct Application (4)(11)
Gravel Surfaced BUR (5)	Insulation	Insulation	Insulation
Coal Tar Pitch (5)(6)	Insulation (9)	Insulation	Insulation
Modified Bitumen	Direct Application (8)(11)	Insulation	Direct Application (8)(11)
Existing Single-Ply	Insulation	Insulation (7)	Direct Application (7)(11)
Sprayed-in-place Urethane	Complete Tear-off Required	Insulation	Complete Tear-off Required
RETROFIT / TEAR-OFF	Fully Adhered - Design "A"	Ballasted - Design "B"	Mechanically Attached
Existing roof material removed (regardless of deck type)	Insulation	Insulation	Insulation

Notes:

- (1) Local codes must be consulted regarding thermal barrier requirements.
- (2) Mechanically Attached Systems cannot be specified on steel decks less than 22 gauge or for corrugated steel decks, regardless of gauge.
- (3) The Design "A" Fully Adhered Roofing System may be specified directly over a new approved cellular or perlite lightweight insulating concrete substrate with a minimum compressive strength of 225 psi. Except when the lightweight insulating concrete is poured over slotted steel decks, pressure relief vents must be specified at a minimum rate of 1 every 2000 square feet. Direct Application is not permitted where the lightweight concrete is poured over an existing roofing material. Refer to [Spec Supplement G-03 "Fully Adhered Application Over Lightweight Insulating Concrete"](#).

(4) VersiGard Black Fully Adhered and Mechanically Attached Systems may be applied directly to the substrate provided asphalt on existing smooth surfaced built-up roof has a softening point above 185°F (85°C). VersiGard White Roofing Systems are not recommended for direct application to the substrate due to possible staining of the membrane surface. For direct application over smooth BUR or granule surface BUR or in conjunction with HP Mat make sure substrate is clean and free of roofing cement and fresh asphalt to avoid sheet contamination and staining of white color membrane.

(5) Loose gravel must be removed to avoid entrapment moisture.

(6) Existing coal tar could drip back into the building, especially when new insulation does not provide sufficient thermal value to prevent the surface of the coal tar from softening.

(7) An approved Insulation/underlayment is required over existing ballasted single-ply systems and PVC roofing systems of any type.

(8) Direct application permitted over smooth surfaced modified bitumen. Membrane shall be positioned with length of sheets parallel to modified bitumen field seams. At end laps or other locations where EPDM splices intersect modified bitumen field seams, 6" wide Uncured or Quick- Applied Flashing must be applied over intersections.

(9) If insulation is specified to be secured to an existing coal tar pitch roof with Versico Flexible DASH Adhesive or hot asphalt, minimum 1.5" thick Polyisocyanurate insulation is the required minimum thickness when VersiGard Black EPDM is specified. Minimum 1" thick Polyisocyanurate is the required minimum thickness when VersiGard White EPDM is specified.

(10) For direct application. Membrane system warranties are limited to 15 YR unless specifically approved by Versico.

(11) Maximum warranty available is 20 YR with 55 MPH peak gust wind speed coverage (72 MPH peak gust wind speed coverage over structural concrete, wood planks or plywood) peak gust wind speed coverage. Versico may be contacted for other options.

J. Vapor Retarder Installation

For Versico's Vapor Retarder refer to [Spec Supplement G-07 "Application Procedures for 725TR Temporary Roof Air and Vapor Barrier"](#). Follow the respective vapor retarder manufacturer's recommended installation procedures and the specifier's instructions for the installation of the product specified. When insulation is to be set in adhesive, verify compatibility with Versico when Vapor Retarder by others is specified.

K. Wood Nailers

1. Install wood nailers in locations that have been designated by the specifier and as approved by Versico. Refer to [Design Reference DR-08 "Wood Nailers and Securement Criteria"](#) for Wood Nailer Criteria.
2. Wood nailers are not covered by the Versico Warranty.

3.03 Insulation/Underlayment

A. General

1. Roof insulation thickness must be determined by the thermal value required for each project and may be subject to code approval limitations. On projects where a vapor retarder is used, the specifier must calculate insulation thickness to ensure the temperature at the vapor retarder will not fall below the dew point.
2. For new construction projects in cold climate regions, the use of vapor retarders or air barriers is strongly recommended to protect insulation from moisture generated during construction.
3. Multiple layers of insulation are recommended with all joints staggered between layers.
4. Do not install more insulation/underlayment than can be covered by membrane in the same day.
5. All insulation boards must be butted together with no gaps greater than 1/4". Gaps greater than 1/4" are not acceptable.
6. Restrictions:
 - a. Versico Roofing Systems cannot be specified in conjunction with Phenolic Insulation.
 - b. Fiberglass insulation cannot be specified with Versico's Design "A" Fully Adhered and Mechanically Attached Roofing Systems, even if overlaid with additional insulation or membrane underlayment.
 - c. Do not specify perlite boards directly under the EPDM membrane on Design "A" Fully Adhered or Mechanically Attached Roofing Systems.
 - d. Wood fiberboard manufactured by others is not an acceptable underlayment for use with Design "A" Fully Adhered Roofing Systems unless approved in writing by Versico prior to installation.
 - e. For all EPDM Roofing Assemblies, the use of insulation by others is not acceptable when a Versico Membrane System Warranty is specified. Versico insulation must be used.

3.04 Insulation Attachment

A. General

1. Prior to proceeding with insulation securement refer to Warranty Tables, Paragraph 1.05, for attachment method and appropriate fastening density required for the specific Versico Warranty.

B. Fully Adhered Roofing Systems

1. **Mechanical Attachment**, insulation fastening density will vary based on insulation type, thickness, and required warranty. Warranty Tables in Paragraph 1.05 should be referenced for fastening density and the appropriate Versico detail may be consulted to identify acceptable fastening pattern.
 - a. For code compliance, increased fastening density may be required depending upon project wind speed and wind uplift requirement. Refer to [Design Reference DR-05 "Insulation Fastening Patterns"](#) for fastening pattern reference.
 - b. When insulation securement is to comply with Factory Mutual (FM) approvals, follow the requirements of the specifier concerning additional securement at the roof perimeter and corners. Also refer to [Design Reference DR-05 "Insulation Fastening Patterns"](#) for various fastening patterns.
 - c. On Reroof/No Tear off projects with a maximum roof height of 40', 1/2" SecurShield HD requires 12 fasteners per board. HP Recovery Board and Polyisocyanurate less than 1-1/2" thick require 16 fasteners per board.
 - d. When Oriented strand board (OSB) is specified for membrane underlayment, utilize DuraFaceR OSB/Polyiso Composite, mechanically fastened to the deck at the rate 17 fasteners for 4 x 8 board in accordance with Versico Details. When positioning OSB, butt edges and stagger joints of adjacent panels.
2. **Adhesive attachment**, Versico Urethane Adhesive Full Spray (Flexible DASH) or Bead (Flexible DASH or Olybond) may be used. When bead adhesive is specified bead spacing will vary based on Warranty coverage, refer to Warranty Tables, Paragraph 1.05 and appropriate Versico Details. CAUTION: Apply adhesive bead so that the distance from the edge of the board does not exceed half the bead spacing (i.e. within 6" of bead spacing of 12" O.C.).

CAUTION: Do not apply urethane adhesives directly to un-weathered asphalt, (new or residual)

CAUTION: Especially in cold regions on tear-off projects or new construction gaps between horizontal and vertical surfaces of the roof area as well as gaps around penetrations must be sealed to prevent interior warm air from infiltrating and condensing within the roofing assembly. Condensing moisture could weaken bottom insulation facer and eventually result in dislodgement or loose boards when adhesive is used.

- a. On FM Global insured projects, consult FM Global's local representative concerning the use of adhesive to attach insulation to steel decks.
- b. Check to ensure the substrate is dry. Adhesive cannot be applied to a wet or damp surface.
- c. Apply Adhesive over the dry substrate area at the coverage rates indicated in [Spec Supplement G-02 "VersiFleece Membrane and Insulation Attachment with Flexible DASH Adhesive"](#).
- d. Allow the adhesive to rise up approximately 1/8" to 3/4", depending on dispensing method, and develop strings prior to setting insulation boards into adhesive.

NOTE: String-time is measured by touching the adhesive with a splice wipe and looking for development of "strings" of adhesive as you pull the splice wipe out of the adhesive. With Flexible DASH Adhesive, string time is generally around 1-1/2 – 2 minutes after application at room temperature.

- e. **Walk the boards into the adhesive and roll using the 30" wide, 150 pound segmented steel roller** to ensure full embedment. Optimal set up time should be approximately 5 to 7 minutes.

CAUTION: Walking on the boards immediately after placement in adhesive can cause slippage/movement until the adhesive has started to set up.

CAUTION: If the boards easily slide, string time has not been achieved.

On roofs with a slope greater than 1/2" in 12", begin adhering insulation at the low point and work upward to avoid slippage.

One person should be designated to walk/roll in all boards. Relief cuts may be necessary to allow lifted board to lay flat, or constant weight (a minimum 10 lbs for 5-15 minutes per lifted area) may be necessary to achieve adequate adhesion.

3. **Alternate attachment method**, the specifier may select an alternate insulation attachment that incorporates a solid mopping of the insulation with hot asphalt (ASTM D312, Type III or IV). If the attachment method is to be covered by the Versico Warranty, Versico must be contacted for specific requirements. Upon review and acceptance by Versico, the maximum warranty coverage available is limited to 20 Year with maximum Peak Gust Wind Speed Coverage of 72 mph.
 - a. Extruded or Expanded Polystyrene insulation are not acceptable when this alternate attachment method is specified.
 - b. The existing gravel surfaced built-up roof must be scraped to remove all loose gravel. Large blisters that may prevent continuous embedment of insulation must be repaired. The surface of the substrate must also be dry and clear of foreign material.
 - c. On coal tar pitch, when deemed compatible by the specifier, minimum 1.5" Polyisocyanurate is the required membrane underlayment when using VersiGard Black membrane. If VersiGard White membrane is used, minimum 1" thick Polyisocyanurate is required.
 - d. For successful attachment, proper asphalt temperatures must be maintained and the specifier's requirements concerning the installation of a base sheet (where required) and quantity of hot asphalt must be followed.
 - e. The maximum insulation board size shall not exceed 4' X 4'. Trim insulation boards around crickets and saddles to ensure continuous embedment.
 - f. Care must be exercised to prevent contamination of the top surface of the insulation. Asphalt oozing through insulation joints must be wiped from the surface. Contact with fresh asphalt can result in discoloration of the VersiGard White membrane.
 - g. Use of a grid nailer, subdividing the roof in individual sections of 2400 square feet is not required for, but its use is strongly recommended.
 - h. The wood nailers are installed relatively flush with the insulation surface and the membrane is to be fastened with seam fastening plates and Versico HPV fasteners on 12" o.c. For wood nailer installation, refer to [Design Reference DR-08 "Wood Nailers and Securement Criteria"](#).

C. **Ballasted Roofing Systems**

1. Insulation boards shall be loose laid over the substrate.
2. Refer to Roof Deck/Substrate Criteria in Paragraph 3.02 for further information.

NOTE: The use of cover boards, such as SecurShield HD, SecurShield HD Plus, DensDeck, DensDeck Prime, DensDeck StormX Prime, Securock or DEXcell is not permitted in conjunction with Ballasted Assemblies to reduce possible membrane punctures. Hard cover boards do not provide sufficient cushioning beneath the membrane and therefore when the assembly is subjected to traffic, the membrane is subjected to higher point loading resulting in puncture.

D. **Mechanically Attached Roofing System**

1. **Versico Fasteners and Fastening Plates are required for insulation securement.** Refer to Insulation Fastening Criteria Table in Paragraph 2.05, for appropriate fastener and deck penetration. The fastener can be used either 2" diameter VersiGard Seam Fastening Plates or 3" diameter VersiGard Insulation Fastening plate.
2. **Any Versico approved insulation or cover board** shall be mechanically fastened to the roof deck at the minimum rate of **1.25 fasteners and plates per every 8 square feet** (5 fasteners in a 4 x 8 board) for minimum 1-1/2" thick insulation and coverboards. Insulation less than 1-1/2" thick requires the use of 8 fasteners and plates in a 4' x 8' board (1 per 4 square feet).

CAUTION: Versico Polyisocyanurate Insulation with a thickness less than 1.5" installed over an existing roofing membrane without a tear-off must be Mechanically Attached to the roof deck with a minimum of 1 fastener and plate for every 4 square feet or less of insulation.

3. Use of DensDeck, DensDeck Prime, DensDeck StormX Prime or DEXcell® should be limited to assemblies with slopes greater than 2" per foot to ensure compliance with external fire codes, care shall be exercised to ensure Polymer Seam Plates are fully seated.

3.05 Membrane Placement and Securement

A. General

1. **Ensure** that water does not flow beneath any completed sections of the membrane system by completing all flashings, terminations and daily seals by the end of each workday.
2. **Sweep** all loose debris from the substrate.
3. If aesthetics is of concern when VersiGard White EPDM is to be used, protection should be specified to avoid discoloration of the white membrane surface resulting from adhesive residue.
4. Adjoining sheets of EPDM membrane are spliced together using QA Seam Tape and Primer.
5. In addition to the primary membrane securement (Bonding for Fully Adhered, Ballasting for Ballasted Systems and Fastening for Mechanically Attached Assemblies), Additional membrane securement is required at the perimeter of each roof level, roof section, curb, skylight, interior wall, penthouse, etc., at any inside angle change where slope or combined slopes exceed 2" in one horizontal foot, and at other penetrations in accordance with the applicable Versico details. Refer to Paragraph G for additional membrane securement.

B. Membrane Placement

EPDM membrane with factory-applied tape is available in various widths. Prior to unrolling sheets ensure the tape side is properly located so that seams are properly shingled down slope. (Pre-applied QA Seam Tape should always be facing downwards once the sheet is unrolled).

1. **Position** EPDM membrane over the acceptable substrate without stretching. For Mechanically Attached assemblies, ensure the proper number of perimeter sheets are properly positioned along the perimeter of the roof. And field sheets are positioned perpendicular to the steel deck flutes.
2. **Allow** the membrane to relax approximately 1/2 hour prior to splicing (Ballasted systems), bonding (Fully Adhered Systems) or fastening (Mechanically Attached systems).
3. **Place** adjoining membrane sheets in the same manner, overlapping edges appropriately to provide for the minimum splice width (2-1/2" or 5-1/2" depending on warranty duration). It is recommended all splices be shingled to avoid bucking of water.

C. Membrane Securement/Bonding – Fully Adhered Roofing System (G200SA, x-23 LVOC, Low-VOC Bonding Adhesive or Aqua Base 120)

1. **Adhere** EPDM membrane to an acceptable substrate with Versico EPDM bonding adhesive. Comply with Labels, Safety Data Sheet (SDS) and Technical Data Bulletins for installation procedures and use. A contact type adhesive must be applied to both the membrane and the surface to which it is being bonded.
2. On projects at high altitudes (6,000' and above), rapid flash-off (drying) of EPDM Adhesive and Primers will occur due to low atmospheric pressure.
3. **Fold** membrane sheet back so half of the underside of the sheet is exposed. Sheet fold should be smooth without wrinkles or buckles.
4. **Stir** EPDM Adhesive thoroughly scraping the sides and the bottom of the can (minimum 5 minutes stirring is recommended). Bonding surfaces must be dry and clean.

CAUTION: If aesthetics is of concern when VersiGard White EPDM membrane is used, protect the white surface next to the edges of the folded membrane sheet so Adhesive will not discolor the white surface. Do not place Adhesive containers or their lids directly on the white surface of the VersiGard White EPDM membrane.

5. **Apply Bonding** Adhesive evenly, without globs or puddles, with a plastic core medium nap paint roller. A 9"

roller will easily fit into the 5-gallon containers.

Apply contact type bonding adhesive to both the membrane sheet and the substrate to achieve continuous coating of both surfaces at a coverage rate of approximately 120 square feet per gallon per one surface (membrane or substrate) or approximately 60 square feet per gallon per finished surface (includes coverage on both membrane and substrate). **Depending on adhesive used and the substrate type adhesive coverage rate will vary.** Refer to Technical Data Bulletin for the appropriate adhesive for the proper coverage rate.

A mechanical roller dispenser or a mechanical sprayer can be used to apply Bonding Adhesive when the continuous coating and coverage rate noted above are maintained. When used, **the adhesive must be rolled after applying** with a plastic core medium nap paint roller to provide continuous coverage.

CAUTION: Due to solvent flash-off, condensation may form on freshly applied Bonding Adhesive when the ambient temperature is near the dew point. If condensation develops, possible surface contamination may occur and the application of Adhesive must be discontinued. Allow the surface to dry and apply a thin freshener coat at the coverage rate, which is approximately half of the coverage rate stated above to the previously coated surface when conditions allow for continuing.

6. **Allow** adhesive to flash-off until it is tacky but will not string or transfer to a dry finger touch.
7. **Roll** the coated membrane into the coated substrate while avoiding wrinkles.
8. **Brush** down the bonded half of the membrane sheet, immediately after rolling the membrane sheet into the adhesive, **with a soft bristle push broom** to achieve maximum contact.
9. **Fold** back the unbonded half of the membrane sheet and repeat the bonding procedure.

D. **Membrane Securement – Quick-Applied Technology (QA) - VersiGard QA – Option 1**

1. VersiGard QA™ membrane must be allowed to relax and expand reaching the required minimum sheet temperature prior to installing.
2. Minimum temperature requirements for VersiGard QA™ installation are based on substrate and fastening method as follows:
 - i. 20° (-6.7°C) ambient and sheet temperature after relaxation for all approved substrates and fastening methods.
 - ii. Use a temperature gun to ensure the membrane is 20° (6.7°C) prior to installation.
3. Prior to membrane placement, the surface of the insulation or underlayment board must be cleaned of dust and other foreign matter using a fine push broom or blower.
4. **Unroll** membrane and allow to relax for 30 minutes.
5. **Remove** the release liner on one-half of the sheet, starting from the split in the liner at the middle of the sheet. The liner should be removed at an angle to reduce splitting or tearing.
6. **Pull** the membrane onto the substrate at an angle, avoiding wrinkles. When installing VersiGard QA membrane, it is recommended to maintain a large curve (radius) on the leading edge of the membrane. This will help eliminate creases and bubbles that cannot be removed after the sheet is in place.
7. **Broom** the membrane in place, starting from the middle of the 10'-wide sheet and working the outer edge.
8. **Fold** back the remaining half of the sheet and repeat the above process.
9. **After** brooming, roll the membrane with a segmented roller to ensure full contact with the substrate. Roller must weigh at least 50 lbs. (22 kg) per linear foot.
10. To complete seam between two adjoining membrane panels, apply primer to the splice area in conjunction with Versico's Quick-Applied Tape.
11. **Strip-in** end laps with 6" Quick-Applied Overlayment Strip or Quick-Applied Cured Cover Strip.

E. **Membrane Securement – Quick-Applied (QA™) (Application Option 2)**

1. VersiGard QA™ membrane must be allowed to relax and expand reaching the required minimum sheet temperature prior to installing.

2. Minimum temperature requirements for VersiGard QA™ installation are based on substrate and fastening method as follows:
 - i. 20° (-6.7°C) ambient and sheet temperature after relaxation for all approved substrates and fastening methods.
 - ii. Use a temperature gun to ensure the membrane is 20° (6.7°C) prior to installation.
3. Prior to membrane placement, the surface of the insulation or underlayment board must be cleaned of dust and other foreign matter using a fine push broom or blower.
4. **Unroll** membrane and allow to relax for 30 minutes.
5. **Pull** both release liners off simultaneously from underneath the membrane at a low angle, similarly to removing the release film from splice tape.
6. **Push** a broom lengthwise down the middle of the sheet to tack it in place. Continue brooming to push air out from the middle of the sheet towards the edges.
7. After brooming, roll the membrane with a segmented roller to ensure full contact with the substrate. Roller must weigh at least 50 lbs. (22 kg) per linear foot.
8. To complete seam between two adjoining membrane panels, apply primer to the splice area in conjunction with Versico's Quick-Applied Tape.
9. **Strip-in** end laps with 6" Quick-Applied Overlayment Strip or Quick-Applied Cured Cover Strip.

F. **Membrane Securement / Bonding - Adhered Roofing Systems (CAV-GRIP 3V)**

1. **Adhere** EPDM membrane to an acceptable substrate with CAV-GRIP 3V Bonding Adhesive. Comply with Labels, Safety Data Sheet (SDS) and Product Data Sheets for installation procedures and use. Contact type bonding adhesive must be applied to both the membrane and the surface to which it is being bonded.
2. On projects at high altitudes (6,000' and above), rapid flash-off (drying) of Bonding Adhesive and Primers will occur due to low atmospheric pressure.
3. **Fold** membrane sheet back so approximately half of the underside of the sheet is exposed. Sheet fold should be smooth without wrinkles or buckles.
4. **Connect CAV-GRIP 3V Cylinder** with hose and spray gun. Bonding surfaces must be dry and clean.

CAUTION: If aesthetics is of concern when VersiGard White EPDM membrane is used, protect the white surface next to the edges of the folded membrane sheet so Bonding Adhesive will not discolor the white surface. Do not place CAV-GRIP 3V Cylinders directly on the white surface of the VersiGard White EPDM membrane.
5. **Spray apply CAV-GRIP 3V** Bonding Adhesive evenly to both the membrane and substrate with a minimum 2" overlap to ensure 100% coverage. Avoid heavy areas or puddles that can skin over, trap solvent and create a blister. Refer to Product Data Sheets for the appropriate adhesive for the proper coverage rate.

CAUTION: Solvent flash-off can lower surface temperature below the dew point causing moisture to form on the adhesive. Slide your hand across the flashed-off adhesive on the insulation or cover board to ensure moisture has evaporated and the adhesive surface is dry and tacky prior to installing the membrane.
6. **Allow** adhesive to flash-off until it is tacky but will not string or transfer to a dry finger touch.
7. **Roll** the coated membrane into the coated substrate while avoiding wrinkles.
8. **Brush** down the bonded half of the membrane sheet, immediately after rolling the membrane sheet into the adhesive, **with a soft bristle push broom.**
9. **Roll the membrane with a 150 lb weighted segmented steel roller after brooming to achieve maximum contact.**
10. **Fold** back the unbonded half of the membrane sheet and repeat the bonding procedure.

G. Membrane Securement/Ballasting- Ballasted Roofing Systems

1. Ballasting- General

- a. Use of temporary ballast to prevent wind uplift is the responsibility of the Versico Authorized Roofing Contractor. For immediate protection against wind uplift, Versico requires ballast to be installed as each section of the installation is completed.
- b. When using polystyrene insulation directly beneath the membrane, ballast must be applied immediately after membrane installation to prevent potential damage to polystyrene insulation products from excessive heat.
- c. Care must be exercised during application of gravel or pavers. Heavily traveled areas during ballast installation must be protected by placing temporary protection courses to prevent possible damage to the EPDM deck membrane and insulation.

2. Ballast Types/Coverage Rates

- a. The coverage rates listed in this section are considered minimum and are required by Versico for issuance of the standard Versico warranty. Depending on specific project conditions (building height, parapet height and project location), additional ballast may be necessary to provide wind uplift protection. Refer to "Attachment I" at the end of this section for suitable ballast types and coverage rates. **Comply with the specifier's requirements when an additional ballast coverage rate is specified.**
- b. **Rounded Water-Worn Gravel** must be applied over the EPDM membrane at the minimum rate of **1000 pounds per square** and must be evenly distributed to maintain an average of 10 pounds per square foot.

ASTM D 7765 SIZE NUMBER	MINIMUM COVERAGE RATE (pounds per square)	AVERAGE COVERAGE RATE (lbs./sq. ft. continuously distributed)
4 (1-1/2" nominal diameter)	1000	10
3 (2" nominal diameter)	1000	10
2 (2-1/2" nominal diameter)	1300	13
1 (3-1/2" nominal diameter)	1300	13

NOTE: In the field of the roof, some bare spots resulting from installation are permitted; however, they must not exceed 64 square inches and must be limited to no more than 2 per square (100 square feet). No bare spots are permitted in the perimeter area of the roof that is 10' wide.

- c. **Crushed Stone** must be applied in conjunction with Versico HP Protective Mat placed over the EPDM membrane. The crushed stone must be applied at the minimum rate of **1000 pounds per square** and must be evenly distributed to maintain an average of 10 pounds per square foot.
- d. **Smooth Surfaced Individual Concrete Pavers** or **Lightweight Interlocking Concrete Pavers**
 - 1) Lightweight interlocking pavers and individual concrete pavers with a surface other than steel troweled finish must be installed over Versico HP Protective Mat. Contact Versico for verification of acceptable pavers.
 - 2) **Individual Concrete Pavers**, when specified, must be installed loose laid and butted with no gaps greater than 1/2".

NOTE: Do not install pavers heavier than 100 pounds per unit unless approved in writing by Versico.

- 3) **Lightweight Interlocking Concrete Pavers**, when specified, must be installed in accordance with the respective manufacturer's specification and as approved by Versico prior to installation.

3. Ballast Criteria for up to 20 Year Extended Warranty

- a. Refer to installations below for calculating corner/perimeter areas for the noted warranty wind speeds available.

Ballast Requirements for 72 mph Warranty

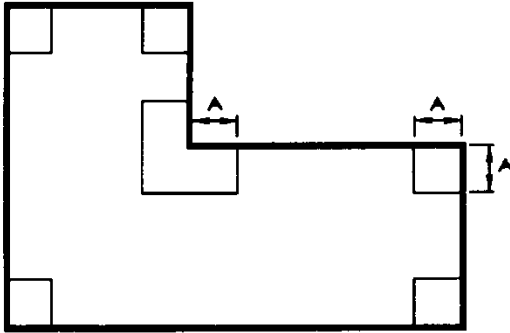

A (Corners) = .4 Times the Building Height
(10' minimum)

Ballast Requirements for 80 mph Warranty

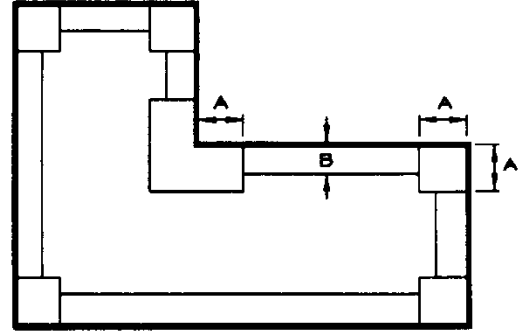

A (Corners) = .4 Times the Building Height
(10' minimum)
B (Perimeters) = 10'

- b. At corner and/or perimeter areas, ballast shall be 2-1/2" nominal rounded water worn gravel conforming to gradation #1 or #2 in accordance with ASTM D7765 method of sizing. Coverage rate shall be a minimum of 13 pounds per square foot.
 - c. In field areas, ballast shall be 1-1/2" nominal rounded water worn gravel conforming to gradation #4 in accordance with ASTM D7765 method of sizing. Coverage rate shall be a minimum of 10 pounds per square foot.
4. Placement of Versico Protective Mat
- a. When specified or required by Versico, position Versico HP Protective Mat loosely over the membrane with all edges overlapped a minimum of 6".
 - b. Extend the mat a minimum of 2" above the anticipated ballast level at the perimeter and around penetrations except for roof drains and scuppers.
 - c. The mat must extend to drain bases, scupper openings and the base of Dutch gutters **but must not restrict drainage**.
 - d. Additional matting must be installed around penetrations to prevent direct contact between crushed stone or pavers and flashing.

Note: Following the placement of the HP Protective Mat, it is necessary to install the ballast or temporary ballast to prevent the movement or displacement of unballasted fabric.

H. Membrane Securement/Mechanically Attached Roofing System (Fastening)

1. EPDM membrane shall be mechanically attached to the structural deck with specified Versico Fasteners and designated Plates or Bars, for fastening densities and numbers of perimeter sheets refer to Warranty Tables, Paragraph 1.05.
2. Membrane Fastening Selection Table

Membrane Fastener Selection

Deck Type	Versico Fasteners*	Versico Plate
Steel or Lightweight Insulating Concrete over Steel	HPV	HPV Polymer or Seam Fastening Plates
	HPV-XL	HPV-XL Polymer
Structural Concrete, rated 3,000 psi or greater	CD-10	HPV Polymer or Seam Fastening Plates
	MP 14-10	HPV Polymer or Seam Fastening Plates
Wood Plank, min. 15/32" thick Plywood or min. 7/16" OSB	HPV	HPV Polymer or Seam Fastening Plates
Cementitious Wood Fiber	Polymer Gyptec	Gyptec Plates – 2" Dia.
Gypsum	Polymer Gyptec	Gyptec Plates – 2" Dia.

Refer to Warranty Tables in Paragraph 1.05 for fastening densities and number of perimeter sheets.

*Determine proper fastener length for deck penetration, refer to Table 2.05B.

3. On steel decks, membrane shall be positioned with seams perpendicular to the steel deck flutes. This allows the external forces on the roof assembly to be distributed between multiple steel deck panels. Refer to [Design Reference DR-06 "Withdrawal Resistance Criteria"](#) in the Versico Technical Manual.
4. When mechanical securement is not provided in some of the Versico Universal Details (i.e., pipes and pourable sealer pockets), additional Seam Fastening Plates must be used for membrane securement. The plates must be positioned a maximum of 12" away from the penetration, spaced a maximum of 12" on center and flashed in accordance with the applicable Versico Detail.
5. **Perimeter Sheets**

The number of perimeter sheets and fastener spacing is dependent on the building height, wind zone location and warranty duration as outlined in Warranty Tables in Paragraph 1.05.

The roof perimeter is defined as all edges of each roof section (i.e., parapets, building expansion joints at adjoining walls, penthouse walls, etc.). When multi-level roofs meet at a common wall, the adjacent edge of the upper roof is treated as a roof perimeter if the difference in height is greater than 10'. Perimeter sheets are not required at the base of the wall at the lower level.

NOTE: Expansion joints, control joints and fire walls in the field of the roof or roof ridges with slopes less than 3" to the horizontal foot are not considered as part of the roof perimeter.

Perimeter sheets can be formed by using individual 5' or 6.5' wide sheets or by sub-dividing 8' or 10' wide field sheet using 9" Quick-Applied RTS strip or row of seam fastening plates as described below.

a. **Individual Perimeter Sheets (5', 6.5')**

Position membrane along the perimeter of the roof over the acceptable insulation/underlayment. The perimeter membrane width from line of securement to line of securement should be approximately 4.5' - 6'-0" wide depending on perimeter sheet size.

b. **RTS (Reinforced Termination Strip) Method**

- 1) When **field sheets are positioned parallel to a roof perimeter, 9" wide Quick-Applied RTS** shall be placed approximately down the center of the 8' or 10' wide field membrane sheets. When a RTS divides a field sheet in half, two perimeter sheets are created.
- 2) When an 8' or 10' wide reinforced **EPDM membrane sheet extends perpendicular to the edge of the roof**, install **9" wide Quick-Applied RTS** beneath the EPDM membrane sheet approximately of 3'-6" for the 8' field sheet to approximately of 4' -0" for the 10' field sheet from the edge of the roof. When multiple perimeter sheets are required, additional RTS may be positioned approximately 3'-6" to 4'-0" from the previous RTS to create additional perimeter sheets.

CAUTION: 6" wide Quick-Applied RTS is only available with 3" wide QA Seam Tape on one side and therefore cannot be used to form perimeter sheets.

3) Refer to Applicable Versico Details for installation

c. **Fastening Plates Method**

When field sheets extend to the edge of the roof, approved fastening plates can be installed through the reinforced membrane 3'-6" to 4'-6" from the roof edge which will be flashed with 6" wide Quick-Applied Cured Cover Strip. When field sheets are positioned parallel to the roof edge, fastening through the membrane along the centerline creates two perimeter sheets. When multiple perimeter sheets are required, additional fastening plates shall be positioned 3'-6" to 4'-6" from the previously installed fastening plates. Refer to applicable Versico Details for installation.

d. **Building with Special Conditions:**

Air pressurized buildings, canopies and buildings with large openings where the total wall openings exceed 10% of the total wall area on which the openings are located (such as airport hangers, warehouses and large maintenance facilities) will typically require additional perimeter membrane securement, an increased fastening density or other enhancement.

e. **Building with large openings**

When any wall contains major openings with a combined area which exceeds 10% of the total wall area on which the openings are located, either four 5' or 6.5' wide to two 10' wide reinforced EPDM membrane sheets (centered over the opening) must be specified as shown.

1) 9" wide Quick-Applied RTS (Reinforced Termination Strip) shall be specified in conjunction with the 8' or 10' wide membrane sheets.

2) The 9" wide Quick-Applied RTS is to be positioned beneath the 8' or 10' wide membrane sheet along the centerline and shall be secured with Polymer Seam Plates (required for steel decks) or Seam Fastening Plates. All fasteners and plates shall be spaced at the rate required at the roof perimeter as shown on the membrane securement charts on the previous pages.

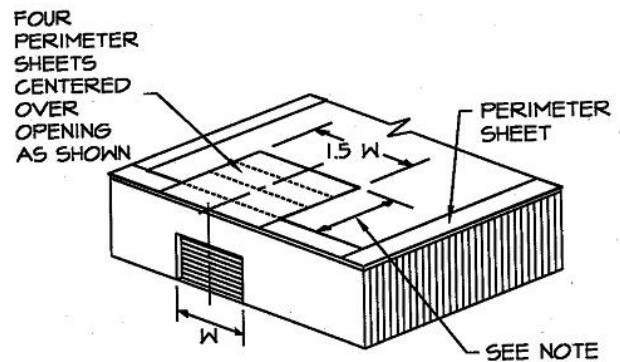

3) As an option to the above perimeter securement, a fully adhered membrane section may be used in lieu of the mechanically attached membrane at large openings in accordance with the Versico Specification for the VersiGard (black and white) Fully Adhered Roofing System.

NOTE: Depth of perimeter area, noted above, shall not be less than 2.5 times the width of the opening.

f. **Buildings with overhangs**

The membrane must be specified with securement 3-1/2' to 4-1/2' over the entire overhang area extending onto the main roof deck a minimum of 3 1/2' when at the same level.

- 1) This can be achieved utilizing 8' or 10' wide membrane sheets in conjunction with 9" wide Quick-Applied RTS as described above.
- 2) As an option, a fully adhered membrane section may be used in lieu of the mechanically attached membrane at building overhangs in accordance with the Versico Specification for the VersiGard (black and white) Fully Adhered Roofing System.

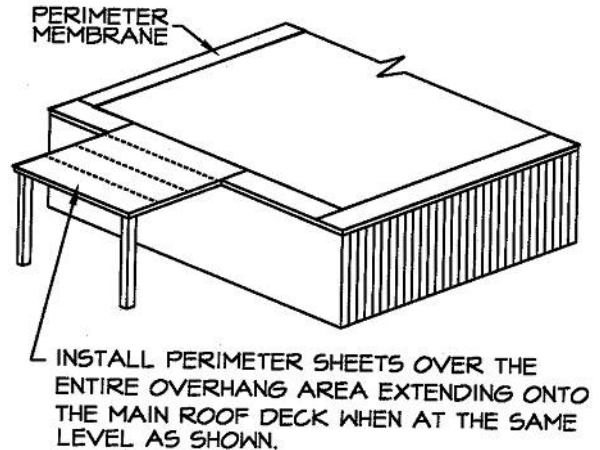

6. **Field Membranes**

- a. **Position** field membrane sheets adjacent to perimeter membrane to allow a minimum 6" overlap, 3" from the center of the plate or bar in front and back.

NOTE: For 20-year warranty projects with a roof slope less than 1/4" in 12" (minimum 1/8" slope required) or when splices buck water, strip in seams with a 6" Quick-Applied Overlayment or Cured Cover Strip.

- b. **Secure the field and perimeter membrane sheets** along the pre-printed blue line approximately 3" from the edge of the membrane sheet at the approved fastening density with the required Versico Fastener and Versico Seam Plates or Bars. Refer to "Membrane Fastener Selection" Table in Paragraph 3.05 for further information.

Correct fastener placement must conform to the following:

- 1) The **minimum** distance between the bottom membrane edge and the nearest edge of the fastening plate or bar must be **2"**.
 - 2) The **minimum** distance between the overlapping membrane edge and the nearest edge of the fastening plate or bar must be **2"**.
- c. On new construction projects, where direct application of the membrane is specified over Protection Mat over lightweight insulating concrete, standard 2" diameter Seam Fastening Plates must be used since the Polymer Seam Plates will not properly seat.
 - d. **Position** adjoining membrane sheets to allow a minimum overlap of 6" where Fastening Plates are located (along length of the membrane); at the same time overlap end roll sections (width of the membrane) a minimum of 3" for Projects with a maximum 15 Year Warranty. For 20 Year Warranties, end roll sections should be overlapped 6" with 6" QA Seam Tape.
 - e. Work shall progress across the roof with a minimum 6" overlap provided at the previously secured sheet edge. The opposite length of the sheet must be secured with approved Fastening Plates or bars and overlapped accordingly.

I. **Membrane Splicing**

1. **General**

a. **VersiGard/VersiGard White – Fully Adhered or Ballasted Roofing Systems**

- 1) **Projects with 10, 15, 20 and 25 year Warranties – [Detail VGC-2.1A.](#)**

Side Laps / End Laps: Tape splices must be a minimum of 2-1/2" wide using **3" wide field-applied Quick-Applied Seam Tape OR 3" Quick-Applied Seam Tape (QAT)**. ([Detail VGC-2.1A](#)).

Splice Intersections: 'T'-Joints are to be flashed with a bead of lap sealant and 6"x6" minimum Quick-Applied 'T'-Joint Cover, (for membranes of maximum thickness of 75 mil). (VGC-2.1A). **For membranes of thickness of 90 mil,** Apply a second layer of 12"x12" Quick-Applied 'T'-Joint Cover centered over 6"x6" 'T'-Joint Cover. ([Detail VGC-2.2A](#)).

Note: A minimum 6"x6" section of Quick-Applied Uncured Flashing may be used as a 'T'-Joint cover. Quick-Applied Uncured Flashing is available in rolls of 6", 9" and 12".

2) **Projects with 30 year warranties – [Detail VGC-2.1A](#)**

OPTION 1:

Side Laps / End Laps: Tape splices may be a minimum **3" wide Factory-Applied QA Seam Tape (VersiGard QAT) OR 3" wide QA Seam Tape**. In addition, the entire field splice must be overlaid with a continuous 6" wide Quick-Applied Overlayment Strip. (See [Detail VGC-2.1A -Option 1](#)).

Splice Intersections: Overlay the entire field splice with a continuous 6" wide Quick-Applied Overlayment Strip. Apply Lap Sealant at all Intersections between Quick-Applied Overlayment Strip. (See [Detail VGC-2.1A -Option 1](#)).

OPTION 2:

Side Laps / End Laps: Tape splices may be a minimum of 5-1/2" wide using **6" wide Factory-Applied QA Seam Tape (VersiGard QAT) OR 6" wide QA Seam Tape**. ([Detail VGC-2.1A – Option 2](#)).

Splice Intersections: 'T'-Joints are to be flashed with a bead of lap sealant and 6"x6" minimum Quick-Applied 'T'-Joint Cover. Apply a second layer of 12"x12" QA 'T'-Joint Cover centered over 6" x 6" QA 'T'-Joint Cover. ([Detail VGC-2.1A – Option](#)).

Note: A minimum 6"x6" section of Quick-Applied Uncured Flashing may be used as a 'T'-Joint cover. Quick-Applied Uncured Flashing is available in rolls of 6", 9" and 12".

b. **VersiGard OR VersiGard WHITE Reinforced Mechanically Attached Roofing System**

1) **Projects with 10, 15, 20 and 25 year Warranties – [Detail VGMA-2.1 and VGMA-2.2](#)**

Side Laps: Regardless of Warranty duration, where fastening plates are placed, shall be spliced using **6" wide Factory-Applied QA Seam Tape (VersiGard QAT) or 6" wide QA Seam Tape**. The splice tape shall be centered over the plates to extend approximately 2" on each side. QA Seam Tape must extend approximately 1/8" beyond the edge of the overlapping membrane. ([Detail VGMA-2.1](#)).

End Laps: Shall be spliced using **3" wide QA Seam Tape** resulting in a minimum splice width of 2-1/2" for a maximum of 20 year warranties. ([Detail VGMA-2.2](#)).

Splice Intersections: 'T'-Joints are to be flashed with a bead of lap sealant and 6"x6" QA 'T'-Joint Cover. ([Detail VGMA-2.1](#)).

2) **Projects with 30 year Warranties – [Detail VGMA-2.2](#)**

Side Laps: Where fastening plates are placed, shall be spliced using **6" wide Factory-Applied QA Seam Tape (QAT) OR 6" wide Field-Applied QA Seam Tape**. The splice tape shall be centered over the plates to extend approximately 2" on each side. QA Seam Tape must extend approximately 1/8" beyond the edge of the overlapping membrane. ([Detail VGMA-2.2](#)).

End Laps: Shall be spliced using **6" wide Factory-Applied QA Seam Tape (QAT) OR 6" wide Field-Applied QA Seam Tape** resulting in a minimum splice of 5-1/2" wide for a maximum of 30 year warranties. ([Detail VGMA-2.2](#)).

Splice Intersections: 'T'-Joints are to be flashed with a bead of lap sealant and 6"x6" QA 'T'-Joint Cover. Apply a second layer of 12"x12" QA 'T'-Joint Cover centered over 6" x 6" QA 'T'-Joint Cover. ([Detail VGMA-2.3](#)).

2. For splicing procedures, cautions and warnings refer to [Spec Supplement E-02 "Membrane Splicing and Splice Repairs"](#) for information.

J. **Additional Membrane Securement**

Securement must be provided at the perimeter of each roof level, roof section, expansion joint, curb flashing, skylight, interior wall, penthouse, etc., at any inside angle change where slope exceeds 2" in one horizontal foot, **and at other penetrations** in accordance with Versico's details and securement options as listed below.

Securement may be achieved as follows:

1. **Quick-Applied RTS (Reinforced Termination Strip)**

Quick-Applied RTS is a 6" wide strip of reinforced EPDM membrane with factory-applied 3" wide QA Seam Tape and is installed in conjunction with Versico EPDM Fasteners and 2" diameter Seam Fastening Plates spaced a maximum of 12" on center below the EPDM deck membrane (Polymer Seam Plates or Polymer Batten Strips are required for Mechanically Attached Roofing Systems over steel decks). The securement strip can be fastened horizontally to the structural deck or vertically at walls and curbs.

- a. Loose lay the 6" wide Quick-Applied RTS along parapet walls 6" to 9" from corners and fasten with Seam Fastening Plates and the appropriate Versico fastener to the roof deck or into the parapet wall. Spacing of the Seam Fastening Plates shall be a maximum of 12" on center for up to 20 year warranties (less than 90 mph warranty wind speed) and a maximum of 6" on center for 25 and 30 year warranties.

- 1) For horizontal attachment, the reinforced strip must be positioned a minimum of 1/8" to a maximum of 6" away from the angle change with pressure sensitive side facing away from the parapet and towards the roof plane.
- 2) For vertical attachment, the reinforced strip must be attached to the vertical wall with pressure sensitive side extending onto the roof surface.

CAUTION: Horizontal RTS attachment is required when insulation is attached with adhesives to a vapor barrier or an existing asphalt based roof. For various options, Refer to [Spec Supplement G-07 "Application Procedures for Versico's VapAir Seal 725TR Air and Vapor Barrier"](#).

- b. Adjoining sections of the reinforced strip need not be overlapped; however, gaps between adjoining sections must not exceed 1".

CAUTION: When RTS is used for membrane securement along metal edgings, refer to the appropriate detail for applicable installation criteria. For some metal edge details, adjoining sections of the reinforced strip must be overlapped and spliced.

- c. **When using Quick-Applied RTS, prime the underside of the field membrane with Versico Primer** and allow proper flash-off prior to mating with the QA tape portion of the RTS.

CAUTION: On fully adhered systems discontinue bonding adhesive application on the underside of the membrane in area of the sheet where contact with the Quick -Applied RTS is to occur. Contact between Quick-Applied RTS and membrane coated with bonding adhesive can result in poor long term peel and shear values.

2. **Seam Fastening Plates**

When the use of Quick-Applied RTS is not feasible (at smaller curbs or skylights), 2" diameter Seam Fastening Plates may be used.

- a. Seam Fastening Plates may be installed horizontally into the structural deck or into walls or curbs.

- b. Securement of the EPDM membrane with the approved Versico Fasteners and Seam Fastening Plates must be a maximum of 12" on center starting 6" minimum to 9" maximum from inside and outside corners.
- c. If horizontal wood nailers are provided, secure the Seam Fastening Plates to the wood nailer with Versico HPV Fasteners. Nails (i.e. ringshank, roofing, etc.) are not acceptable for securement.
- d. After securing the Seam Fastening Plates, flash in accordance with the appropriate Versico Detail.

3.06 Flashings

For other requirements which must be complied with in order for Versico warranty to be issued, refer to [Spec Supplement G-04 "Flashing Considerations / Metal Work"](#).

A. General Considerations

1. All vertical field splices at the base of a wall or curb must be overlaid with Quick-Applied "T" Joint Covers, a 6" x 6" section (with rounded corners) of VersiGard (black and white) Quick-Applied Uncured EPDM Flashing centered over the field splice.
2. **Quick-Applied Uncured EPDM Flashing** must be limited to the overlayment of vertical seams (as required at angle changes), or to flash inside/outside corners, vent pipes, scuppers and other unusually shaped penetrations where the use of Pre-molded Pipe Seals, cured EPDM membrane or Quick-Applied Cured Cover Strip or Overlayment Strip is not practical.

NOTE: When using Quick-Applied products in colder temperatures, use a heat gun to warm the product. Apply heat to the EPDM flashing side of the product. Do not apply heat directly to the pre-applied adhesive. The Quick-Applied Flashing must be applied immediately after primer flashes off. Refer to "Membrane Splicing with QA Seam Tape" for application procedures in colder temperatures.

3. When using **Quick-Applied Cured Cover Strip or Overlayment Strip** to overlay Seam Fastening Plates or metal edging, etc., **V-150 Primer or LOW-VOC Primer** must be used to clean the membrane and metal flanges.
4. Special requirements may apply for certain flashing details for projects with extended warranty durations. Refer to Versico published details for applicable requirements when warranty coverage exceeds beyond 20 years.
5. When using Solvent-Free EPDM Bonding Adhesive refer to the Technical Data Bulletin for additional installation information.

B. Walls, Parapets, Curbs, Skylights, etc.

1. Use continuous deck membrane with Quick-Applied RTS or Seam Fastening Plates along the angle change.
 - a. When using Quick-Applied RTS, refer to Paragraph 3.05 G, Additional Membrane Securement, for attachment criteria.
 - b. When Seam Fastening Plates are used to secure continuous deck membrane, use minimum 6" wide Quick-Applied Cured Cover Strip or Overlayment Strip to overlay fasteners and plates.

2. When the use of continuous deck membrane for wall flashing is not feasible, a separate piece of cured EPDM membrane may be used.

NOTE: 60-mil cured non reinforced membrane may be used as a separate wall flashing with projects of warranty 20 years or greater. The flashing may also incorporate membrane equal of thickness to that of the EPDM membrane at the deck level

3. Adhere flashing to the wall and terminate in accordance with the applicable Versico Detail.
4. Use a "T" Joint Cover or 6" x 6" Quick-Applied Uncured Flashing with rounded corners to overlay vertical splices as shown on the applicable Versico Detail.
5. Refer to applicable Versico Details for various corner flashing options.

C. Flashing of other Penetrations, refer to [Spec Supplement G-04 for Flashing](#) Considerations and the applicable Versico detail for specific requirements.

D. Flashing of Difficult Penetrations, refer to [Spec Supplement G-11 for "LIQUISEAL Liquid Flashing"](#) for

additional information and specific requirements.

3.07 Roof Walkways

Walkways are to be specified at all traffic concentration points (i.e., roof hatches, access doors, rooftop ladders, etc.), and if regular maintenance (once a month or more) is necessary to service rooftop equipment. Refer to [Spec Supplement G-05 “Roof Walkway Installations.”](#)

3.08 Daily Seal

On phased roofing, when the completion of flashings and terminations is not possible by the end of each workday, provisions must be taken to temporarily close the membrane to prevent water infiltration. Refer to Spec Supplement G-06-20 “Daily Seal & Clean Up”.

3.09 Optional Color Coating

1. **If optional color coating is specified, Versico's final inspection for warranty must be conducted prior to the coating application.** This will permit the completion of any “Repair for Warranty” items without consideration for the removal and reapplication of the coating. The owner will then verify that the coating was applied after receiving the warranty.
2. If **X-Tenda Coat** is specified to color the membrane surface, refer to the Versico X-Tenda Coat Specification for installation requirements.

3.10 Clean Up

For daily tie-off or cleaning procedures refer to [Spec Supplement, G-06 “Daily Seal / Clean Up”](#) in the Versico Technical Manual.

A. General

1. Termination bars and surface mounted reglets must be specified to be installed directly to the wall surface.
2. Versico recommends VersiTrim Metal Edging/Coping, Termination Bar or Drip Edge for membrane termination.
NOTE: Refer to Warranty Tables in Section 1.05 for specific metal edge requirements for projects with Total System Warranties or those with extended peak gust wind speed coverage greater than 80 miles per hour.
3. Metal work by others, when specified, must be fastened to prevent the metal from pulling free or buckling and sealed to prevent moisture from entering the roofing system or building. **Unless supplied by Versico, metal work securement is not included in this specification and is excluded from the Versico warranty.**
4. **On retrofit projects**, existing counter flashing, edging, expansion joint covers, copings, etc., shall not be reused unless investigated by the specifier to determine its compliance to Versico's current details.

Copyright 2026 Versico Roofing Systems
Versico, VersiGard, VersiCore, VersiTrim, DuraFaceR, LIQUISEAL and Flexible DASH Adhesive are Trademarks of Versico
Insulfoam, InsulLam, R-Tech by Insulfoam
Thermapink, Foamular and Durapink are Trademarks of Owens Corning
DensDeck, DensDeck Prime and DensDeck StormX Prime are Trademarks of Georgia-Pacific Corporation
Securock is a Trademark of USG
DEXcell® and DEXcell FA™ is a trademark of Gold Bond Building Products, LLC
OPTIM-R® is a registered trademark of Kingspan Group
ADVANCE-R® is a registered trademark of Panasonic Corporation
Styrofoam is a Trademark of Dow Chemical Company
OlyBond is a Trademark of OMG, Inc.

This specification represents the applicable information available at the time of its publication. Owners, specifiers and Versico authorized roofing contractors should consult Versico or their Versico Independent Sales Representative for any information that has subsequently been made available. Review the appropriate Versico warranty for specific warranty coverage, terms, conditions and limitations.



SPECIFICATION

ATTACHMENT

VersiGard Design “B” Loose-Laid Ballasted Roofing Systems

“Attachment I”

Ballast Criteria

January 2026

A. GENERAL

The specifier must evaluate the various conditions by which the ballast requirements are dictated. Building height, parapet height and project wind zone are major factors when specifying a minimum ballast requirement. The guidelines for ballast requirements which have been published by the following organizations should be referenced:

1. American National Standards Institute, ANSI/SPRI RP-4 (current edition) Wind Design Guide for Ballasted Single-Ply Roofing Systems. This standard is referenced in the current edition of the International Building Code (IBC).
2. Factory Mutual (FM) Research Corporation Loss Prevention Data Sheets 1-28 and 1-29.

B. BALLAST TYPES/COVERAGE RATES

The coverage rates listed below are considered minimum and are required by Versico for the issuance of the Versico warranty. Additional ballast coverage rates may be specified to provide additional wind uplift resistance.

1. **Rounded Water-Worn Gravel** may be placed directly on the EPDM membrane without additional membrane protection.
 - a. Minimum acceptable gradation:
 1. Nominal 1-1/2" rounded water worn gravel which conforms to the following gradation: 50% retained by a 3/4" screen, 95% retained by a 1/2" screen and 98% retained by a 1/4" screen. Use ASTM C136 method for sizing gravel.
 2. Alternately, #4, #3 and #24 stone (sized in accordance with ASTM D7765 method of sizing) may be used in lieu of the stone listed above.
 3. Coverage rate shall be no less than 1000 pounds per 100 square feet and ballast must be evenly distributed to maintain an average of 10 pounds per square foot.
 - b. Nominal 2-1/2" rounded water worn gravel which conforms to gradation #1 or #2 when sized in accordance with ASTM D7765 method of sizing. Coverage rate shall be no less than 1300 pounds per 100 square feet and gravel must be evenly distributed to maintain an average of 13 pounds per square foot.

2. **Standard sizes of coarse aggregate** - Based on ASTM D7765

Size Number	1	2	3	4
Nominal Size Square Openings	3-1/2" to 1-1/2"	2-1/2" to 1-1/2"	2" to 1"	1-1/2" to 3/4"
Amounts Passing Each Lab Sieve (Square Opening), Percent (%)				
4"	100			
3-1/2"	90 to 100			
3"		100		
2-1/2"	25 to 60	90 to 100	100	
2"		35 to 70	90 to 100	100
1-1/2"	0 to 15	0 to 15	0 to 15	90 to 100
1"				20 to 55
3/4"	0 to 5	0 to 5		0 to 15
1/2"			0 to 5	
3/8"				0 to 5

3. **Crushed Stone**, when specified, shall conform to the gradations approved for rounded water-worn gravel and must be installed in conjunction with Versico Protective Mat.

- a. Protective Mat must extend a minimum of 2" above the crushed stone at the perimeter and penetrations, but must be discontinued at scuppers, Dutch gutters and at drain bases.
- b. A minimum 6" overlap between adjacent sheets of HP Protective Mat must be specified.

4. **Individual Concrete Pavers**

- a. Individual pavers with a minimum weight of 18 pounds per square foot may be substituted for nominal 1-1/2" stone. Individual pavers with a minimum weight of 22 pounds per square foot may be substituted for nominal 2-1/2" stone.
- b. Individual pavers must be a maximum of two feet square. Unless otherwise required by Versico, pavers must weigh no more than 100 pounds per unit to allow for easy removal and replacement.
- c. Individual pavers with a surface other than a steel troweled finish as approved by Versico must be installed over Protective Mat and must be accepted by Versico prior to installation.

Elevating pavers should increase life expectancy, reduce freeze/thaw effects and promote more positive drainage. Acceptable pedestals can be specified under corners of pavers to elevate paver.

- d. Individual concrete pavers shall be loose laid and butted together with no gaps greater than 1/2".

5. **Lightweight Interlocking Concrete Pavers**

- a. Depending on the type of lightweight interlocking system, Versico Protective Mat or manufacturer's recommended matting may be required by Versico as a protection layer for the membrane. **Versico must be consulted prior to installation concerning protective matting requirements.**
- b. Lightweight interlocking pavers (minimum 10 pounds per square foot) may be substituted for nominal 1-1/2" stone or nominal 2-1/2" stone.
- c. When lightweight interlocking pavers are specified, the respective paver manufacturer must be consulted concerning installation criteria.

CAUTION: The securement method suggested by the respective interlocking paver manufacturer must be reviewed by Versico to determine membrane accessibility. If access to the membrane system is impaired by the paver interlocking mechanism (mechanical clips, strapping, adhesive, etc.), the building owner must assume the responsibility of providing access to the membrane for the purpose of investigation and warranty related repairs.

d. Lightweight Ballast Paver – 2' x 2' x 1.25" weighing 15 lbs/sq. ft.

6. Walkways

CAUTION: Molded Walkway pads not recommended within 10 feet of the perimeter of the roof on ballasted systems to avoid discontinuation of the primary membrane securement (ballast). In lieu of molded walkway pads, concrete pavers can be used when walkway is to be extended into the perimeter area.

- a. **Versico Interlocking Rubber Pavers:** A 2' x 2' x 2" thick rubber paver weighing approximately 24 pounds per unit, 6 pounds per square foot manufactured from recycled rubber, which provides a resilient, shock absorbing, weather resistant surface. Interlocking Rubber Pavers are designed primarily for use as a walkway or on terrace areas offering an environmentally sound design. Paver features bi-directional drainage and freeze/thaw stability. The Versico Interlocking Rubber Paver can be installed directly over the EPDM membrane without a separation layer.
- b. **Hanover Pedestal Paver** – Used for light traffic areas associated with rooftop or garden roof applications. 2'x2'x2.25" thick precast concrete pavers weighing 22 psf with an elevated clearance of 1/2" from incorporated footing. The pedestal paver can either be installed in conjunction with a separation layer of HP Protective Mat or using Pedestal and shims.

Note: EPDM Pedestal and Leveling Shims – A 3/8" fixed height EPDM rubber pedestal incorporating 1/8" spacer tabs. The pedestal allows pavers to follow the contour of the roof and may be combined with 1/8" or 1/16" leveling shims to prevent paver movement and provide a more stable feel. Both Hanover Pavers and leveling shims are available from Versico. (Refer to product section [Spec Supplement P-01 "Related Products"](#).)

- c. **Hanover Ballast and Lightweight Ballast Paver** - The standard, 24" x 24" x 1-13/16" thick, Ballast Paver comes in a natural color and a non-slip Diamond finish and weighs 22 lbs/sq. ft. The Lightweight, 23-1/2" x 23-1/2" x 1-1/4" thick, Ballast Paver comes in a natural color and a non-slip diamond finish and weighs 15 lbs/sq. ft. Both pavers can be used as ballast or walkways.

d. Other Walkway Considerations:

Smooth concrete pavers when specified in conjunction with insulation that is Mechanically Attached, must be loose laid over a slip sheet of membrane or 2 layers of Versico Protective Mat. When insulation is attached with Flexible DASH Adhesive, concrete pavers may be placed over one layer of Protective Mat. Pavers cannot weigh more than 80 pounds per paper for ease of removal

- 1) Walkways are considered a maintenance item and are excluded from the Versico warranty.
- 2) Window washing equipment will require special maintenance. Runways or window washing tracks must be utilized to prevent damage to membrane or insulation. Such details must be reviewed by Versico to determine reasonable access to the membrane and associated insulation/underlayment components.

END OF SECTION



SPECIFICATION

ATTACHMENT

VersiGard® Design EPDM Roofing Systems Adhered, Ballasted and Mechanically Fastened

“Attachment II” 25/30 Year Warranty Design Enhancements

January 2026

Information contained in this Attachment outlines necessary enhancements required for projects where a 25 or 30-year Warranty is specified. At the applicator’s or specifier’s discretion, projects may be forwarded to Versico for warranty review prior to installation or bid.

Section	Page
A. General	56
B. Membrane Criteria	56
Non-Reinforced Membrane Criteria and Hail Coverage Table	57
Reinforced Membrane Criteria and Hail Coverage Table	57
C. Adhered System Design Criteria.....	58
D. Mechanically Fastened System Design Criteria	59
E. Ballasted System Design Criteria	60
F. Roof Deck Criteria	62
G. Flashing/Terminations	63

A. General

1. All products specified for these roofing assemblies must be products manufactured or marketed by Versico.
2. On retrofit projects, all existing roofing material shall be totally removed.
3. All projects, a final shop drawing shall be approved by Versico prior to installation. Shop drawings must include all pertaining details. As-Built projects are not recommended.
4. The roof assembly will vary based on warranty wind speed and hail coverage. As identified in Warranty Tables, included in this attachment.
5. An air/vapor barrier shall be used when required and must be sealed around perimeter and roof penetrations. When not specified, the roof membrane shall be adhered over perimeter wood nailer along edges to prevent air infiltration along edging, regardless of assembly type (Ballasted, Adhered and Mechanically Fastened).
6. Due to warranty length, covered in this attachment, special consideration should be given to the total R-Value of the roof assembly. Utilizing the International Energy Conservation Code (IECC) to determine the minimum level of insulation for the building project's location is recommended.
7. To optimize energy efficiency, insulation shall be installed in multiple layers with joints staggered.
8. For limitations and specific types of insulation/underlayments refer to "Section E Insulation/Underlayments"
9. 1/4" per horizontal foot slope is preferred; however 1/8" slope with sufficient number of drains and crickets / saddles may be accepted. Assemblies described in this attachment are governed by the maximum slope limit described in the current Versico publication.
10. Refer to [Specification Supplement E-02 "EPDM Membrane Splicing and Splice Repairs"](#) and applicable Versico Details for additional design enhancements.

B. Membrane Criteria

1. **Adhered Roofing Systems**, the roofing membrane shall be a minimum of **60-mil thick VersiGard (black or white) Non-Reinforced EPDM Membrane** utilizing enhanced details for **25 Year Warranty** Duration

OR

90-mil VersiGard Non-Reinforced Membrane OR 75-mil thick VersiGard Reinforced Membrane utilizing enhanced details for **30 Year Warranty** Duration.

2. **Ballasted Roofing Systems**, the roofing membrane shall be a minimum of **60-mil thick VersiGard Non-Reinforced Membrane** utilizing enhanced details for **30 Year Warranty** Duration

OR

90-mil thick VersiGard Non-Reinforced Membrane utilizing enhanced details for **30 Year Warranty** Duration. Maximum membrane width, not to exceed 10' wide.

3. **Mechanically Fastened Roofing Systems**, the roofing membrane shall be a minimum of **75-mil thick VersiGard Reinforced Membrane** utilizing enhanced details for 25 or 30 Year Warranty Duration.

4. **Non-Reinforced Membrane Criteria and Hail Coverage**

Years	VersiGard (Black or White) Non-Reinforced Membranes				
	Warranty Wind Speed Coverage			Minimum Membrane Thickness	Hail Coverage
	55, 72 or 80 mph		90 to 120 mph		
	Adhered (2)	Ballasted (1)	Adhered (2)		
25 year	NA	✓	NA	VersiGard 45-mil OR VersiGard White 60-mil	
25 year	✓	NA	✓	VersiGard (Black or White) 60-mil OR VersiGard/VersiGard White QA 60-mil (3)	
30 year	NA	✓	NA	VersiGard 60-mil / VersiGard White 60-mil	
30 year	✓	✓	✓	VersiGard (Black or White) 90-mil	

- Notes: NA = Not Acceptable ✓ = Acceptable
 (1) VersiGard White membrane is not recommended for ballasted systems.
 (2) Standard G200-SA or EPDM x-23 Low-VOC Bonding Adhesive must be utilized.
 (3) VersiGard QA and VersiGard White QA limited to a maximum warranty wind speed coverage of 100 mph

5. **Reinforced Membrane Criteria and Hail Coverage**

Years	VersiGard Reinforced Membranes					
	Warranty Wind Speed Coverage				Minimum Membrane Thickness	Hail Coverage (Adhered Systems Only)
	55, 72, 80 or 90 mph		100 to 120 mph			
	Adhered (1)	Mech. Fastened	Adhered (1)	Mech. Fastened		
25 year	✓	N/A	✓	NA	VersiGard Reinforced QA 75-mil	
25 or 30 year	✓	✓	✓	NA	VersiGard Reinforced 75-mil	

- Notes: NA = Not Acceptable ✓ = Acceptable
 (1) Standard G200-SA, EPDM x-23 Low-VOC or CAV-GRIP 3V Bonding Adhesive must be utilized.
 (2) VersiGard Reinforced QA limited to a maximum warranty wind speed coverage of 100 mph.

C. Adhered System Design Criteria (25 YR to 30 YR Warranty)

1. Building height shall not exceed 100'. For projects where building height exceeds 100' or warranty wind speed exceeds 100 mph, please submit to Versico for review.
2. All Field Splice "T-Joints" must be overlaid as described in **Detail VGC-2.1**.
3. The criteria is for compliance with Versico's requirements for warranty, when FM Compliance is required for a specific project refer to FM Documentation and Versico Code Listings.
4. 6" on center fastening required for Pressure Sensitive RTS.
5. New or Tear-off applications for Steel Decks: Cover boards must be installed over minimum 1" thick approved Versico insulation.
6. Table below outlines insulation/underlayment requirements and application attachment methods:

Maximum Peak Gust Wind Speed Warranty	Minimum Membrane Underlayment		Insulation/Underlayment Attachment			Metal Edging
			# of Fasteners per 4' x 8' board size	Adhesive Ribbon Spacing for 4' x 4' size board		
				Field	Perimeter	
55 or 72 MPH	Cover Board over Insulation	1-1/2" to 2" (25 psi) Polyisocyanurate (1)	16	6" (4)	6"	Versico Drip Edge may be fastened with ring shank nails staggered 4" on center. Versico HPV or HPVX Fasteners may also be used fastened 12" on center.
		1/2" Versico Recovery Board (2)(6)				
		1/4" DensDeck Prime (3)				
		1/4" Securock or 1/4" Securock Ultralight Coated Glass-Mat (3)				
		1/4" DEXcell® Glass Mat or 1/4" DEXcell FA™ Glass Mat (3)				
80 MPH	Cover Board over Insulation	1-1/2" to 2" (25-psi) SecurShield Polyiso or 1-1/2" to 2" (25-psi) SecurShield Eco	20	6"	6"	Versico Drip Edge (5), VersiTrim EX Drip Edge.
		1/2" SecurShield HD or 1/2" SecurShield HD Eco (3)	16			
		1/2" SecurShield HD Plus (3)	16			
		1/2" DEXcell® Glass Mat or 1/2" DEXcell FA™ Glass Mat(3)	16			
90 MPH	Cover Board over Insulation	1/2" Securock or 1/2" Securock Ultralight Coated Glass-Mat (3)	20	FS	FS	VersiTrim EX Drip Edge
		1/2" DensDeck Prime (3)				
		1/2" DEXcell® Glass Mat or 1/2" DEXcell FA™ Glass Mat (3)				
		1/2" SecurShield HD Plus (3)				
100 MPH	Cover Board over Insulation	1/2" DuraStorm VSH (3)	16	FS	FS	VersiTrim EX Drip Edge
		5/8" DEXcell® Cement Roof Board				
		1/2" SecurShield HD Plus (3)	20			
		1/2" SecurShield HD or 1/2" SecurShield HD Eco (3)	24			
110 or 120 MPH	Cover Board over Insulation	1-1/2" DuraFaceR (OSB/Polyiso Composite) (3)	16	FS	FS	VersiTrim EX Drip Edge
		5/8" DensDeck Prime or 5/8" DensDeck StormX Prime (3)				
		5/8" Securock and 5/8" Securock Ultralight Coated Glass-Mat (3)				
		5/8" DEXcell Glass Mat®, 5/8" DEXcell FA™ Glass Mat or 5/8" DEXcell FA VSH® (3)				
		2" SecurShield HD Composite (3)				
		1/2" DuraStorm VSH (3)	24			
		1/2" SecurShield HD Plus (3)				

Notes:

FS = Full Spray or Ribbons @ 4" O.C.

All Versico Products listed for higher wind speed coverage can also be used for Warranties for lower speed coverage.

(i.e. 72 MPH underlayment may be used for 55 MPH underlayment)

- (1) Not for use directly on concrete decks when adhesion is specified to the structural deck.
- (2) For Building heights between 51'-100', enhance 12'-wide perimeter with 50% more fasteners and plates.
- (3) Hail coverage offered with substrate when Flexible DASH Adhesive is used for cover board attachment.
- (4) Structural Concrete - Field @ 12" O.C. / Perimeter @ 6" O.C.
- (5) Versico HPV or HPVX Fasteners must be used to secure Versico Drip Edge to perimeter wood nailers.
- (6) 1/2" Recovery Board limited to 55 mph.

D. Mechanically Fastened System Design Criteria (25 YR to 30 YR Warranty)

- 1. Building height limitation depends on structural deck type. Projects with structural concrete or steel decks are limited to 100' in height. Projects with plywood decks (3/4" min.) or with Wood plank (1" min.) are limited to a maximum height of 60'. For projects where building height exceeds 100' or warranty wind speed exceeds 100 mph, please submit to Versico for review.
- 2. All Field Splice "T-Joints" must be overlaid as described in [Detail VGMA-2.1A](#).
- 3. This criteria is for compliance with Versico's requirements for extended warranties, when FM Compliance is required for a specific project refer to FM Documentation and Versico Code Listings.
- 4. Fasteners covered in this attachment are limited to a length not to exceed 12". Assemblies with Tapered Insulation, requiring longer fasteners than 12", shall be reviewed by Versico.
- 5. 6" on center fastening required for Quick-Applied RTS.
- 6. Table below outlines insulation/underlayment requirements and application attachment methods:

Maximum Peak Gust Wind Speed Warranty	Deck Type	Insulation Thickness	Minimum Membrane Underlayment	Insulation Underlayment Attachment	Metal Edging
				# of Fasteners per 4' x 8' board size	
Up to 72 MPH	Steel, Concrete or Wood Deck	<5"	1-1/2" to 2-1/2" VersiCore MP-H, SecurShield Polyisocyanurate or SecurShield Eco	5	Versico Drip Edge may be fastened with ring shank nails staggered 4" on center. Versico HPV or HPVX Fasteners may also be used fastened 12" on center.
		>5"	Overlay 1/2" SecurShield HD or SecurShield HD Eco Cover Board over VersiCore MP-H or SecurShield Polyisocyanurate or SecurShield Eco	4	
80 MPH	Steel or Concrete Deck	Any Thickness	Overlay 1/2" SecurShield HD or SecurShield HD Eco Cover Board over VersiCore MP-H or SecurShield Polyisocyanurate or SecurShield Eco	4	Versico Drip Edge (1) or VersiTrim EX Drip Edge.
90 MPH	Steel or Concrete Deck	Any Thickness	Overlay 1/2" SecurShield HD or SecurShield HD Eco Cover Board over VersiCore MP-H or SecurShield Polyisocyanurate or SecurShield Eco	4	VersiTrim EX Drip Edge

Notes:

- (1) Versico HPV or HPVX Fasteners must be used to secure Versico Drip Edge to perimeter wood nailers.
- (2) An air/vapor barrier shall be used when required and must be sealed around perimeter and roof penetrations. When not specified, the roof membrane shall be adhered over perimeter wood nailer along edges to prevent air infiltration along edging, regardless of assembly type.

**(VersiGard Reinforced Membrane Only)
22 GA. Steel Deck or Structural Concrete**

Peak Gust Wind Speed Warranty	Max. Building Height	Min. Number of Perimeter Sheets			Field Membrane Width	Perimeter Sheet Width	Fastening Density (Field Sheets)	Fastening Density (Perimeter Sheets)
		Building Distance to Coastline						
		Greater than 7 miles	3 to 7 miles	Less than 3 miles				
55 MPH	Up to 60'	2	3	4	10'	Note 3	12" O.C.(1)	12" O.C.(1)
	61' to 100'	3	3	4	10'	Note 3	6" O.C.(1)	6" O.C.(1)
72 MPH	Up to 60'	3	3	4	10'	Note 3	6" O.C.(1)	6" O.C.(1)
	61' to 100'	4	5	5	10'	Note 3	6" O.C.(1)	6" O.C.(1)
80 MPH	Up to 60'	4	4	5	10'	Note 3	12" O.C.(2)	12" O.C.(2)
	61' to 100'	4	5	5	10'	Note 3	12" O.C.(2)	12" O.C.(2)
90 MPH	Up to 60'	4	5	5	10'	Note 3	12" O.C.(2)	12" O.C.(2)
	61' to 100'	5	5	5	10'	Note 3	12" O.C.(2)	6" O.C.(2)

- (1) Using HPV Fasteners on Steel Deck with 2" Polymer Seam Plates
(2) Using HPV-XL Fasteners and 2-3/8" Polymer (HPV-XL) Plates
(3) Split Field sheet using a 9" Quick-Applied RTS along the center of the sheet.

**(VersiGard Reinforced Membrane Only)
Wood Decks**

Peak Gust Wind Speed Warranty	Deck Type	Projected Pull-Out Values	Min. Number of Perimeter Sheets		Field Membrane Width	Perimeter Sheet Width	Fastening Density (Field & Perimeter Sheets)
			Building Distance from Coastline				
			Greater than 7 miles	Less than or equal to 7 miles			
55 MPH	3/4" Plywood (2)	450 lbs	2	2	10'	Note 1	12" O.C.
72 MPH	Wood Plank (2)	540 lbs	2	2	10'	Note 1	12" O.C.
	3/4" Plywood (2)	450 lbs	2	4	10'	Note 1	12" O.C.
80 MPH	Wood Plank (2)	540 lbs	2	4	10'	Note 1	6" O.C.
90 MPH	Contact Versico for Approval and Evaluation						

- (1) Split Field sheet using a 9" Quick-Applied RTS along the center of the sheet.
(2) Maximum Building Height Up to 60'

E. Ballasted Design Criteria (25 YR to 30 YR Warranty)

1. Building height shall not exceed 60'. For projects where building height exceeds 60' or warranty wind speed exceeds 80 mph, please submit to Versico for review.
2. All Field Splice "T-Joints" must be overlaid as described in [Detail VGC-2.2](#).
3. For applicable membrane thickness, refer to Tables in Section B4.
4. 6" on center fastening required for Quick-Applied RTS.

General

1. Versico Polyisocyanurate or Insulfoam EPS Insulation shall be applied in multiple layers with joints staggered between layers, following current energy codes. The layer directly under the membrane shall be 1-1/2" thick insulation and shall be loose-laid or, if specified, may be secured with bead adhesive (12" O.C. bead spacing is acceptable).

CAUTION: The use of Mechanically Fasteners is not permitted for insulation securement.

Polyisocyanurate Insulation

1. When Polyisocyanurate insulation is specified, VersiCore or SecurShield (20 or 25 psi) shall be utilized and is recommended. On structural and lightweight structural concrete, to safeguard against residual moisture, the use of SecurShield Polyisocyanurate is required.

Expanded Polystyrene (EPS) Insulation

1. When EPS (Expanded Polystyrene) insulation is to be utilized, only Insulfoam EPS may be used as follows:
 - a. Insulfoam I (1.0 pcf density) EPS.
 - b. Insulfoam VIII (1.25 pcf density) EPS.
2. On steel decks, install EPS insulation in conjunction with thermal barrier, if required for code compliance.
3. When directly installed on steel deck, total thickness of insulation must be adequate to span deck flutes.

Ballast Types/Coverage Rates

- b. The coverage rates listed in this attachment are considered minimum and are required by Versico for issuance of the standard Versico warranty. Depending on specific project conditions (building height, parapet height and project location), additional ballast may be necessary to provide wind uplift protection. Refer to "Attachment I" in this Specification for suitable ballast types and coverage rates. **Comply with the specifier's requirements when an additional ballast coverage rate is specified.**
- c. **Rounded Water-Worn Gravel** must be applied over the EPDM membrane at the minimum rate of **1000 pounds per square** and must be evenly distributed to maintain an average of 10 pounds per square foot.

ASTM D 7765 SIZE NUMBER	MINIMUM COVERAGE RATE (pounds per square)	AVERAGE COVERAGE RATE (lbs./sq. ft. continuously distributed)
4 (1-1/2" nominal diameter)	1000	10
3 (2" nominal diameter)	1000	10
2 (2-1/2" nominal diameter)	1300	13
1 (3-1/2" nominal diameter)	1300	13

Notes: In the field of the roof, some bare spots resulting from installation are permitted; however, they must not exceed 64 square inches and must be limited to no more than 2 per square (100 square feet). No bare spots are permitted in the perimeter area of the roof that is 10' wide.

d. Smooth Surfaced Individual Concrete Pavers

- 1) When the use of concrete paver is specified, Versico supplied Hanover Pedestal Paver is recommended and can be covered by the Versico Warranty. A pedestal system is recommended, due to increased life expectancy, however, field fabricated, cut sections (8" x 8") of VersiGard Black Quick-Applied / VersiGard White Peel & Stick Molded Walkway Pads, beneath pavers, at corners of pavers.
- 2) Individual pavers must be a maximum of two feet square. Unless otherwise required by Versico, pavers must weigh no more than 80 pounds per unit to allow for easy removal and replacement.
- 3) Individual pavers with a surface other than a steel troweled finish as approved by Versico, must be installed over

Versico HP Protective Mat and must be accepted by Versico prior to installation.

- 4) Elevating pavers should increase life expectancy, reduce freeze/thaw effects, and promote more positive drainage. Acceptable pedestals can be specified under corners of pavers to elevate paver.
- 5) Individual concrete pavers shall be loose laid and butted together with no gaps greater than 1/2".

Ballast Criteria for Up to 30 Year Extended Warranty

- a. Refer to installations below for calculating corner/perimeter areas for the noted warranty wind speeds available.

Ballast Requirements for 72 mph Warranty

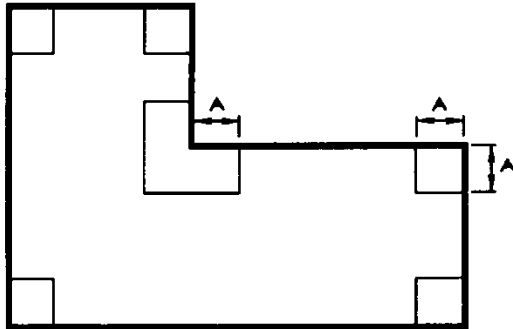

A (Corners) = .4 Times the Building Height
(10' minimum)

Ballast Requirements for 80 mph Warranty

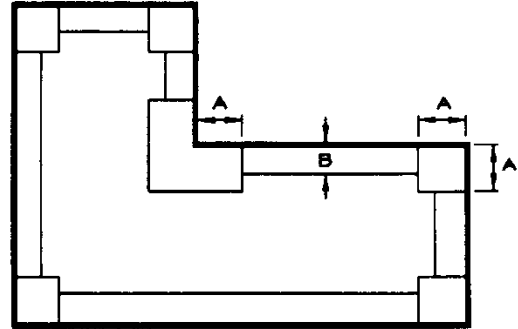

A (Corners) = .4 Times the Building Height
(10' minimum)
B (Perimeters) = 10'

2. At corner and/or perimeter areas, ballast shall be 2-1/2" nominal rounded water worn gravel conforming to gradation #1 or #2 in accordance with ASTM D7765 method of sizing. Coverage rate shall be a minimum of 15 pounds per square foot.
3. In field areas, ballast shall be 1-1/2" nominal rounded water worn gravel conforming to gradation #4 in accordance with ASTM D7765 method of sizing. Coverage rate shall be a minimum of 12 pounds per square foot.
4. Other ballasting configurations may be authorized by Versico, upon review and approval, prior to construction.

F. Roof Deck Criteria

1. Steel (22 gauge or heavier) – **HPV, HPV-X, HPV-XL or InsulTite Fasteners are required, with a minimum pullout of not less than 360 pounds per fastener for adhered systems and 425 pounds per fastener for mechanically fastened systems.**

NOTE: Versico InsulTite fasteners may be used with adhered systems only, if the minimum pullout requirement is met.

2. Structural Concrete (minimum 3,000 psi) – **MP 14-10 (threaded) Fasteners are required with a minimum pullout of 800 pounds per fastener.** CD-10 (hammer-driven) is also applicable for adhered membrane assemblies. **In lieu of fastening, Flexible DASH Adhesive is an acceptable alternative for insulation attachment for adhered assembly when used in conjunction with coated glass faced insulation and full spray.**

NOTE: The use of standard (paper) faced Polyisocyanurate is not acceptable. Due to possible presence of residual moisture in concrete slabs.

3. Wood Plank (minimum 1" thick) or minimum 3/4" thick Plywood – **HPV, HPV-X or InsulTite Fasteners are required with a minimum pullout of 425 pounds for plywood and wood plank; 450 pounds for mechanically fastened systems. Pullout value for adhered systems is 360 pounds per fastener.**

NOTE: Versico InsulTite fasteners may be used with adhered systems only if the minimum pullout requirement is

met.

4. For **Ballasted Assemblies**, the structural deck must be able to sustain the weight of a ballasted assembly (12-15 lbs of ballast, as well as other components, i.e. membrane, insulation and vapor barriers, if applicable). The structural deck must be sufficient to support concentrated construction traffic and point loading.

G. Flashing, Terminations and Other Considerations (All Assemblies)

1. All existing flashing must be removed prior to the application of new membrane. New membrane flashing must not conceal weep holes or cover existing through wall counterflashing.
2. Wall flashings shall extend above the anticipated slush line, prior to written approval from Versico is required for lower heights of flashing.
3. Pre-fabricated accessories must be utilized, where applicable.
4. Project details must be reviewed by Versico, preferably prior to bid, and a written approval must be obtained. As a warranty prerequisite, the approval shall be included as part of the project submittals along with the Request for Warranty form that is required for project approval.
5. Only Versico supplied Sheet Metal and Edging is to be used on all projects unless prior authorization from Versico has been obtained.
6. Versico Termination Bar is required in locations where a compression bar termination has been specified. The Termination Bar must be used in conjunction with new or existing counterflashing.
7. Where new or existing counterflashing is used, Versico's Termination Bar must be used as the primary termination.
8. Certain metal accessories by others may be permitted upon Versico acceptance for wind speed coverage less than 72 mph.



EPDM

ROOFING SYSTEMS

VersiGard® EPDM Roofing Systems Fully Adhered, Ballasted and Mechanically Attached

Installation Details

TABLE OF CONTENTS

January 2026

Ballasted	Detail
VersiTrim Snap-On Canted Fascia.....	VGB-1.1
Deck to Deck Expansion Joint.....	VGB-3.0
Mechanically Attached	
VersiTrim Snap-On Canted Fascia.....	VGMA-1.1
Mechanically Attached EPDM Securement – Option 1	VGMA-2.0A
Mechanically Attached EPDM Securement – Option 2 (RTS).....	VGMA-2.0B
Mechanically Attached EPDM Securement – Option 3 (RTS).....	VGMA-2.0C
Mechanically Attached EPDM Membrane Splice	VGMA-2.1
Mechanically Attached EPDM Membrane Splice (30 Year Warranty).....	VGMA-2.1A
Mechanically Attached EPDM Membrane Splice Intersection.....	VGMA-2.2
Mechanically Attached EPDM Membrane Splice Intersection (30 Year Warranty)	VGMA-2.2A
End Lap Splice	VGMA-2.3
Roof Drain with Sump	VGMA-6.0
Quick-Applied Pipe Seal.....	VGMA-8.1
Quick-Applied Pipe Seal with 20” Quick-Applied (QA) Cured Flashing	VGMA-8.1A
Field Fabricated Pipe Wrap.....	VGMA-8.2
Ridge Membrane Attachment	VGMA-22.0
Metal Edges and Gravel Stops	
VersiTrim Snap-On Canted Fascia.....	VGC-1.1
VersiTrim Snap-On Canted Fascia (30 Year Warranty)	VGC-1.1A
VersiTrim EX Snap-On Fascia & VersiTrim Snap-On Fascia.....	VGC-1.3
Versico Drip Edge Fascia.....	VGC-1.4
Versico Drip Edge Fascia (30 Year Warranty)	VGC-1.4A
VersiTrim One-piece Gravel Stop.....	VGC-1.5
Metal Bar Edge Termination.....	VGC-1.6
Membrane Splices	
EPDM Membrane Splices	VGC-2.1
EPDM Membrane Splices (30 Year Warranty).....	VGC-2.1A
EPDM Membrane Splice Intersection.....	VGC-2.2
EPDM Membrane Splice Intersection (30 Year Warranty Or 90-mil Membrane)	VGC-2.2A
EPDM Membrane Splices at Angle Change (30 Year Warranty)	VGC-2.3
SAT EPDM Membrane Splices	VGC-2.4
Expansion Joints	
Deck-to-Deck Expansion Joint	VGC-3.1
Deck-to-Deck Curbed Expansion Joint.....	VGC-3.1A
Deck-to-Wall Expansion Joint	VGC-3.2
Shear/Expansion Cover	VGC-3.3
Curb Flashing	
Curb Flashing – EPDM Membrane.....	VGC-5.1
Curb Flashing - Quick-Applied Curb Wrap with 6” Tape.....	VGC-5.2
Curb Flashing – with 20” Quick-Applied Cured Flashing	VGC-5.3

Self-Flashing Curb, Roof Hatch or Skylight	VGC-5.4
New Self-Flashing Metal Curb.....	VGC-5.5

Drains

Roof Drain.....	VGC-6.1
Roof Drain – Reinforced Field Sheet with Sump Exceeding 3” Per Foot.....	VGC-6.2
VersiGard Insert Drain.....	VGC-6.3
Insert Drain Through Deck.....	VGC-6.4
VersiGard Add-On Drain	VGC-6.5

Pipe Flashing

Quick-Applied Pipe Seal.....	VGC-8.1
Quick-Applied Pipe Seal with 90-mil Membrane or 30 Year Warranties.....	VGC-8.1A
Field Fabricated Pipe Wrap.....	VGC-8.2
Field Fabricated Pipe Wrap (30 Year Warranties).....	VGC-8.2A
Flexible Penetration.....	VGC-8.3
Flexible Penetration (30-Year Warranty).....	VGC-8.3A
Field Fabricated Hot Stack.....	VGC-8.4
Field Fabricated Hot Stack (30 Year Warranties).....	VGC-8.4A

Terminations

Membrane Terminations, Page 1 of 3	VGC-9.0A
Membrane Terminations, Page 2 of 3	VGC-9.0B
Membrane Terminations, Page 3 of 3	VGC-9.0C

Parapet / Curb Flashing

Parapet/Curb with Continuous Membrane	VGC-12.1
Parapet/Curb with Separate Membrane Flashing	VGC-12.2
Parapet / Curb with Continuous Membrane – RUSS	VGC-12.3
Parapet / Curb with Separate regular EPDM Flashing	VGC-12.4
Parapet / Curb with Separate SAT Flashing.....	VGC-12.5
Parapet / Curb with Continuous Membrane – Cover Strip.....	VGC-12.6

Tie-Ins

Built-Up Roofing Tie-In over Steel Roof Deck	VGC-13.1
Built-Up Roofing Tie-In over Concrete Roof Deck.....	VGC-13.2
Tie-In to Existing EPDM Membrane	VGC-13.3
EPDM Tie-In Over Concrete Deck	VGC-13.4
Tie-In Shingled Or Metal Panel Roof.....	VGC-13.5
Tie-In Between New Versico Adhered & Ballasted Roof.....	VGC-13.6

Inside/Outside Corners

Inside Corner Wall Flashing with RTS (Option 1).....	VGC-15.1
Inside Corner Wall Flashing with RTS (Option 2).....	VGC-15.2
Inside Corner with Continuous EPDM Wall Flashing	VGC-15.3
Inside Corner with Separate EPDM Wall Flashing	VGC-15.4
Inside Corner Flashing for Projects with 90-mil Membrane or 30 Year Warranties	VGC-15.4A
Outside Corner with Pre-Cut Quick-Applied Corner	VGC-15.5
Outside Corner with Quick-Applied Uncured EPDM Flashing (2 Piece).....	VGC-15.6
Outside Corner with Quick-Applied Uncured EPDM Flashing (1 Piece).....	VGC-15.7
Outside Corner Flashing for Projects with 90-mil Membrane or 30 Year Warranties	VGC-15.7A

Sealant Pocket

Quick-Applied Pourable Sealer Pocket	VGC-16.1
Quick-Applied Pourable Sealer Pocket (30 Year Warranties).....	VGC-16.1A
Field Fabricated Pourable Sealer Pocket.....	VGC-16.2
Field Fabricated Pourable Sealer Pocket (30 Year Warranties).....	VGC-16.2A
Extended Pourable Sealer Pocket	VGC-16.3
Extended Pourable Sealer Pocket (30 Year Warranties).....	VGC-16.3A

Through-Wall Scupper

Metal Scupper at Deck.....	VGC-18.1
Scupper: Double Layers Flashing – Page 1 of 2.....	VGC-18.1A
Scupper: Double Layers Flashing – Page 2 of 2.....	VGC-18.1A

Lightning Rod

Lightning Rod at Parapet (Vertical Attachment)VGC-20.1
Lightning Rod at Deck LevelVGC-20.2

Valley

Valley DetailVGC-22.0

Sleeper

Sleeper Detail.....VGC-24.0

Penetration

I-Beam PenetrationVGC-30.0

VERSITRIM
SNAP-ON CANTED
FASCIA OR METAL
FASCIA BY OTHERS.
ALSO SEE [VGC-1.3](#)
(BOTTOM DETAIL)
FOR DIFFERENT
FASCIA OPTION

MAXIMUM MEMBRANE THICKNESS GOING OVER THE
WATER DAM IS 60-MIL. FOR THICKER MEMBRANES,
RUN FIELD SHEET UNDER THE WATER DAM AND
STRIP-IN WITH MAXIMUM 60-MIL MEMBRANE

GALVANIZED
METAL WATER
DAM

VERSICO BONDING
ADHESIVE

NOTE:

1. FOR GUTTER EDGE WITH
BALLASTED ROOF
ASSEMBLY, SEE DETAIL
B ON [VGC-1.6](#)

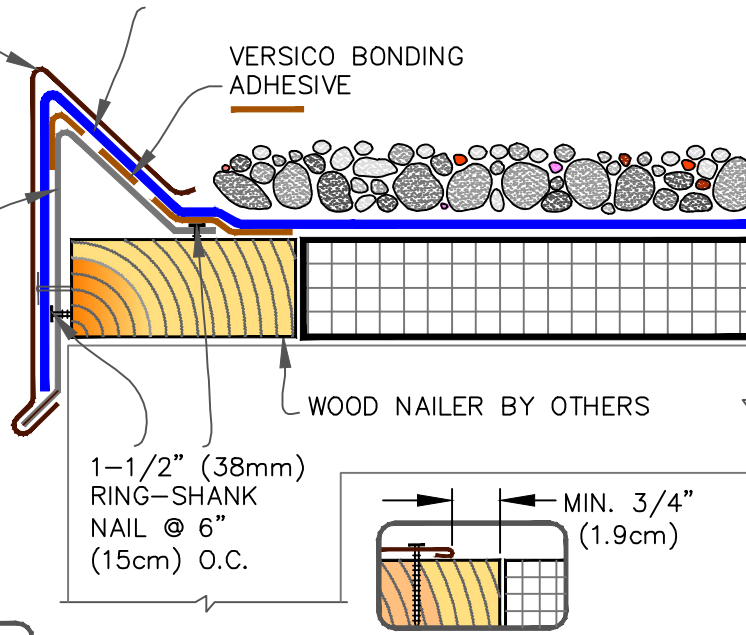

DIMENSION	cm	
(A) 3"	7.5	MIN.

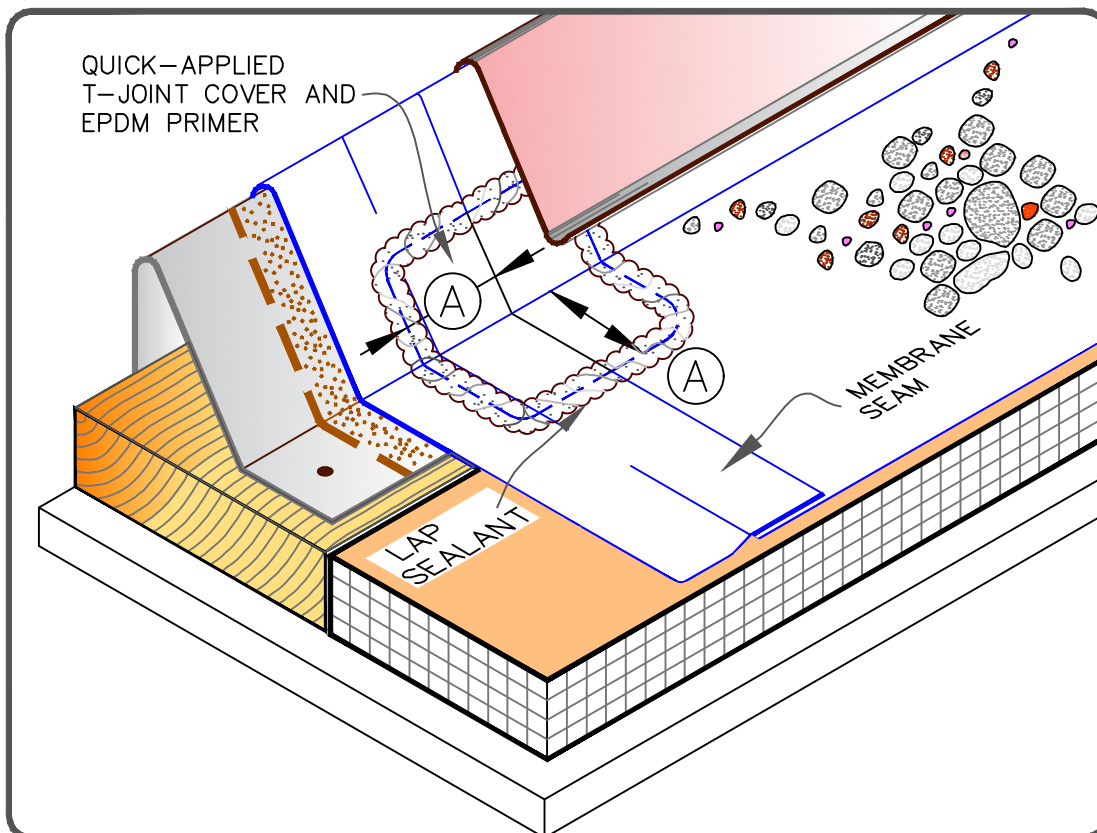

MAXIMUM WARRANTY: 30 YEARS



VERSITRIM SNAP-ON
CANTED FASCIA

- EPDM MEMBRANE
- APPROVED SUBSTRATE
- SEE NOTE(S)

VersiGard BALLASTED
(EPDM)

VGB-1.1

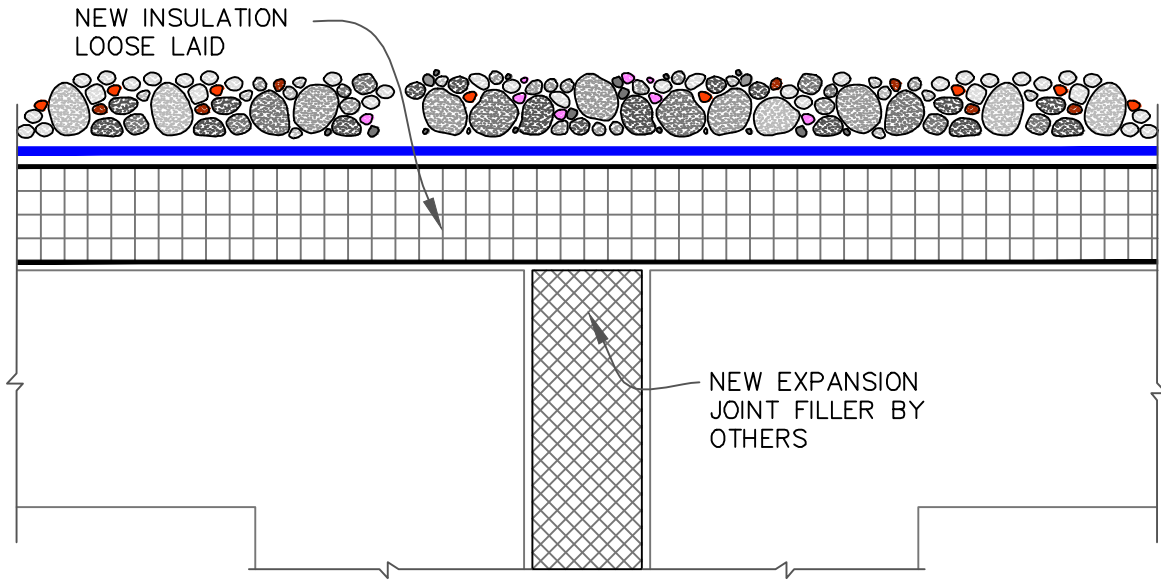

A NEW CONSTRUCTION OR REROOFING

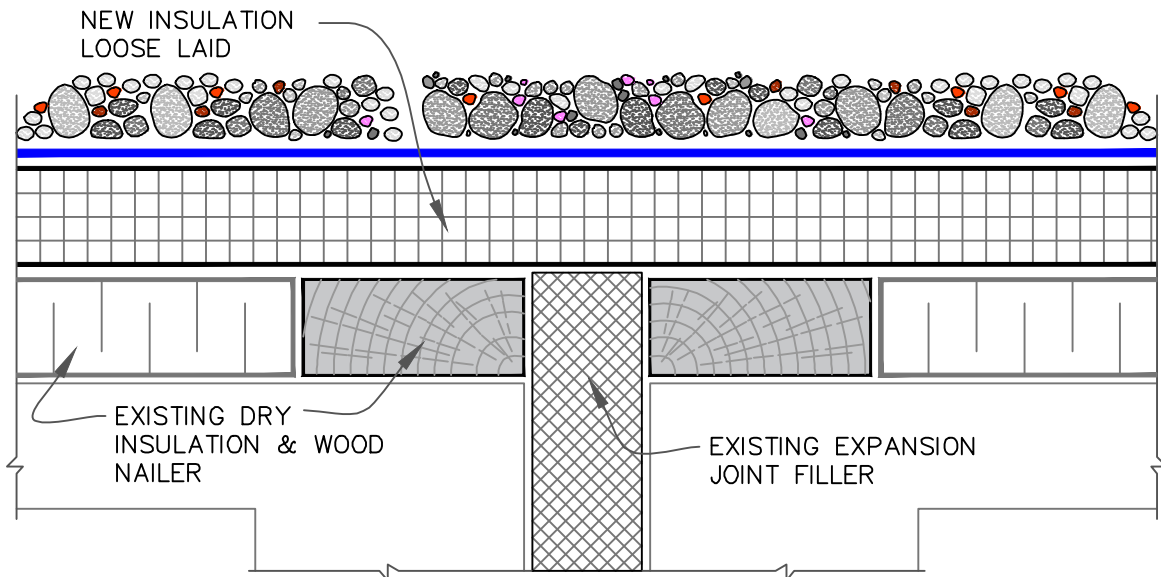

B REROOFING OR RECOVER OF EXISTING ROOF

NOTE:

1. ANY OF [VGC-3.1 OR 3.2 OR 3.3](#) EXPANSION JOINT DETAIL CAN BE USED WITH THE "B" SYSTEM (BALLASTED STONE ASSEMBLY)

MAXIMUM WARRANTY: 30 YEARS



DECK-TO-DECK
EXPANSION JOINT

	→ EPDM MEMBRANE
	→ APPROVED SUBSTRATE
	→ SEE NOTE(S)

VersiGard BALLASTED (EPDM)
VGB-3.0

MAXIMUM MEMBRANE THICKNESS GOING OVER THE WATER DAM IS 60-MIL. FOR THICKER MEMBRANES, RUN FIELD SHEET UNDER THE WATER DAM AND STRIP-IN WITH MAXIMUM 60-MIL MEMBRANE

VERSICO BONDING ADHESIVE

MIN. 9" (23cm) WIDE PIECE OF 45-MIL REINFORCED EPDM MEMBRANE

3" (7.5cm) WIDE QA SEAM TAPE AND EPDM PRIMER

VERSITRIM SNAP-ON CANTED FASCIA OR METAL FASCIA BY OTHERS

GALVANIZED METAL WATER DAM

1-1/2" (38mm) RING SHANK NAILS @ 6" (15cm) O.C. MAX.

WOOD NAILER BY OTHERS

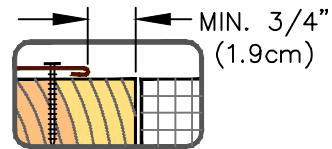

DIMENSION	cm	
(A) 3"	7.5	MIN.

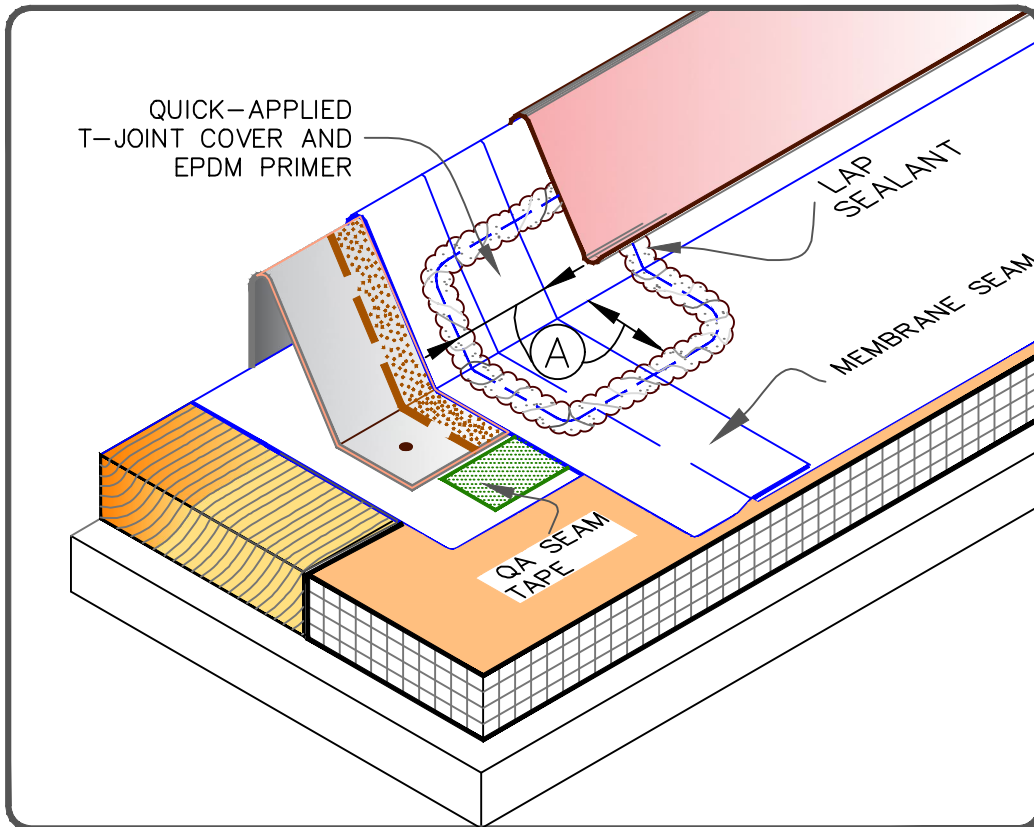

MAXIMUM WARRANTY: 30 YEARS



VERSITRIM SNAP-ON CANTED FASCIA

- EPDM MEMBRANE
- APPROVED SUBSTRATE
- SEE NOTE(S)

VersiCard MECHANICALLY ATTACHED (EPDM)

VGMA-1.1

GUIDELINES FOR ROOF PERIMETER ZONES FOR MECHANICALLY ATTACHED ROOF SYSTEM

 PERIMETER ZONES

SPLIT LEVEL ROOFS

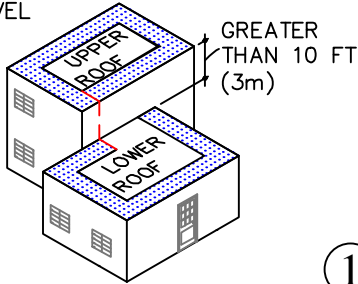

1

SPLIT LEVEL ROOFS

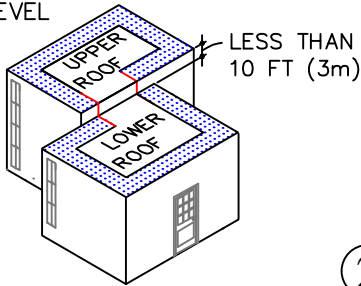

2

CANOPY ROOF

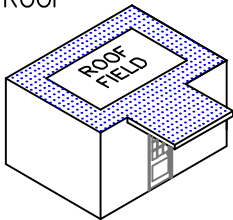

INSTALL PERIMETER SHEETS OVER THE ENTIRE OVERHANG AREA, EXTENDING ONTO THE MAIN ROOF DECK WHEN AT THE SAME LEVEL AS SHOWN.

3

LARGE OPENINGS OR LOADING DOCKS

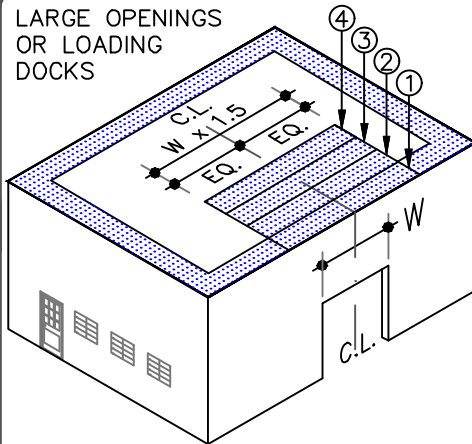

4 PERIMETER SHEETS CENTERED OVER LARGE OPENINGS

4

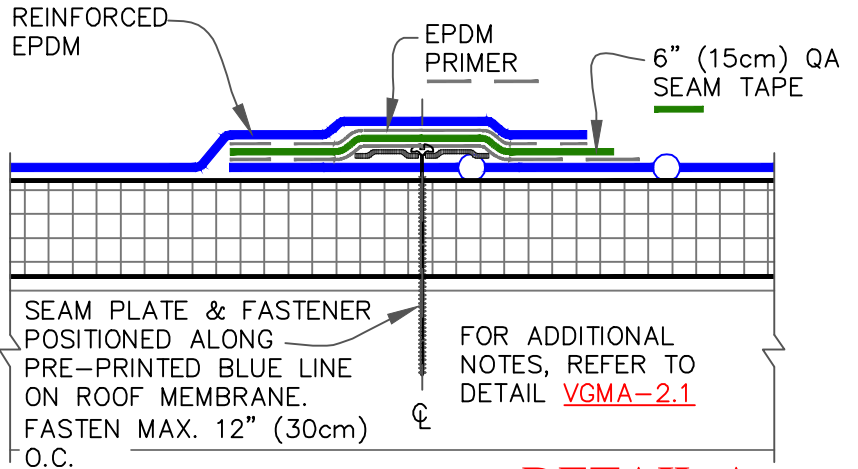
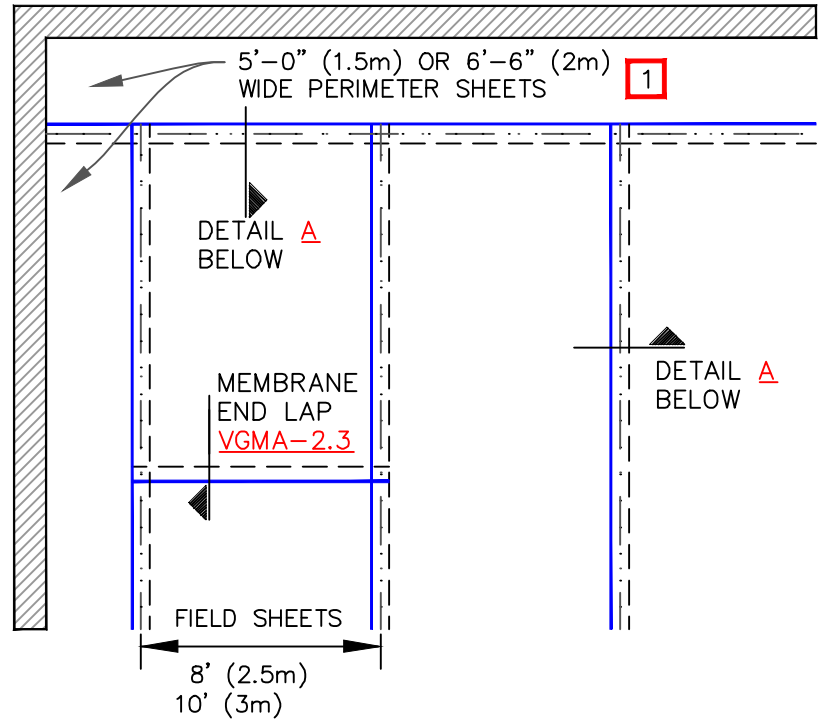

DETAIL A



NOTES:

1. REFER TO VERSICO SPECIFICATIONS FOR REQUIRED NUMBER OF PERIMETER SHEETS, SHEET WIDTH AND MEMBRANE FASTENING DENSITY.
2. HPV FASTENERS AND POLYMER SEAM PLATES ARE REQUIRED OVER STEEL DECKS.

MAXIMUM WARRANTY: 30 YEARS



MECHANICALLY ATTACHED EPDM SECUREMENT - OPTION A

-  → EPDM MEMBRANE
-  → APPROVED SUBSTRATE
-  → SEE NOTE(S)

VersiGard MECHANICALLY ATTACHED (EPDM)

VGMA-2.0A

GUIDELINES FOR ROOF PERIMETER ZONES FOR MECHANICALLY ATTACHED ROOF SYSTEM

 PERIMETER ZONES

SPLIT LEVEL ROOFS

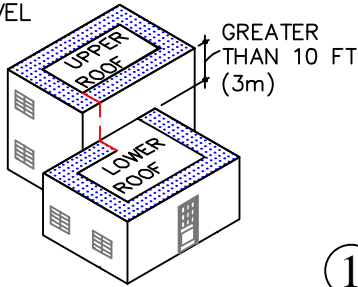

1

SPLIT LEVEL ROOFS

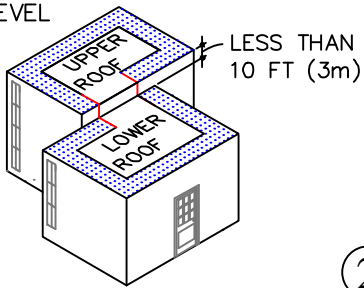

2

CANOPY ROOF

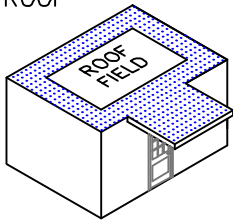

INSTALL PERIMETER SHEETS OVER THE ENTIRE OVERHANG AREA, EXTENDING ONTO THE MAIN ROOF DECK WHEN AT THE SAME LEVEL AS SHOWN.

3

LARGE OPENINGS OR LOADING DOCKS

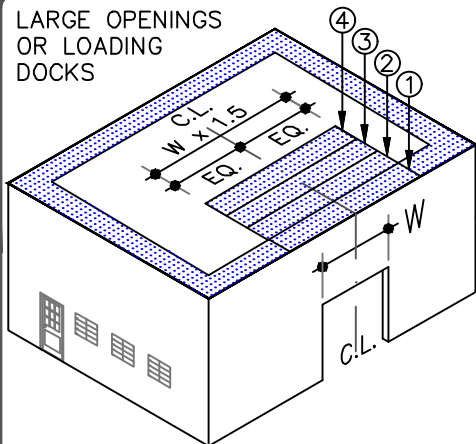

4 PERIMETER SHEETS CENTERED OVER LARGE OPENINGS

4

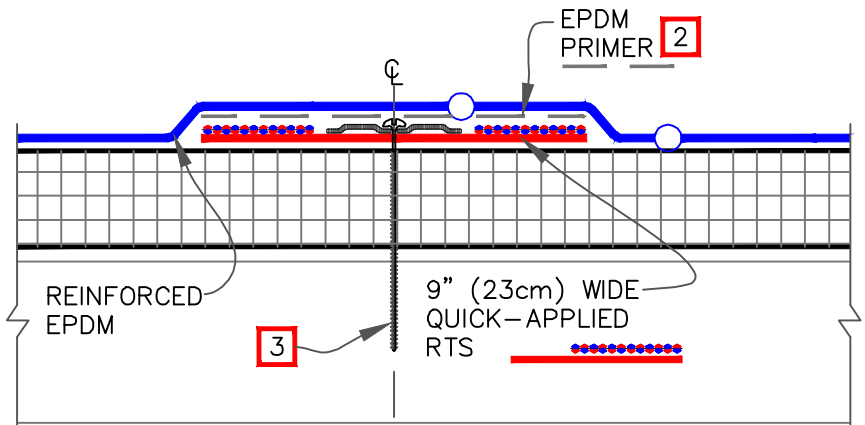
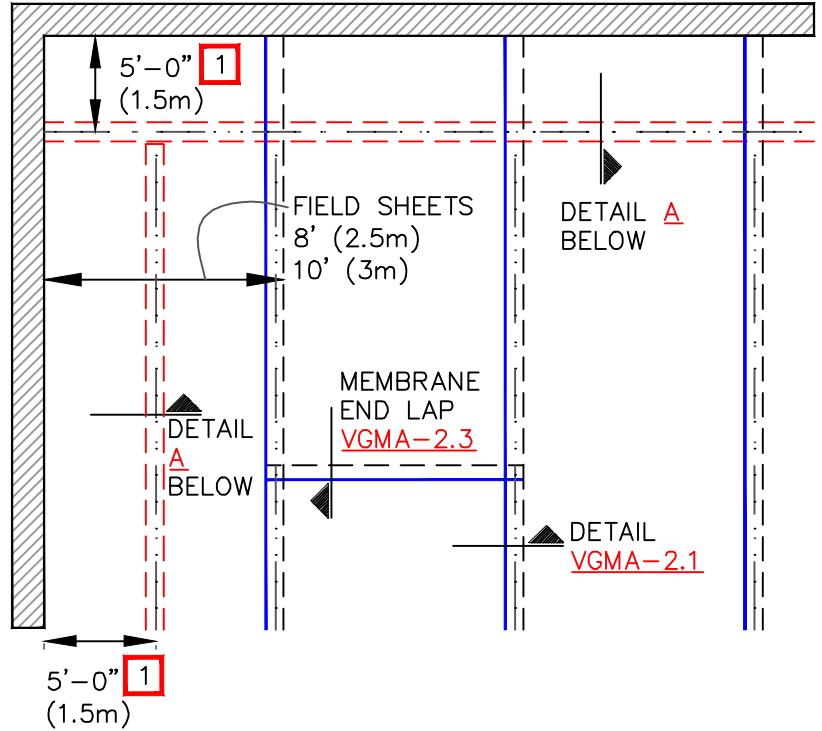

DETAIL A

NOTES:

1. REFER TO VERSICO SPECIFICATIONS FOR REQUIRED NUMBER OF PERIMETER SHEETS, SHEET WIDTH AND MEMBRANE FASTENING DENSITY.
2. EPDM PRIMER MUST BE APPLIED TO THE BACK SIDE OF MEMBRANE SURFACE PRIOR TO ADHERING MEMBRANE TO QUICK-APPLIED RTS.
3. HPV FASTENERS AND POLYMER SEAM PLATES ARE REQUIRED OVER STEEL DECKS.

MAXIMUM WARRANTY: 30 YEARS

RTS (REINFORCED TERMINATION STRIP)



MECHANICALLY ATTACHED EPDM SECUREMENT - OPTION 2 (RTS)

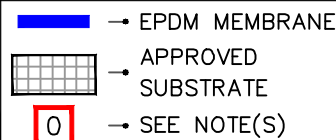

VersiCard MECHANICALLY ATTACHED (EPDM)

VGMA-2.0B

GUIDELINES FOR ROOF PERIMETER ZONES FOR MECHANICALLY ATTACHED ROOF SYSTEM

 PERIMETER ZONES

SPLIT LEVEL ROOFS

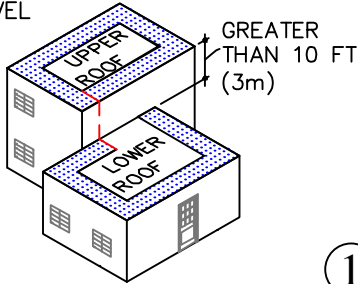

1

SPLIT LEVEL ROOFS

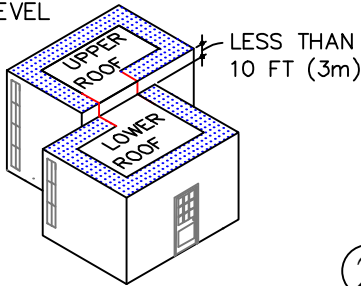

2

CANOPY ROOF

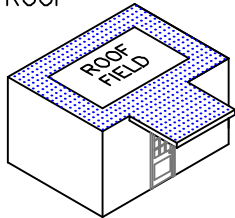

INSTALL PERIMETER SHEETS OVER THE ENTIRE OVERHANG AREA, EXTENDING ONTO THE MAIN ROOF DECK WHEN AT THE SAME LEVEL AS SHOWN.

3

LARGE OPENINGS OR LOADING DOCKS

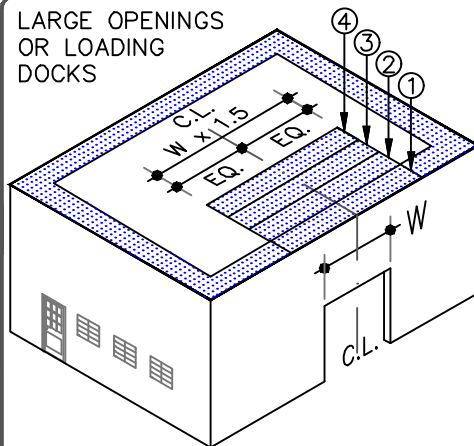

4 PERIMETER SHEETS CENTERED OVER LARGE OPENINGS

4

8' (2.5m) OR 10' (3m) WIDE FIELD SHEET

9" (23cm) RTS STRIP 4

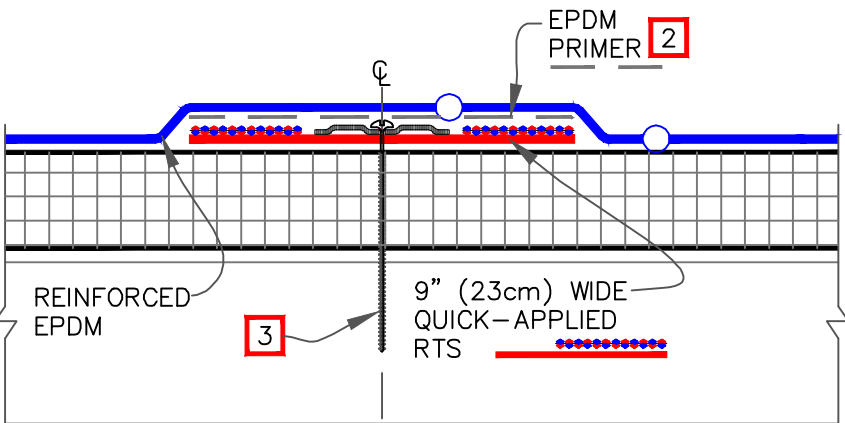
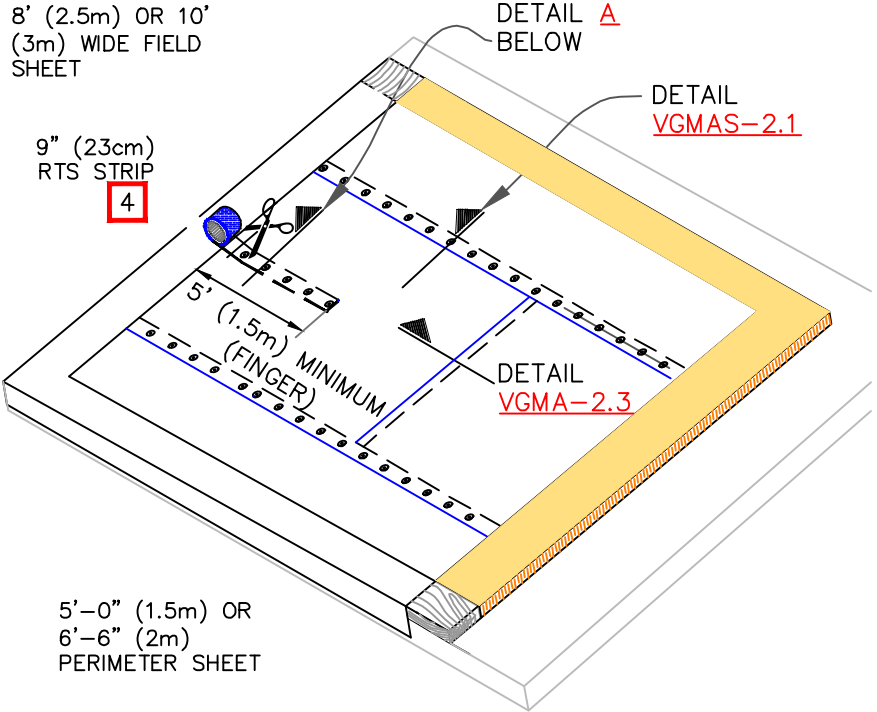

NOTES:

DETAIL A



1. REFER TO VERSICO SPECIFICATIONS FOR REQUIRED NUMBER OF PERIMETER SHEETS, SHEET WIDTH AND MEMBRANE FASTENING DENSITY.
2. EPDM PRIMER MUST BE APPLIED TO THE BACK SIDE OF MEMBRANE SURFACE PRIOR TO ADHERING MEMBRANE TO QUICK-APPLIED RTS.
3. HPV FASTENERS AND POLYMER SEAM PLATES ARE REQUIRED OVER STEEL DECKS.
4. RTS "FINGER" MUST EXTEND THE WIDTH OF THE REQUIRED PERIMETER.

MAXIMUM WARRANTY: 30 YEARS

RTS (REINFORCED TERMINATION STRIP)



MECHANICALLY ATTACHED EPDM SECUREMENT - OPTION 3 (RTS)

-  → EPDM MEMBRANE
-  → APPROVED SUBSTRATE
- 0 → SEE NOTE(S)

VersiCard MECHANICALLY ATTACHED (EPDM)

VGMA-2.0C

6" (15cm) WIDE QA SEAM TAPE SPLICE

6" (15cm) WIDE FACTORY APPLIED TAPE

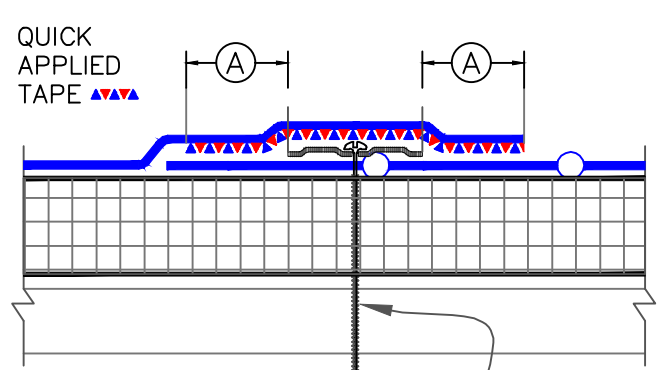
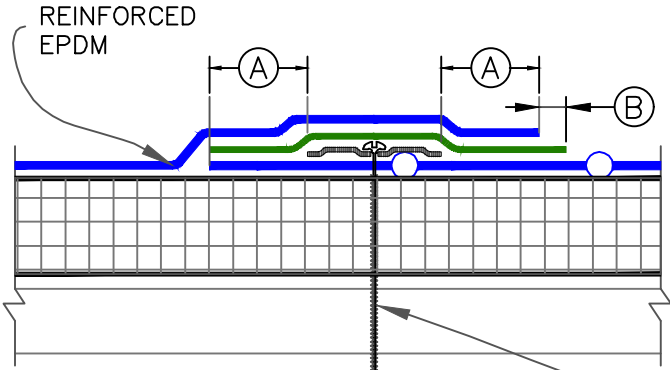

DIMENSIONS	cm	
(A)	2"	5
(B)	1/8"	0.5
	1/2"	1.5

SEAM PLATE & FASTENER POSITIONED OVER PRE-PRINTED BLUE MARKS. FASTEN MAX. 12" (30cm) O.C. **1**

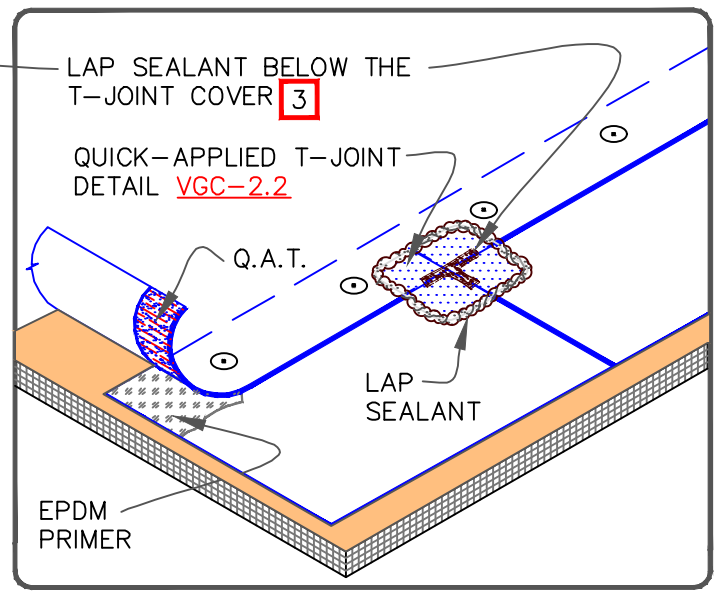
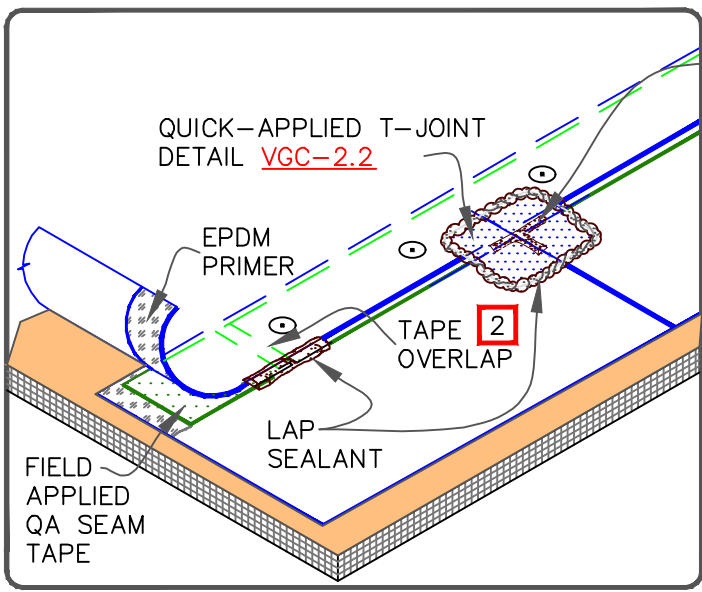

NOTES:

- HPV FASTENERS AND POLYMER SEAM PLATES ARE REQUIRED OVER STEEL DECKS.
- OVERLAP THE ENDS OF FIELD APPLIED QA SEAM TAPE A MINIMUM OF 1" (2.5cm). APPLY LAP SEALANT AT TAPE OVERLAPS 2" (5cm) IN EACH DIRECTION AS SHOWN.
- APPLY LAP SEALANT ALONG THE LEADING EDGE OF THE MEMBRANE SPLICE UNDER THE 6" (15cm) T-JOINT COVER, COVERING THE EXPOSED SPLICE TAPE 1/2" (1.5cm) IN ALL DIRECTIONS FROM THE SPLICE INTERSECTION.
- END LAPS SHALL BE SPLICED USING 3" (7.5cm) WIDE QA SEAM TAPE. REFER TO DETAIL [VGMA-2.2](#).
- LAP SEALANT IS REQUIRED ON CUT EDGES OF REINFORCED EPDM MEMBRANE.

MAXIMUM WARRANTY: 25 YEARS



MECHANICALLY ATTACHED EPDM MEMBRANE SPLICE

- EPDM MEMBRANE
- APPROVED SUBSTRATE
- SEE NOTE(S)

VersiCard MECHANICALLY ATTACHED (EPDM)

VGMA-2.1

FIELD APPLIED QA SEAM TAPE

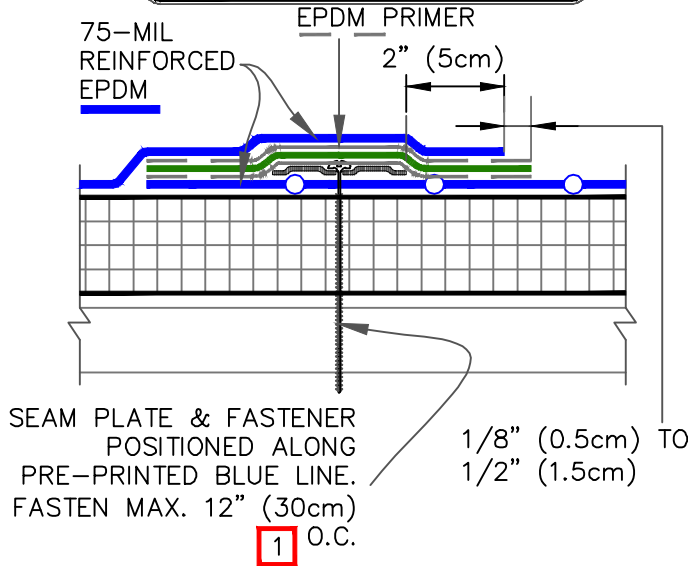

QUICK APPLIED SEAM TAPE

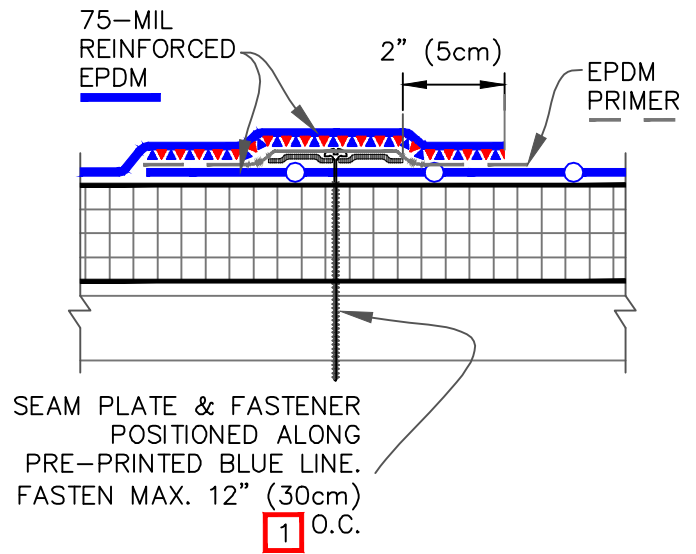

6" (15cm) AND 12" (30cm) QUICK-APPLIED T-JOINT DETAIL PER [VGMA-2.2A](#)

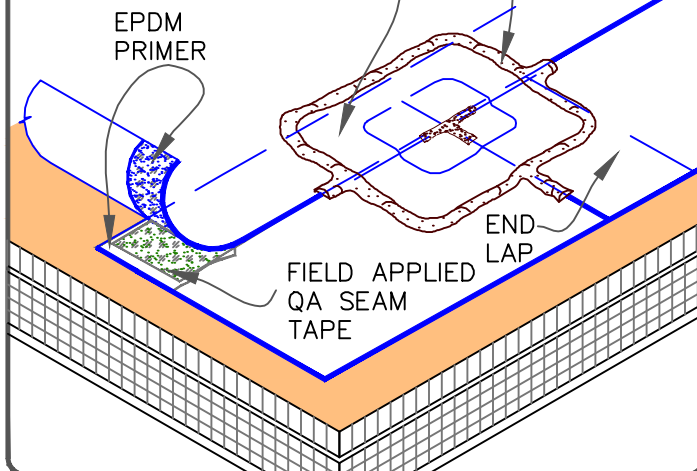

6" (15cm) AND 12" (30cm) QUICK-APPLIED T-JOINT DETAIL PER [VGMA-2.2A](#)

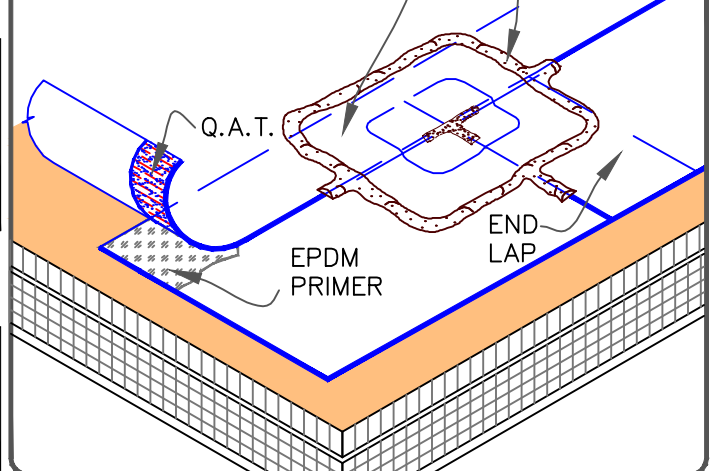

NOTES:

1. HPV FASTENERS AND POLYMER SEAM PLATES ARE REQUIRED OVER STEEL DECKS.
2. END LAPS SHALL BE SPLICED USING 6" (15cm) WIDE QA SEAM TAPE. REFER TO DETAIL [VGC-2.1A](#).
3. OVERLAP THE ENDS OF FIELD APPLIED QA SEAM TAPE A MINIMUM OF 1" (2.5cm). APPLY LAP SEALANT AT TAPE OVERLAPS 2" (5cm) IN ALL DIRECTIONS.
4. LAP SEALANT IS REQUIRED ON CUT EDGES OF REINFORCED EPDM MEMBRANE.

MAXIMUM WARRANTY: 30 YEARS



MECHANICALLY ATTACHED EPDM MEMBRANE SPLICE (30 YEAR WARRANTIES)

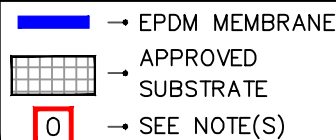

VersiCard MECHANICALLY ATTACHED (EPDM)

VGMA-2.1A

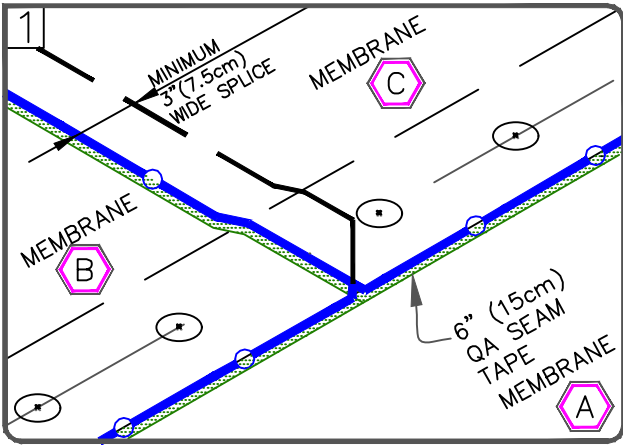

POSITION MEMBRANE TO ALLOW AN APPROXIMATE 7" (17.5cm) OVERLAP ALONG THE LENGTH OF THE MEMBRANE & 4" (10cm) AT END LAPS. THE PRE-MARKED LINE ON THE MEMBRANE EDGE CAN BE USED AS A GUIDE FOR TAPE PLACEMENT.

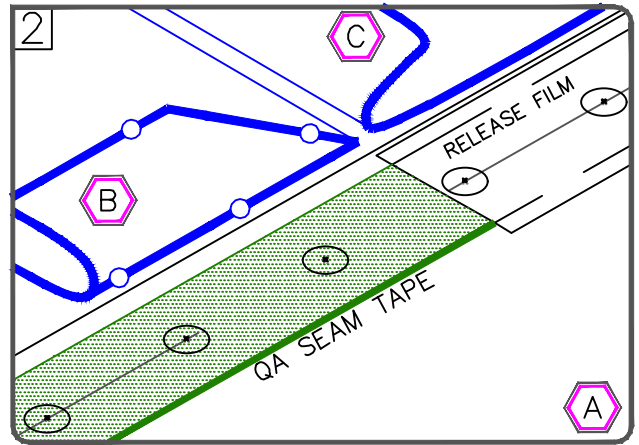

FOLD SHEETS BACK AS SHOWN. APPLY EPDM PRIMER TO THE SPLICE AREA ON BOTH SURFACES AND ALLOW TO FLASH-OFF. APPLY QA SEAM TAPE WITH RELEASE FILM ALIGNED WITH PRE-MARKED LINE.

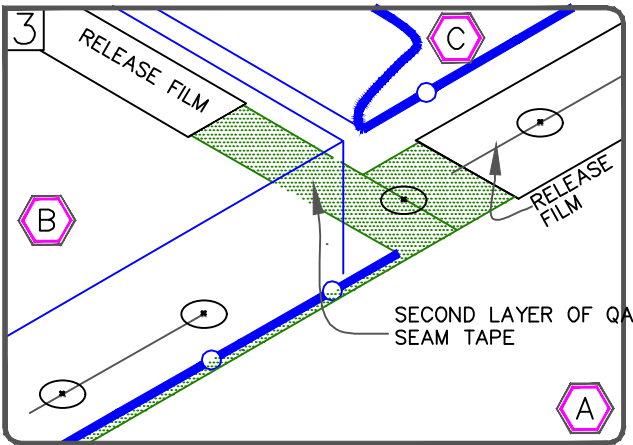

SPLICE SHEET B TO SHEET A AND APPLY SECOND PIECE OF QA SEAM TAPE BETWEEN SHEET B AND C. TRIM RELEASE FILM AS SHOWN.

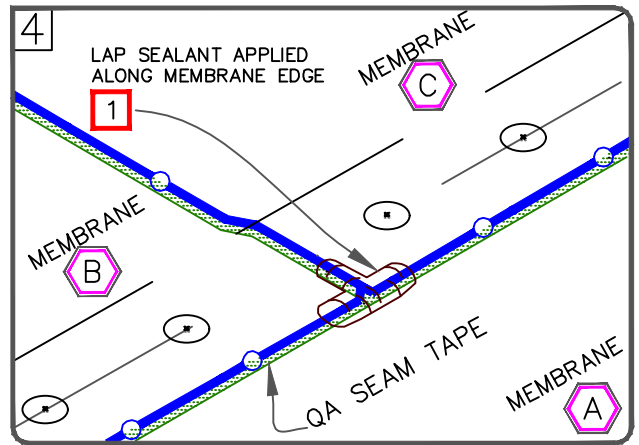

SPLICE SHEET C TO SHEET A AND B, PRESS TOP SHEET ONTO BOTTOM SHEET USING HAND PRESSURE TOWARDS THE OUTER EDGE OF THE SPLICE AND ROLL THE SPLICE AREA WITH A 2" (5cm) WIDE STEEL ROLLER.

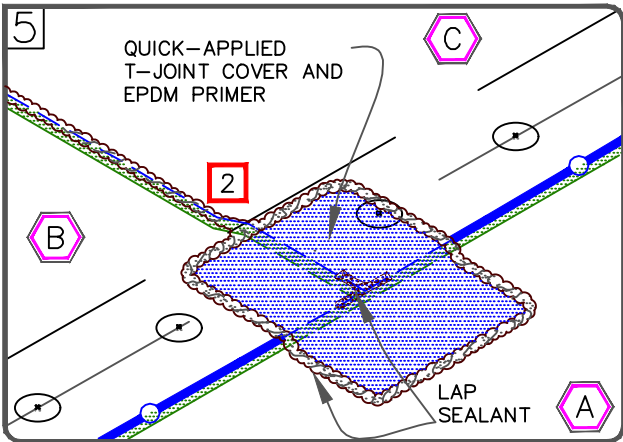

APPLY QUICK-APPLIED T-JOINT COVER OR 6" (15cm) WIDE SECTION OF QUICK-APPLIED UNCURED FLASHING CENTERED OVER THE INTERSECTING POINT OF THE LEADING EDGES OF THE FIELD SPLICE INTERSECTION AS SHOWN.



MAXIMUM WARRANTY: 25 YEARS

NOTES:

1. APPLY LAP SEALANT ALONG THE EDGE OF THE MEMBRANE SPLICE (BELOW THE 6" (15cm) T-JOINT COVER) COVERING THE EXPOSED SPLICE TAPE 1/2" (1.5cm) IN EACH DIRECTION FROM THE SPLICE INTERSECTION.
2. APPLY LAP SEALANT AT CUT EDGES OF REINFORCED MEMBRANE AND TAPE OVERLAPS. REFER TO [DETAIL VGMA-2.1](#)



MECHANICALLY ATTACHED EPDM MEMBRANE SPLICE INTERSECTION

-  → EPDM MEMBRANE
-  → APPROVED SUBSTRATE
-  → SEE NOTE(S)

VersiGard MECHANICALLY ATTACHED (EPDM)

VGMA-2.2

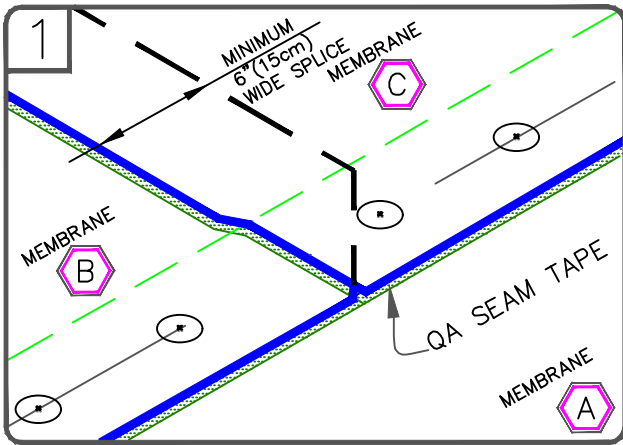

POSITION MEMBRANE TO ALLOW AN APPROXIMATE 7" (17.5cm) OVERLAP. THE PRE-MARKED LINE ON THE MEMBRANE EDGE CAN BE USED AS A GUIDE FOR TAPE PLACEMENT.

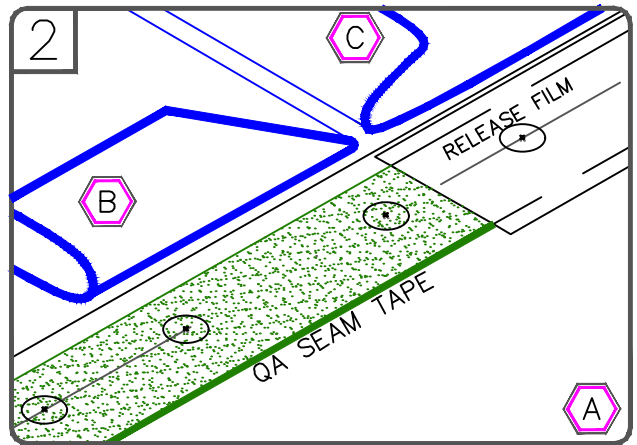

FOLD SHEETS BACK AS SHOWN. APPLY EPDM PRIMER TO THE SPLICE AREA ON BOTH SURFACES AND ALLOW TO FLASH-OFF. APPLY QA SEAM TAPE WITH RELEASE FILM ALIGNED WITH PRE-MARKED LINE.

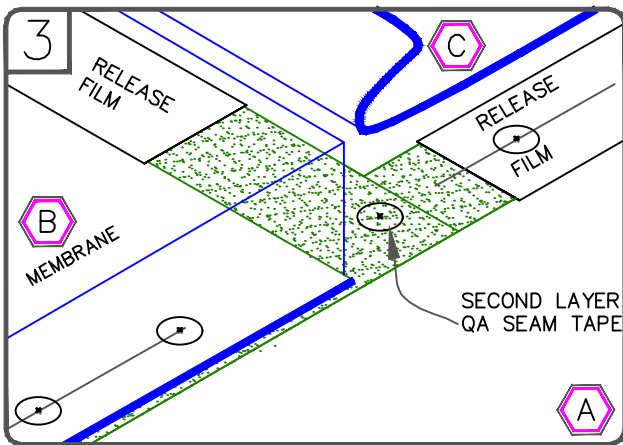

SPLICE SHEET B TO SHEET A AND APPLY SECOND PIECE OF QA SEAM TAPE BETWEEN SHEET B AND C. TRIM RELEASE FILM AS SHOWN.

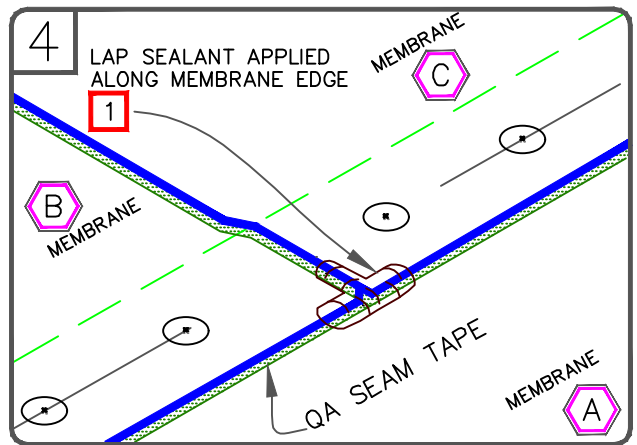

SPLICE SHEET C TO SHEET A AND B, PRESS TOP SHEET ONTO BOTTOM SHEET USING HAND PRESSURE TOWARDS THE OUTER EDGE OF THE SPLICE AND ROLL THE SPLICE AREA WITH A 2" (5cm) WIDE STEEL ROLLER.

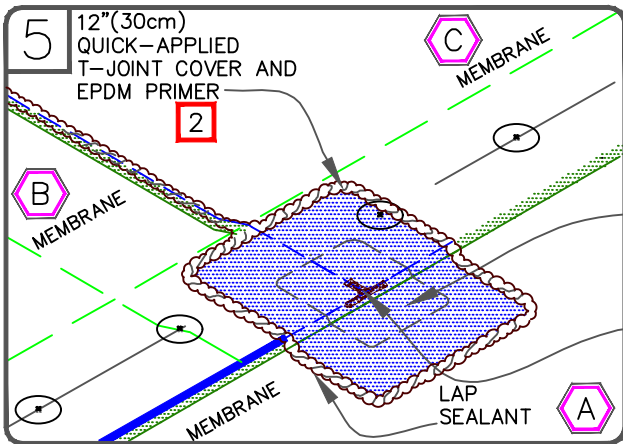

APPLY 6" (15cm) QUICK-APPLIED T-JOINT COVER AND 12" (30cm) QUICK-APPLIED T-JOINT COVER OR QUICK-APPLIED UNCURED CENTERED OVER THE INTERSECTING POINT OF THE LEADING EDGES OF THE FIELD SPLICE INTERSECTION AS SHOWN.

MAXIMUM WARRANTY: 30 YEARS

6" (15cm) QUICK-APPLIED T-JOINT COVER AND EPDM PRIMER



LAP SEALANT BELOW THE 6" (15cm) T-JOINT COVER

NOTES:

1. APPLY LAP SEALANT ALONG THE EDGES OF THE MEMBRANE SPLICE COVERING THE EXPOSED SPLICE TAPE 1/2" (1.5cm) IN EACH DIRECTION FROM THE SPLICE INTERSECTION.
2. APPLY LAP SEALANT AT CUT EDGES OF REINFORCED MEMBRANE AND TAPE OVER LAPS.



MECHANICALLY ATTACHED EPDM MEMBRANE SPLICE INTERSECTION (30 YEAR WARRANTIES)

 → EPDM MEMBRANE
 → APPROVED SUBSTRATE
 → SEE NOTE(S)

VersiGard MECHANICALLY ATTACHED (EPDM)
 VGMA-2.2A

MIN. 3" (7.5cm) WIDE
QA SEAM TAPE WITH
EPDM PRIMER

1/8" (0.5cm) MIN TO
1/2" (1.5cm) MAX.

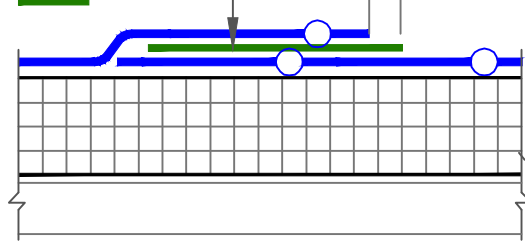

SEE 3D DETAILS BELOW

(A)

UP TO 25-YEAR WARRANTY

MIN. 6" (15cm) WIDE QA SEAM TAPE
WITH EPDM PRIMER

1/8" (0.5cm) MIN TO
1/2" (1.5cm) MAX.

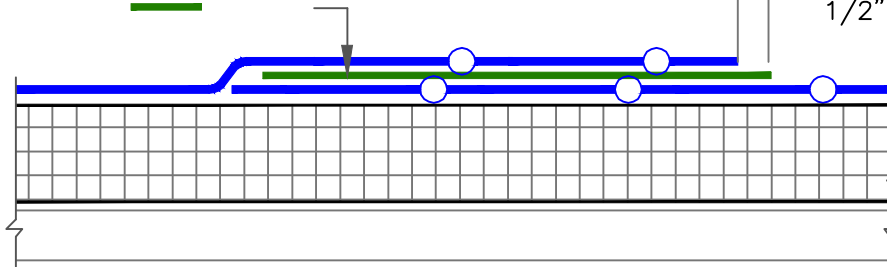

SEE 3D DETAILS BELOW

(B)

UP TO 30-YEAR WARRANTY

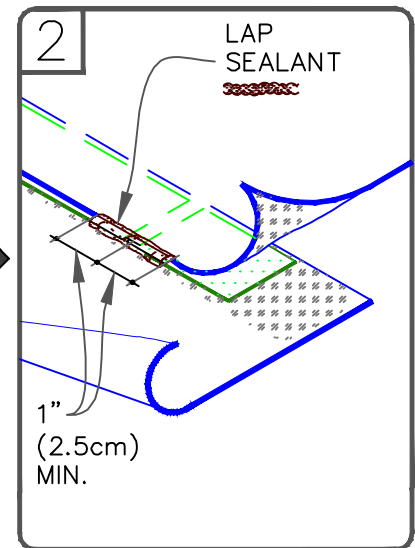
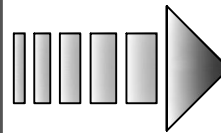
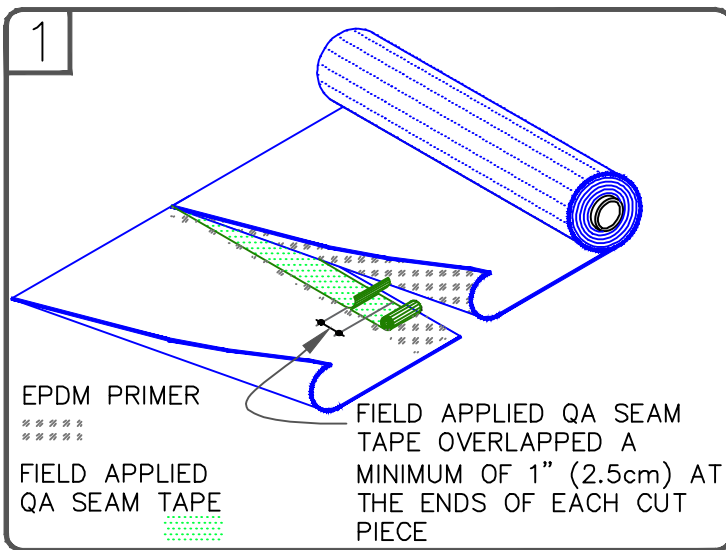



NOTES:

1. APPLY EPDM PRIMER TO THE MEMBRANE SURFACES PRIOR TO INSTALLING QUICK-APPLIED FLASHING.
2. LAP SEALANT IS REQUIRED ON CUT EDGES OF REINFORCED EPDM MEMBRANE.

MAXIMUM WARRANTY: 30 YEARS



END LAP SPLICE

-  → EPDM MEMBRANE
-  → APPROVED SUBSTRATE
-  → SEE NOTE(S)

VersiCard MECHANICALLY ATTACHED (EPDM)

VGMA-2.3

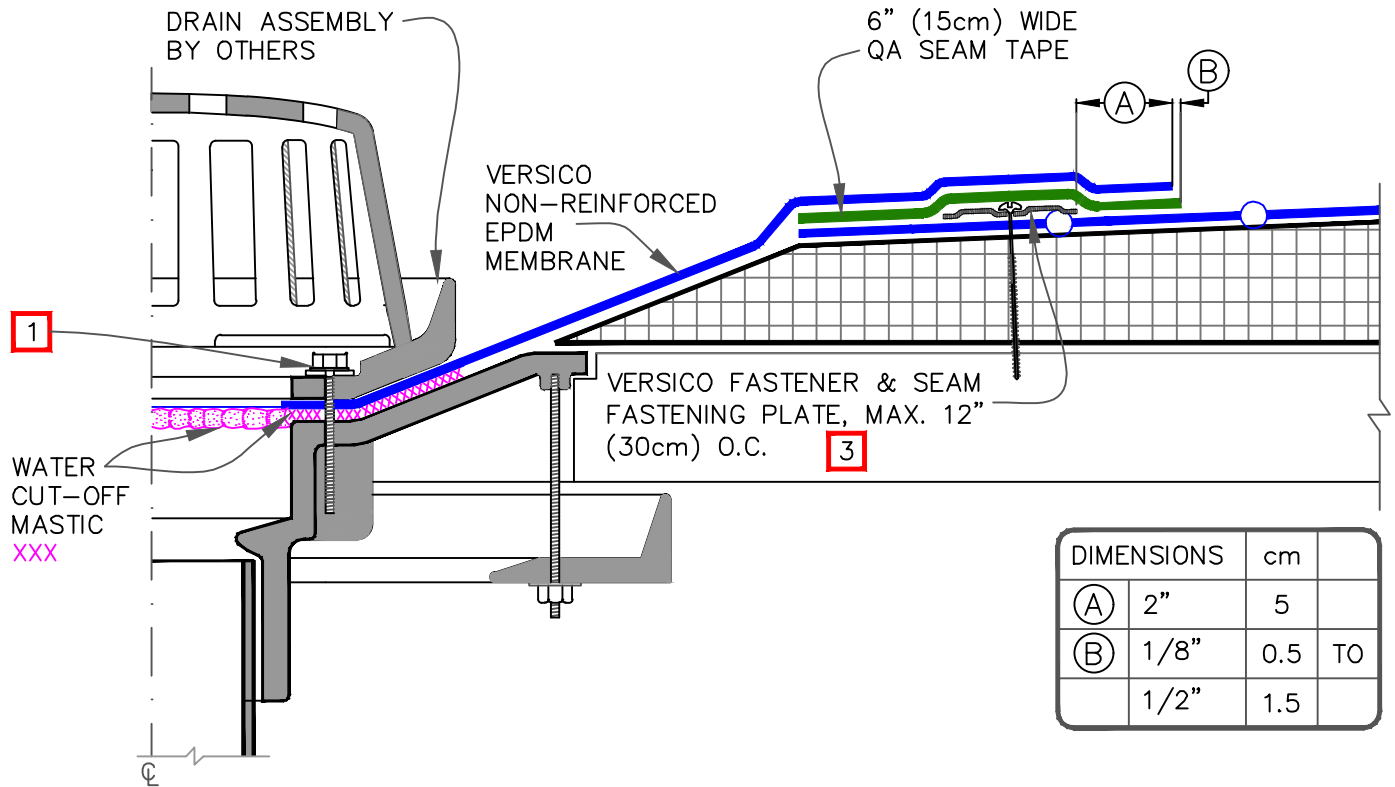

NOTES:

1. ALL BOLTS OR CLAMPS MUST BE IN PLACE TO PROVIDE CONSTANT COMPRESSION ON WATER CUT-OFF MASTIC.
2. REMOVE EXISTING LEAD, FLASHING MATERIAL & ENSURE THE DRAIN RING IS COMPLETELY CLEAN DOWN TO BARE METAL.
3. HPV FASTENERS AND POLYMER SEAM PLATES ARE REQUIRED OVER STEEL DECKS.
4. THE HOLE IN THE MEMBRANE SHALL EXCEED THE DIAMETER OF THE DRAIN PIPE, BUT SHALL BE NO LESS THAN 1/2" (1.5cm) FROM THE ATTACHMENT POINTS OF THE DRAIN CLAMPING RING.
5. ROOF DRAIN SIZE AND NUMBER OF DRAINS SHALL BE IN ACCORDANCE WITH THE LOCAL CODES.

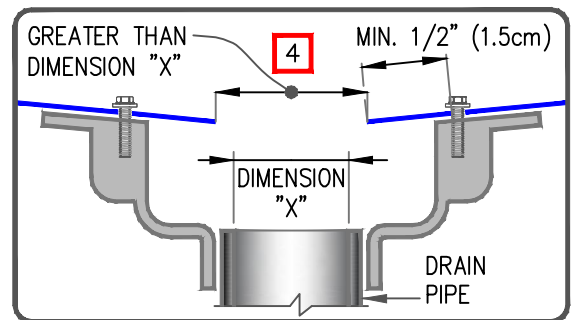

MAXIMUM WARRANTY: 30 YEARS



ROOF DRAIN WITH SUMP
GREATER THAN 3" PER
FOOT

→ EPDM MEMBRANE

→ APPROVED SUBSTRATE

0 → SEE NOTE(S)

VersiGard MECHANICALLY ATTACHED (EPDM)

VGMA-6.0

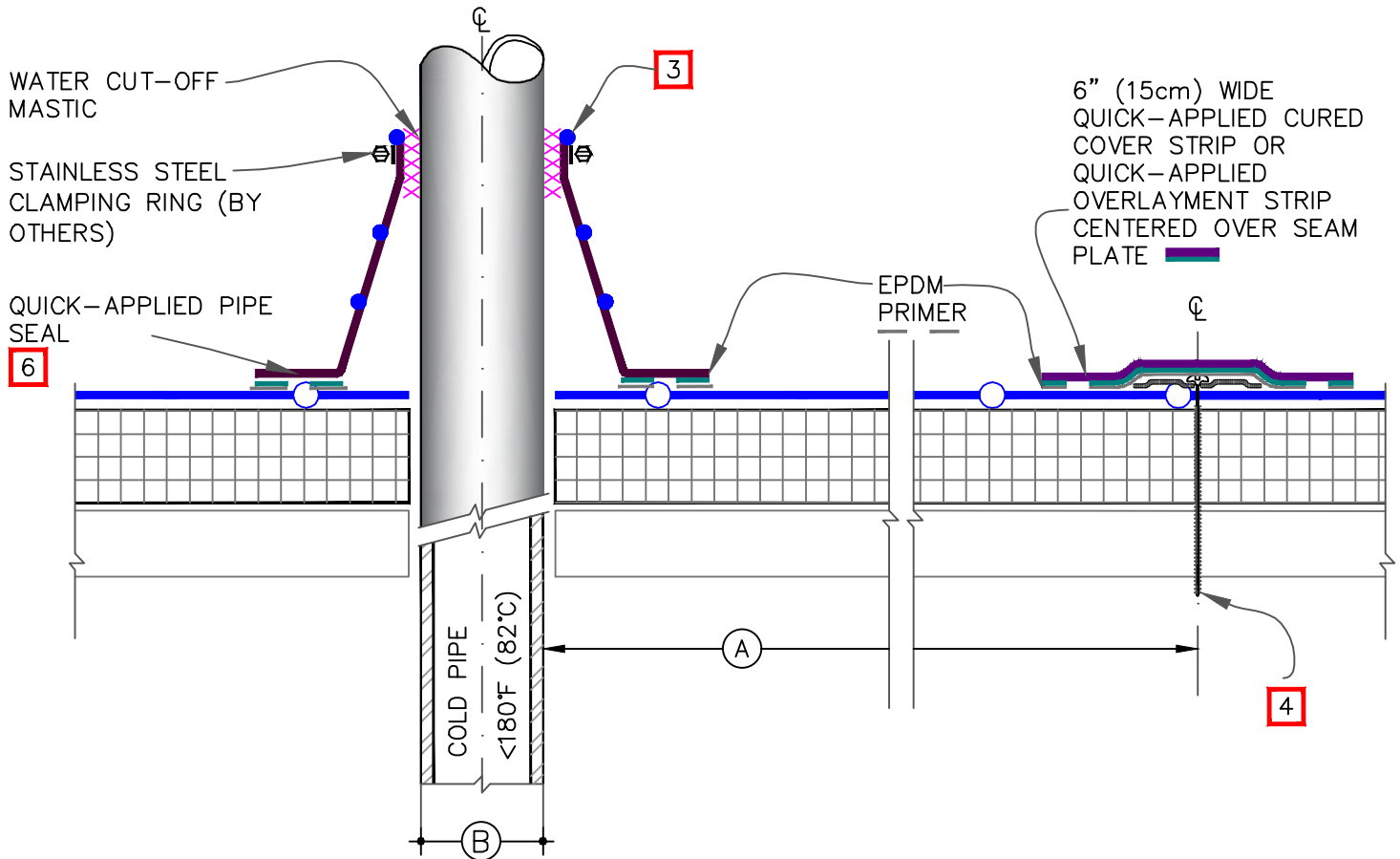

NOTES:



1. REMOVE ALL LEAD AND OTHER FLASHING BEFORE INSTALLING PIPE SEAL.
2. TEMPERATURE OF PIPE MUST NOT EXCEED 180°F (82°C).
3. PRE-MOLDED PIPE SEAL MUST HAVE RIB INTACT AT THE TOP EDGE REGARDLESS OF PIPE DIAMETER.
4. INSTALL A MINIMUM OF 4 SEAM PLATES FOR PIPES WITH A DIAMETER UP TO 6" (15cm). ADDITIONAL SEAM PLATES WILL BE REQUIRED FOR PIPES GREATER THAN 6" (15cm) IN DIAMETER AND SHALL BE SPACED 12" (30cm) ON CENTER MAXIMUM.
5. HPV FASTENERS AND POLYMER SEAM PLATES ARE REQUIRED OVER STEEL DECKS.
6. DECK FLANGES OF THE QUICK-APPLIED PIPE SEAL SHALL NOT BE OVERLAPPED, CUT OR APPLIED OVER ANY ANGLE CHANGE.

DIMENSIONS	cm	
(A) 6"	15	TO
12"	30	
(B) 1/2"	1.5	TO
6"	15	

MAXIMUM WARRANTY: 25 YEARS



QUICK-APPLIED PIPE SEAL

 → EPDM MEMBRANE
 → APPROVED SUBSTRATE
 → SEE NOTE(S)

VersiCard MECHANICALLY ATTACHED (EPDM)

VGMA-8.1

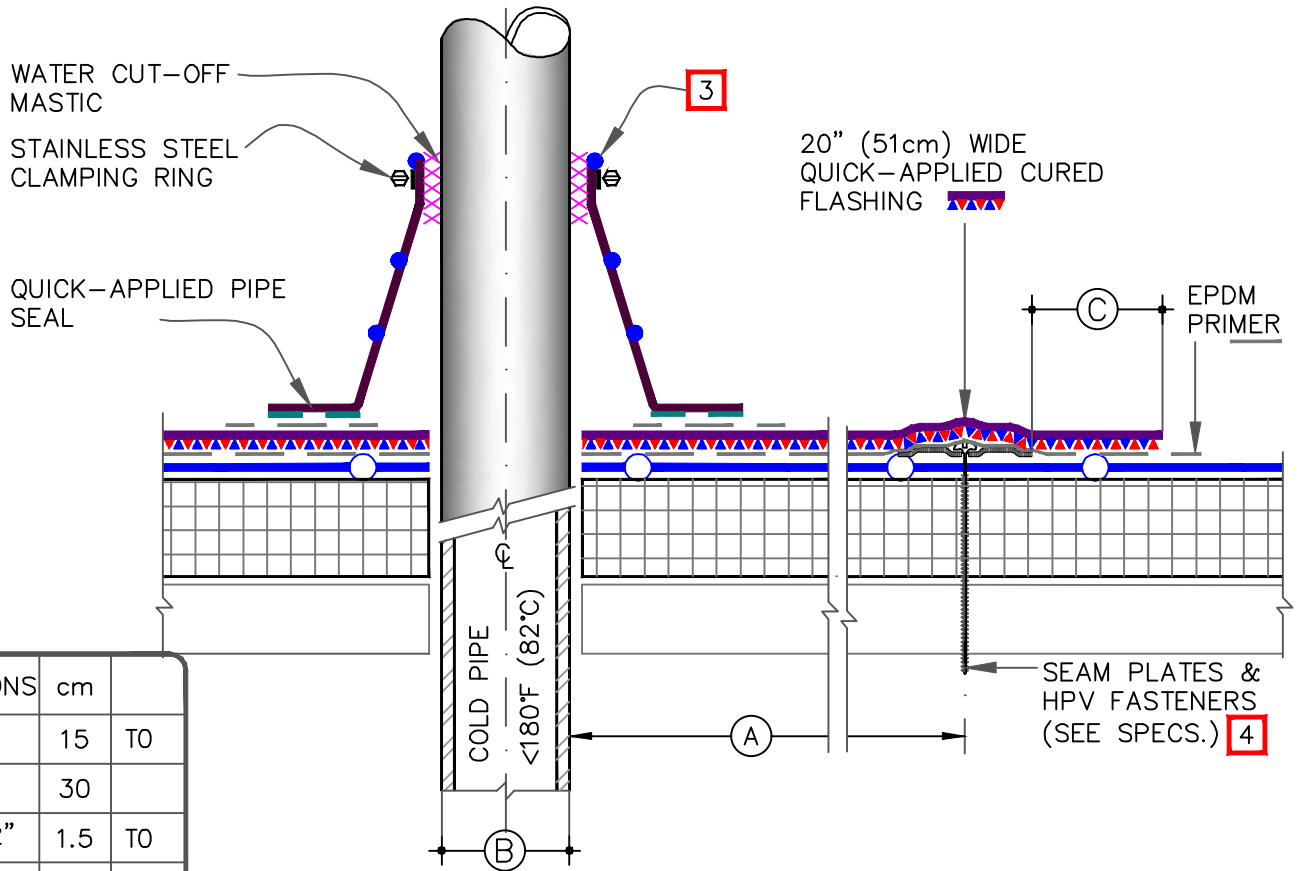

DIMENSIONS	cm	
(A)	6"	15 TO
	12"	30
(B)	1/2"	1.5 TO
	6"	15
(C)	2"	5

NOTES:

1. REMOVE ALL LEAD AND OTHER FLASHING BEFORE INSTALLING PIPE SEAL.
2. TEMPERATURE OF PIPE MUST NOT EXCEED 180°F (82°C).
3. PRE-MOLDED PIPE SEAL MUST HAVE RIB INTACT AT THE TOP EDGE REGARDLESS OF PIPE DIAMETER.
4. INSTALL A MIN. OF 4 FASTENERS FOR PIPES WITH OUTSIDE DIAMETER <math><6''</math> (15cm). SEE DETAIL [VGMA-8.2](#) WITH OPTION FOR WIDER PIPES.
5. DECK FLANGES OF THE QUICK-APPLIED PIPE SEAL SHALL NOT BE OVERLAPPED, CUT OR APPLIED OVER ANY ANGLE CHANGE.

MAXIMUM WARRANTY: 30 YEARS

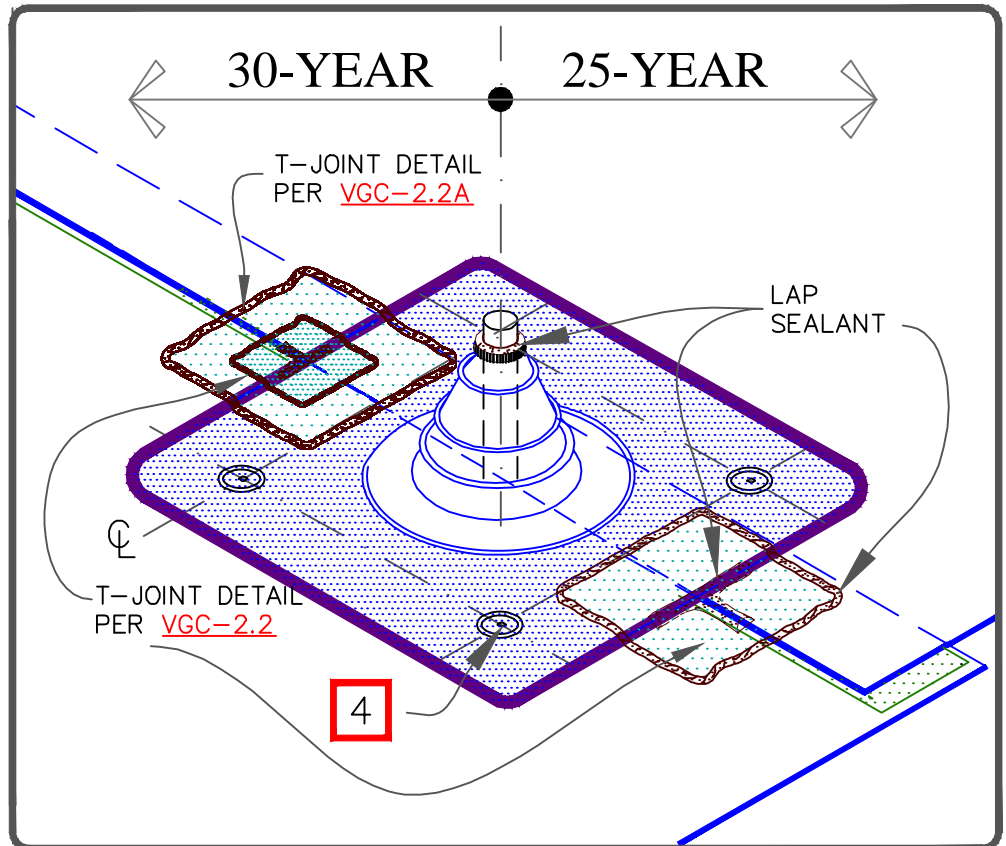

QUICK-APPLIED PIPE SEAL WITH 20 INCH QUICK-APPLIED CURED FLASHING

█ → EPDM MEMBRANE
 → APPROVED SUBSTRATE
0 → SEE NOTE(S)

VersiGard MECHANICALLY ATTACHED (EPDM)

VGMA-8.1A

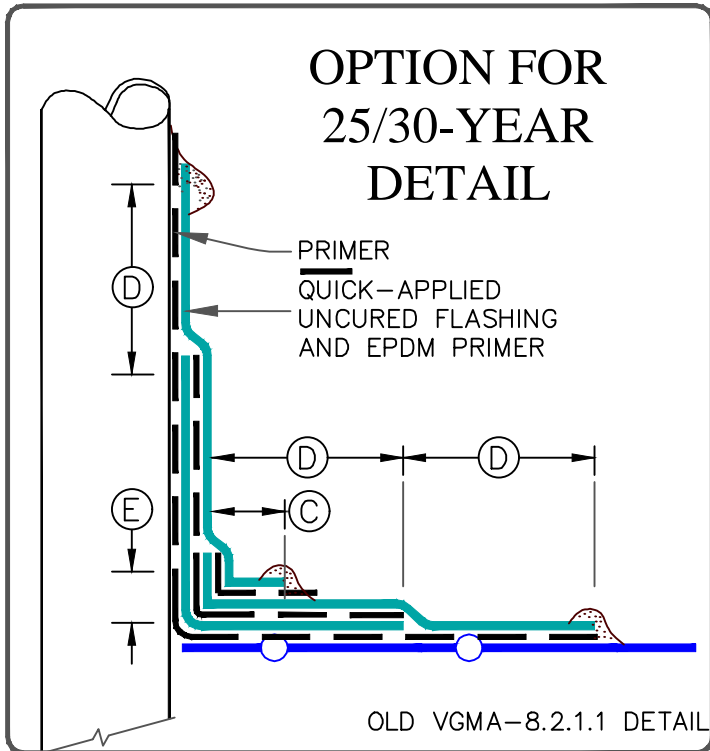
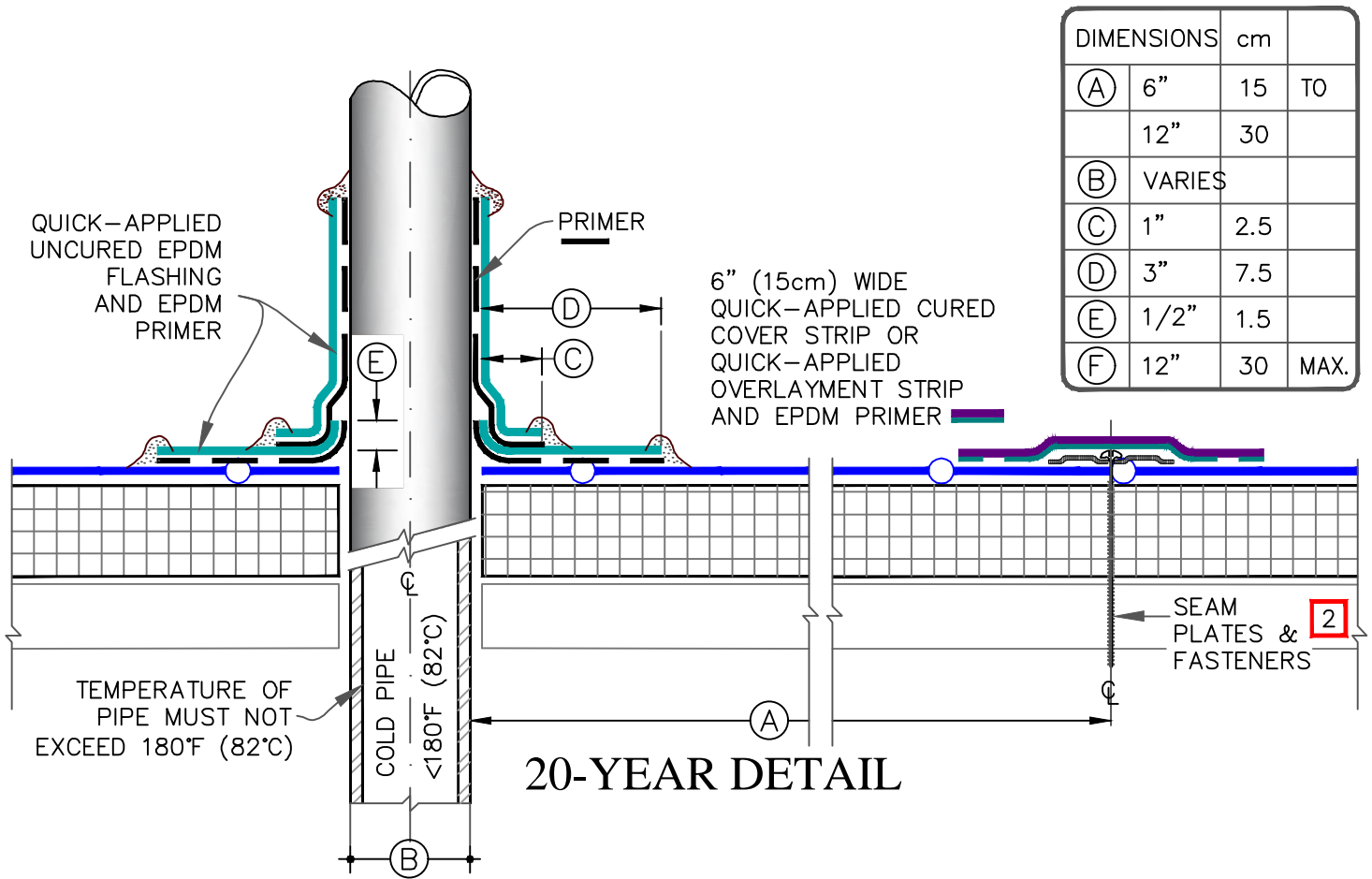

NOTES:

1. REMOVE ALL LEAD AND OTHER FLASHING BEFORE INSTALLING QA UNCURED EPDM FLASHING.
2. HPV FASTENERS AND POLYMER SEAM PLATES ARE REQUIRED OVER STEEL DECKS.
3. FOR STRUCTURAL STEEL TUBING GREATER THAN 12" ACROSS USE VGC-5 DETAILS.

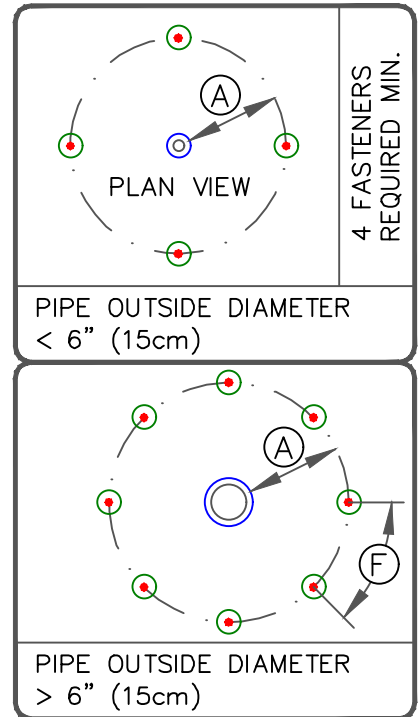

MAXIMUM WARRANTY: SEE EACH DETAIL



FIELD FABRICATED PIPE WRAP

- EPDM MEMBRANE
- APPROVED SUBSTRATE
- SEE NOTE(S)

VersiGard MECHANICALLY ATTACHED (EPDM)

VGMA-8.2

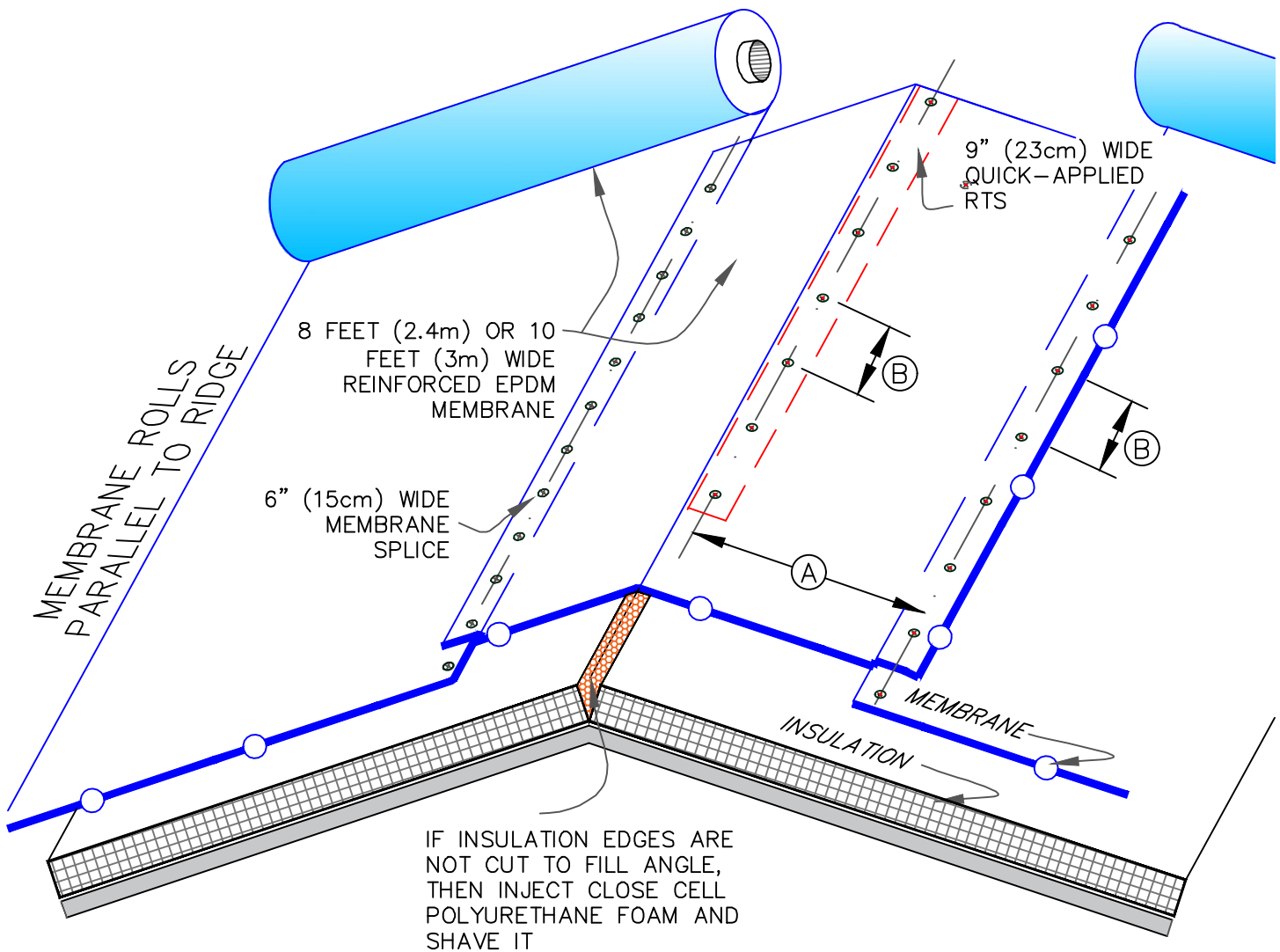

NOTES:

1. RIDGE MEMBRANE ATTACHMENT IS ONLY REQUIRED WHEN ROOF SLOPE EXCEEDS 3" TO THE HORIZONTAL FOOT (7.5cm/30cm).
2. REINFORCED EPDM MEMBRANE SHALL BE INSTALLED PARALLEL WITH RIDGE LINE (WITH MEMBRANE CENTERED OVER THE RIDGE LINE) AS SHOWN.
3. FOR PROPER MEMBRANE ATTACHMENT AND SPLICING, [REFER TO APPLICABLE VGMA-2 DETAIL](#)
4. REFER TO VERSICO SPECIFICATIONS FOR REQUIRED NUMBER OF PERIMETER SHEETS, SHEET WIDTH AND MEMBRANE FASTENING DENSITY.
5. HPV FASTENERS AND POLYMER SEAM PLATES ARE REQUIRED OVER STEEL DECKS.
6. AS AN OPTION, 9" (23cm) WIDE QUICK-APPLIED RTS MAY BE USED BENEATH EPDM FIELD SHEETS FOR PERIMETER SECUREMENT.

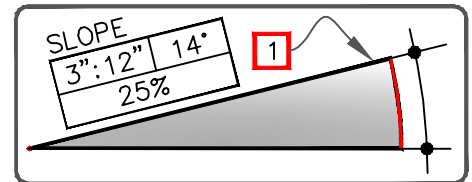

DIMENSIONS		cm	
Ⓐ	3'-6"	110	MIN.
	4'-6"	140	MAX.
Ⓑ	12" O.C.	30	MAX.

MAXIMUM WARRANTY: 30 YEARS



RIDGE MEMBRANE ATTACHMENT

- EPDM MEMBRANE
- APPROVED SUBSTRATE
- SEE NOTE(S)

VersiCard MECHANICALLY ATTACHED (EPDM)

VGMA-22

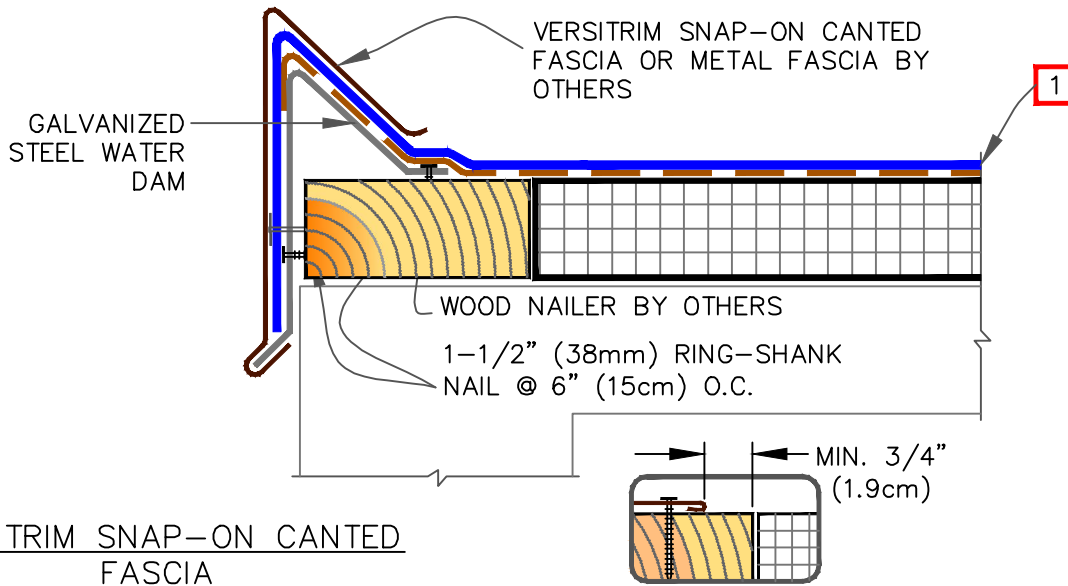

VERSITRIM SNAP-ON CANTED FASCIA

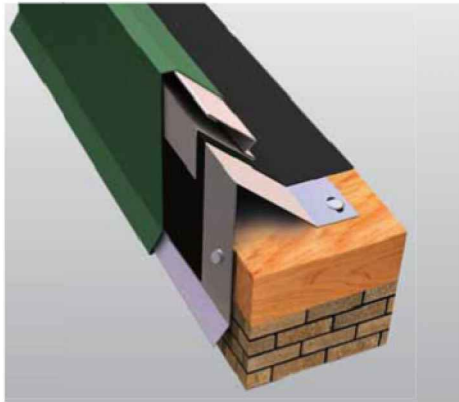

NOTES:

1. MAXIMUM MEMBRANE THICKNESS GOING OVER THE WATER DAM IS 60-MIL. FOR THICKER MEMBRANES, RUN FIELD SHEET UNDER THE WATER DAM AND STRIP-IN WITH MAXIMUM 60-MIL MEMBRANE.
2. USE [VGMA-1.1](#) FOR MECHANICALLY ATTACHED SYSTEMS AND [VGB-1.1](#) FOR BALLASTED SYSTEMS.

AT CORNERS, 6" (15cm) WIDE QUICK-APPLIED RTS MUST BE INSTALLED 12" (30cm) MAXIMUM FROM THE BASE OF THE WATER DAM AND EXTEND 36" (90cm) MINIMUM IN EACH DIRECTION.

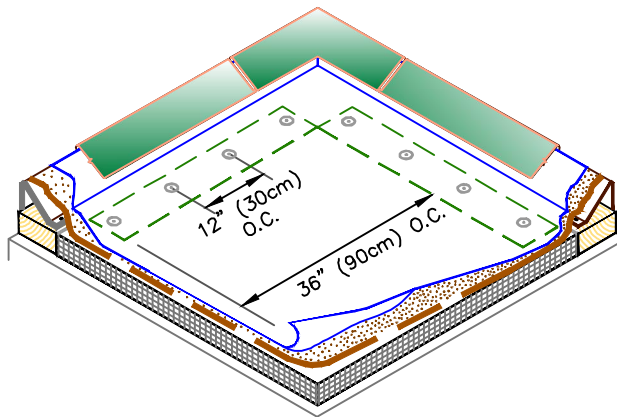

CORNER REINFORCEMENT

QUICK-APPLIED T-JOINT COVER AND EPDM PRIMER

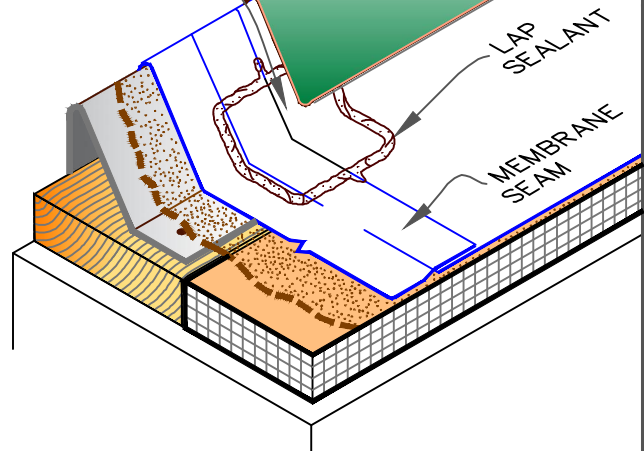

MEMBRANE SEAM AT EDGE

MAXIMUM WARRANTY: 25 YEARS



VERSITRIM SNAP-ON CANTED FASCIA

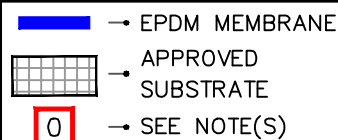

VersiGard COMMON DETAILS (EPDM)

VGC-1.1

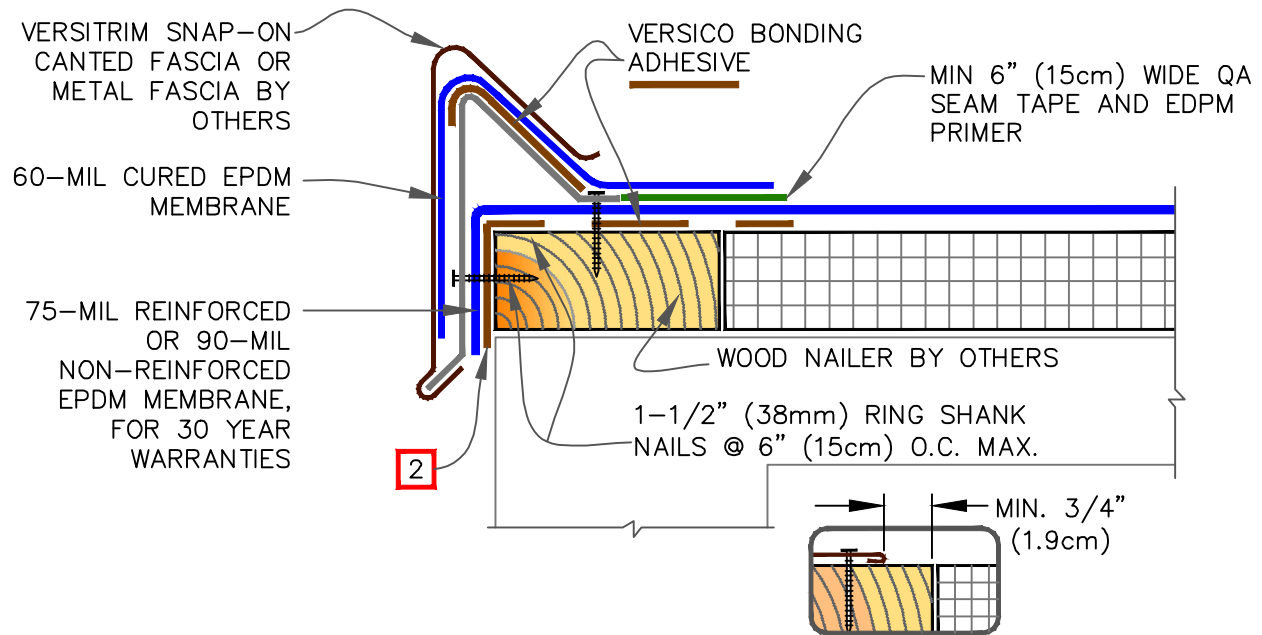

NOTES:

1. FIELD SPLICES AT THE ANGLE CHANGE SHALL BE OVERLAID WITH EPDM PRIMER AND TWO LAYERS OF QUICK-APPLIED UNCURED FLASHING. PER DETAIL [VGC-2.3.](#)
2. WHEN AN AIR/VAPOR BARRIER IS NOT SPECIFIED, THE ROOF MEMBRANE SHALL BE ADHERED OVER PERIMETER WOOD NAILER ALONG EDGES TO PREVENT AIR INFILTRATION ALONG EDGING, REGARDLESS OF ASSEMBLY TYPE (BALLASTED, ADHERED AND MECHANICALLY ATTACHED).

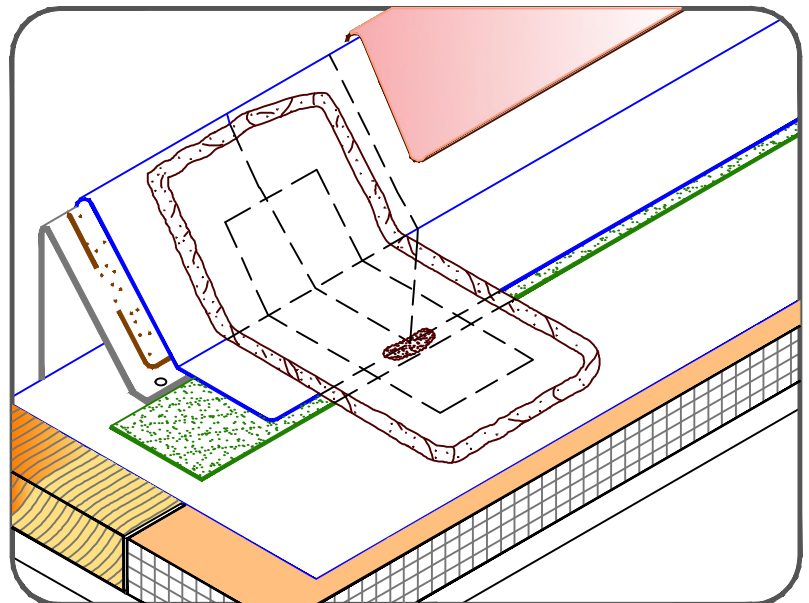

MAXIMUM WARRANTY: 30 YEARS



VERSITRIM SNAP-ON CANTED FASCIA (30 YEAR WARRANTIES)

→ EPDM MEMBRANE

→ APPROVED SUBSTRATE

→ SEE NOTE(S)

VersiGard COMMON DETAILS (EPDM)

VGC-1.1A

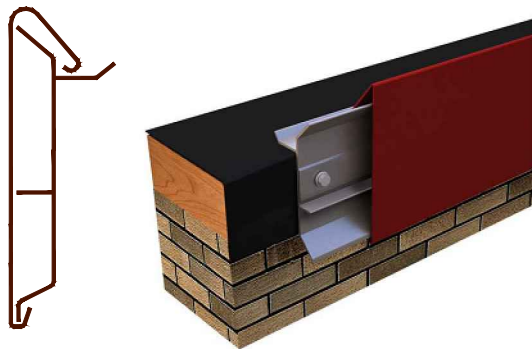
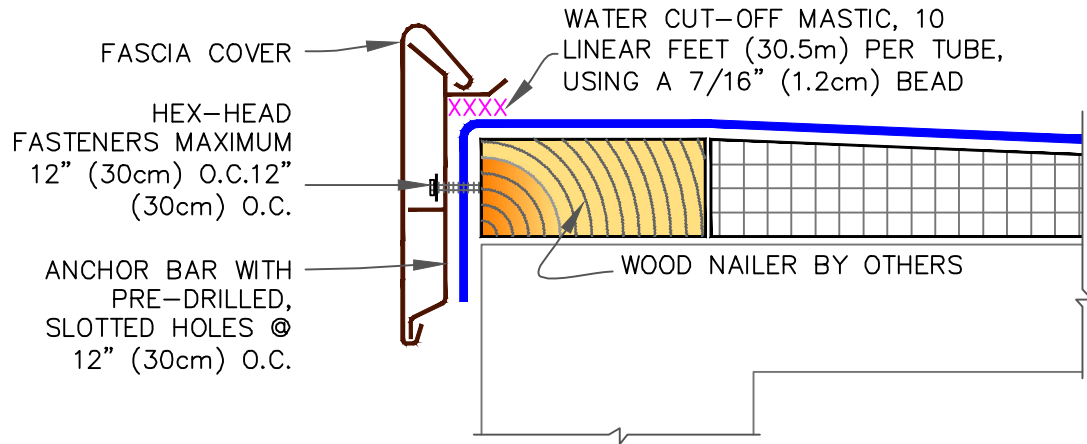

VERSITRIM EX SNAP-ON FASCIA



VERSITRIM SNAP-ON FASCIA

NOTES:

1. IF INCIDENTAL/TEMPORARY PONDED WATER IS EXPECTED, THE VERSITRIM MUST BE ELEVATED AND SCUPPERS PROVIDED FOR DRAINAGE.
2. ENSURE ROOF SLOPES AWAY FROM VERSITRIM.

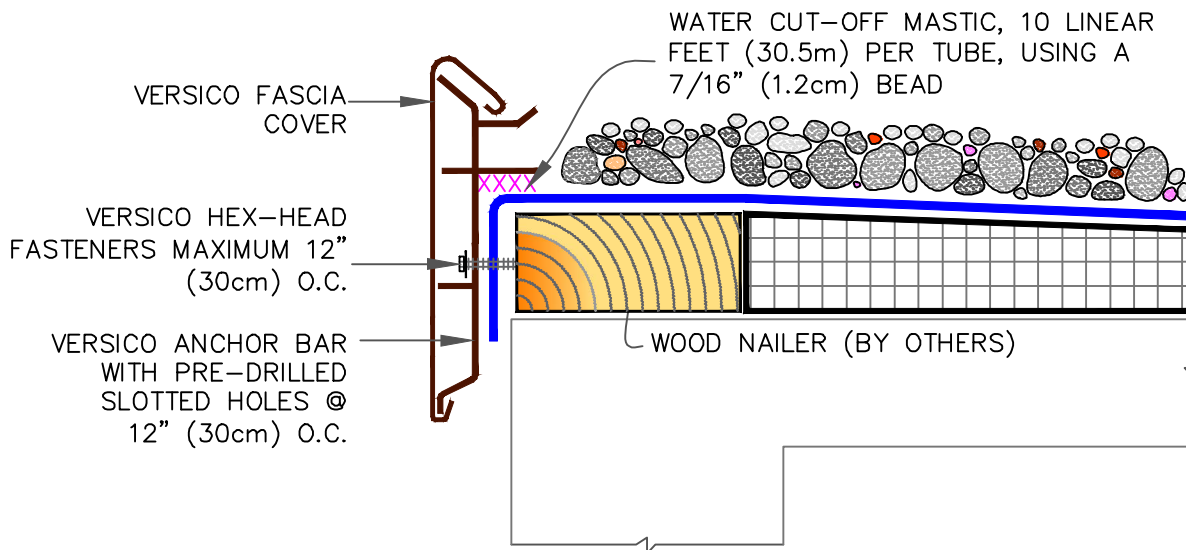

MAXIMUM WARRANTY: 30 YEARS



VERSITRIM EX SNAP-ON FASCIA & VERSITRIM SNAP-ON FASCIA

→ EPDM MEMBRANE

→ APPROVED SUBSTRATE

→ SEE NOTE(S)

VersiGard COMMON DETAILS (EPDM)

VGC-1.3

NOTES:

1. DECK FLANGE MUST BE TOTALLY COVERED WITH MINIMUM 2" (5cm) COVERAGE PAST NAIL HEADS. TO REMOVE FINISHING OILS, SCRUB METAL FLANGE WITH WEATHERED MEMBRANE CLEANER; ALLOW TO DRY PRIOR TO APPLYING PRIMER.
2. LAP SEALANT MUST BE APPLIED AT FLASHING OVERLAPS AND INTERSECTIONS WITH JOINTS IN METAL EDGING.
3. T-JOINT COVER NOT NEEDED WHEN USING PS OVERLAYMENT STRIP ON MEMBRANE LESS THAN 90-MIL.
4. WHEN USING 90-MIL MEMBRANE INSTALL A 12" (30cm) T-JOINT COVER OVER THE 6" (15cm) T-JOINT COVER PER [VGC-2.2A](#)
5. DETAIL NOT FOR USE WITH DESIGN "B" (BALLASTED STONE ASSEMBLY).

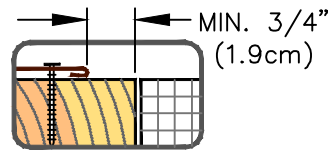
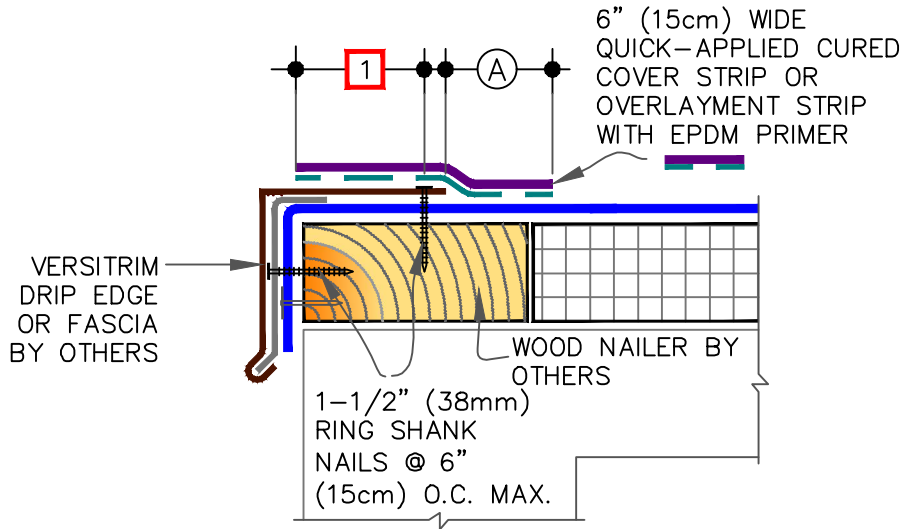

DIMENSIONS		cm	
(A)	2"	5	MIN.
(B)	1/2"	1.5	TO
	1"	2.5	

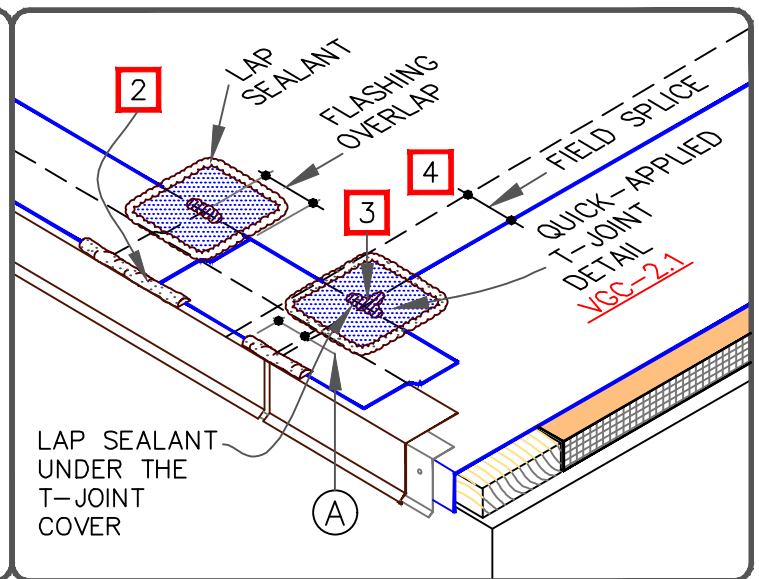
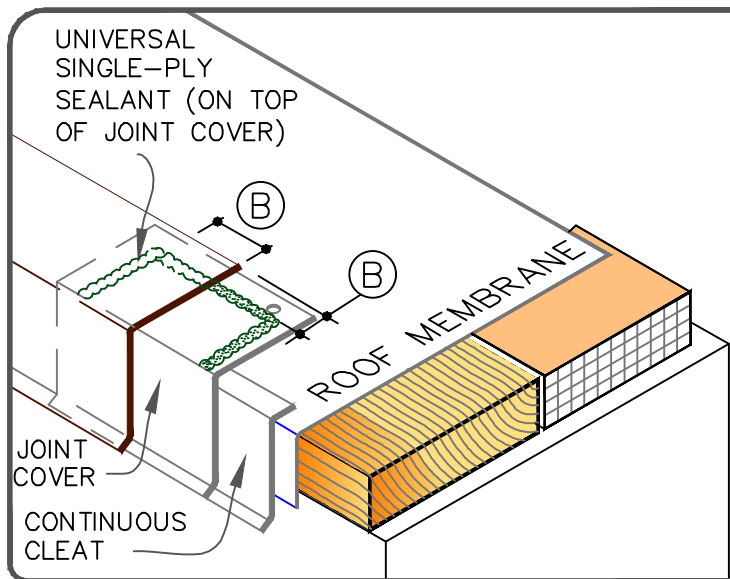

MAXIMUM WARRANTY: 25 YEARS



VERSITRIM DRIP EDGE

→ EPDM MEMBRANE
 → APPROVED SUBSTRATE
 → SEE NOTE(S)

VersiGard COMMON DETAILS (EPDM)

VGC-1.4

OPTION 1

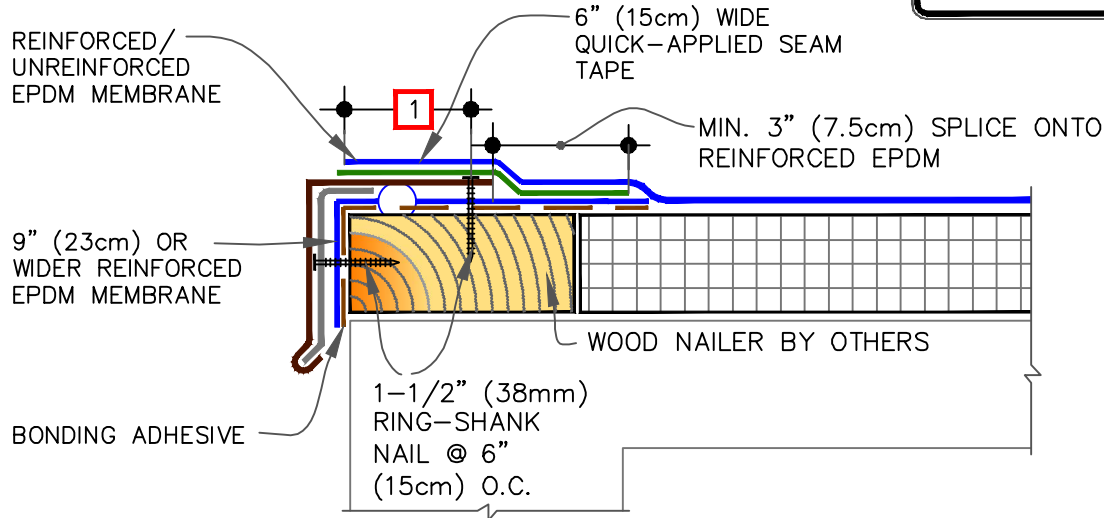

OPTION 2

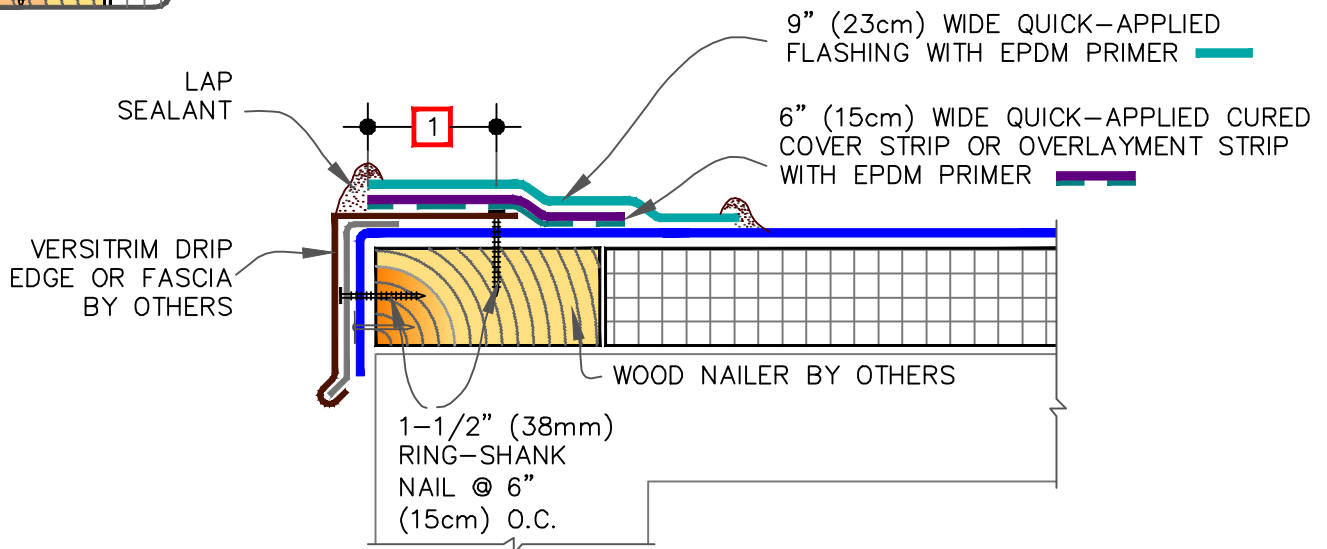
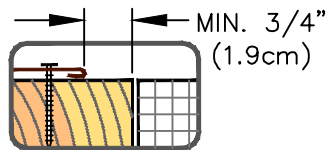



NOTES:

1. DECK FLANGE MUST BE TOTALLY COVERED WITH MINIMUM 2" (5cm) COVERAGE PAST NAIL HEADS. TO REMOVE FINISHING OILS, SCRUB METAL FLANGE WITH WEATHERED MEMBRANE CLEANER; ALLOW TO DRY PRIOR TO APPLYING PRIMER.
2. LAP SEALANT MUST BE APPLIED AT FLASHING OVERLAPS AND INTERSECTIONS WITH JOINTS IN METAL EDGING.
3. ALL SPLICE INTERSECTIONS MUST BE OVERLAID WITH QUICK-APPLIED T-JOINT COVERS AND SEALED WITH CONTINUOUS LAP SEALANT. PRIOR TO DOING SO, APPLY LAP SEALANT ALONG THE LEADING EDGE OF THE MEMBRANE SPLICES (UNDER THE 6" X 6" (15cm X 15cm) T-JOINT COVER) COVERING THE EXPOSED SPLICE TAPE 1/2" (1.5cm) IN ALL DIRECTIONS FROM THE SPLICE INTERSECTION.
4. DETAIL NOT FOR USE WITH DESIGN "B" (BALLASTED STONE ASSEMBLY).

MAXIMUM WARRANTY: 30 YEARS



VERSITRIM DRIP EDGE (30
YEAR WARRANTIES)

-  → EPDM MEMBRANE
-  → APPROVED
SUBSTRATE
-  → SEE NOTE(S)

VersiGard COMMON
DETAILS (EPDM)

VGC-1.4A

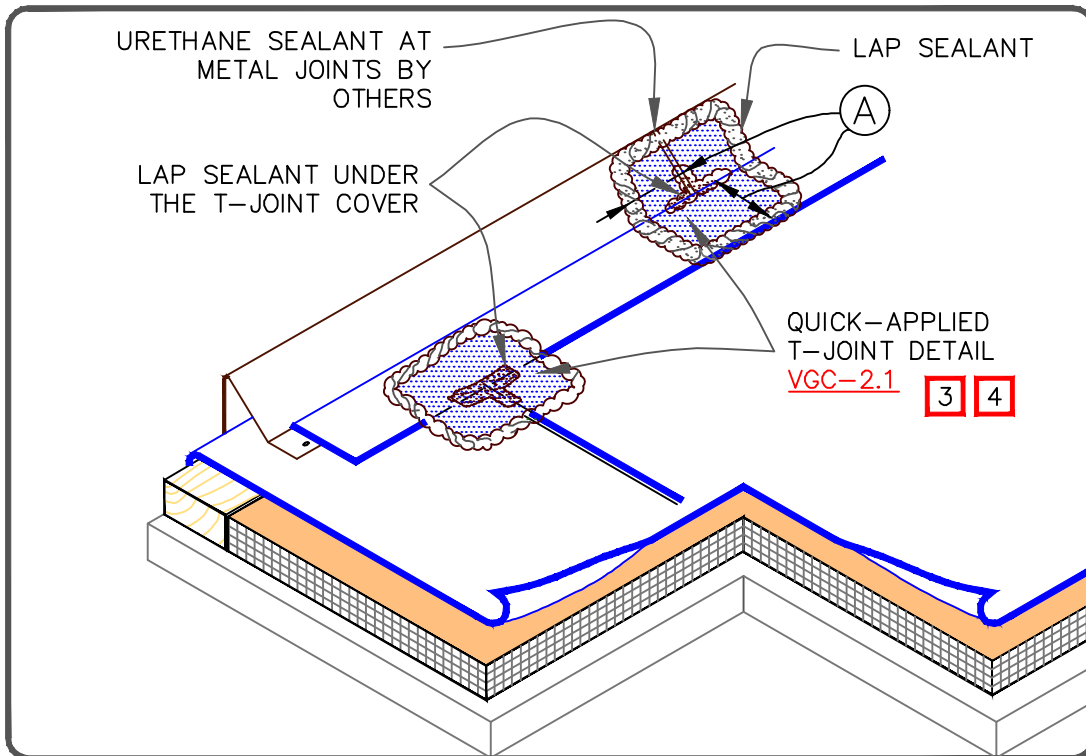
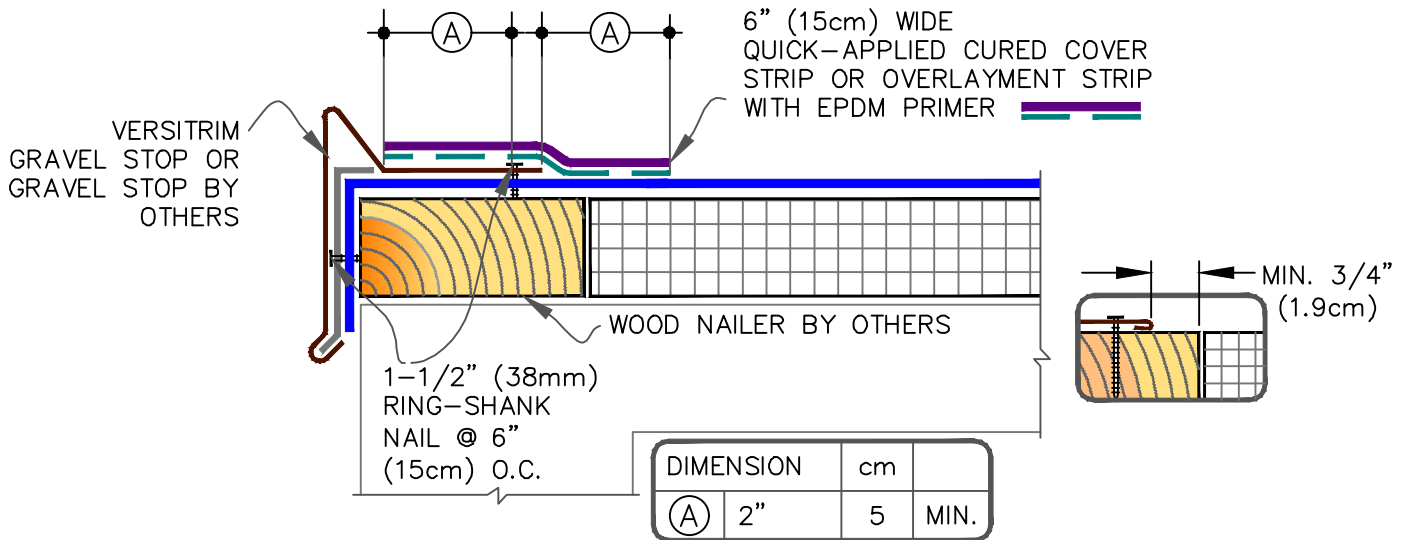

NOTES:

1. TO REMOVE FINISHING OILS, SCRUB METAL FLANGE WITH WEATHERED MEMBRANE CLEANER; ALLOW TO DRY PRIOR TO APPLYING PRIMER.
2. LAP SEALANT MUST BE APPLIED AT FLASHING OVERLAPS AND INTERSECTIONS WITH JOINTS IN METAL EDGING.
3. T-JOINT COVER AT SPLICE INTERSECTION NOT NEEDED WHEN USING PS OVERLAYMENT STRIP ON MEMBRANE LESS THAN 90-MIL.
4. WHEN USING 90-MIL MEMBRANE INSTALL A 12" (30cm) T-JOINT COVER OVER THE 6" (15cm) T-JOINT COVER PER [VGC-2.2A](#)

MAXIMUM WARRANTY: 25 YEARS



VERSITRIM GRAVEL STOP

	→ EPDM MEMBRANE
	→ APPROVED SUBSTRATE
0	→ SEE NOTE(S)

VersiGard COMMON DETAILS (EPDM)

VGC-1.5

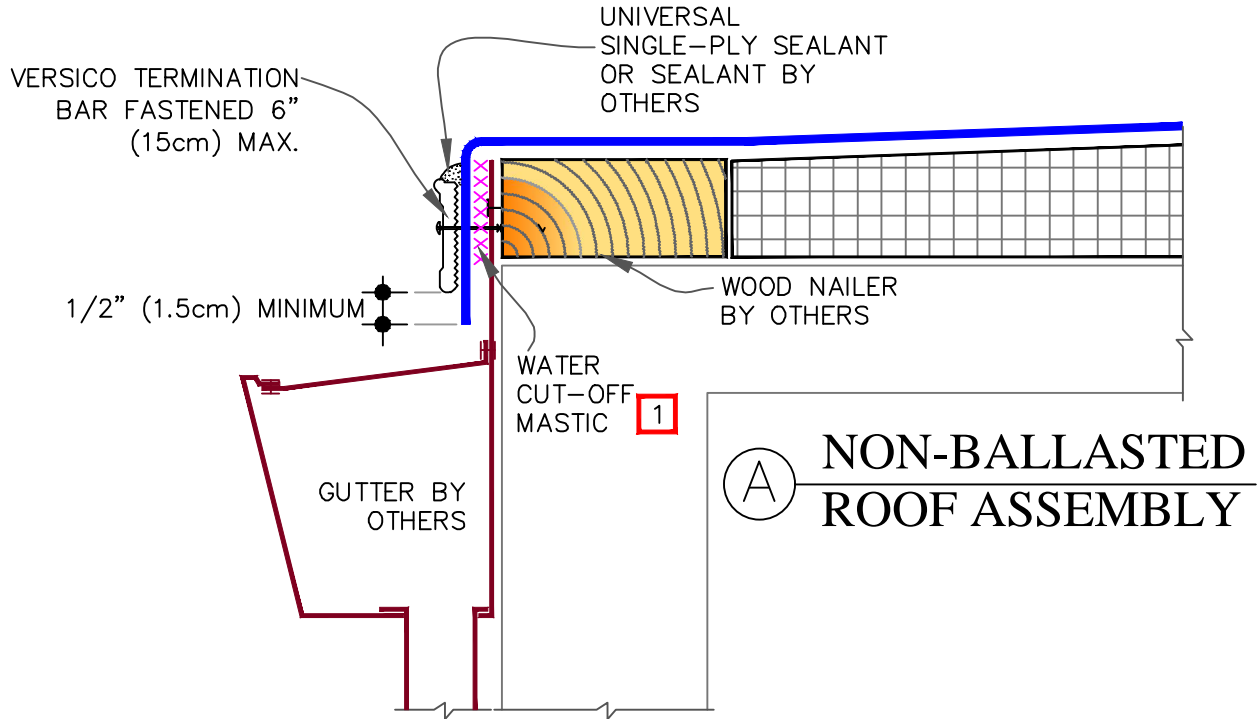

NOTES:

1. FASTENING OF METAL TERMINATION OR BALLAST RETAINING BAR MUST PROVIDE CONSTANT COMPRESSION ON WATER CUT-OFF MASTIC.
2. BALLAST RETAINING BAR MUST EXTEND ABOVE GRAVEL SURFACE SUFFICIENTLY TO RETAIN GRAVEL AND PREVENT GRAVEL MIGRATION.
3. SLOTS IN BALLAST RETAINING BAR MUST BE FLUSH OR SLIGHTLY BELOW MEMBRANE LEVEL.

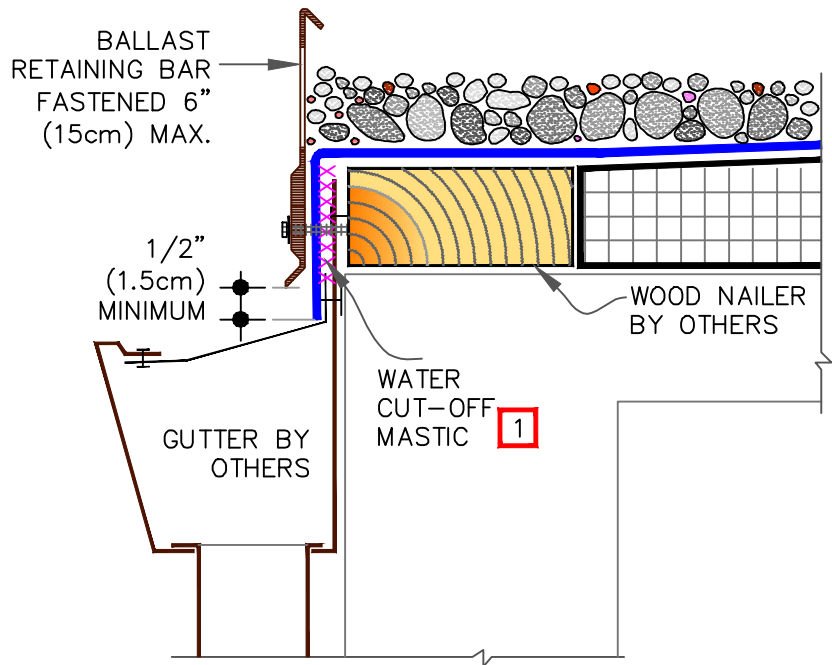

(B) BALLASTED ROOF ASSEMBLY

MAXIMUM WARRANTY: 30 YEARS



METAL BAR EDGE TERMINATION

█ → EPDM MEMBRANE
0 → APPROVED SUBSTRATE
1 → SEE NOTE(S)

VersiGard COMMON DETAILS (EPDM)

VGC-1.6

SEAM WITH FIELD APPLIED TAPE

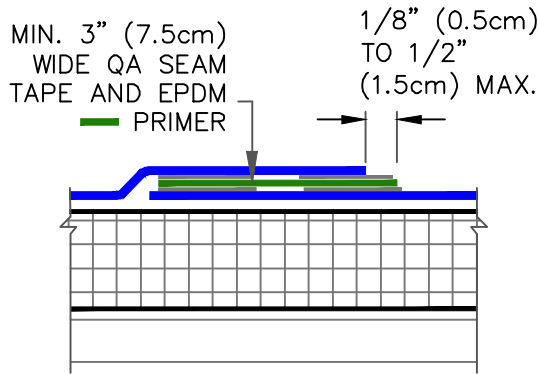

SEAM WITH FACTORY APPLIED TAPE

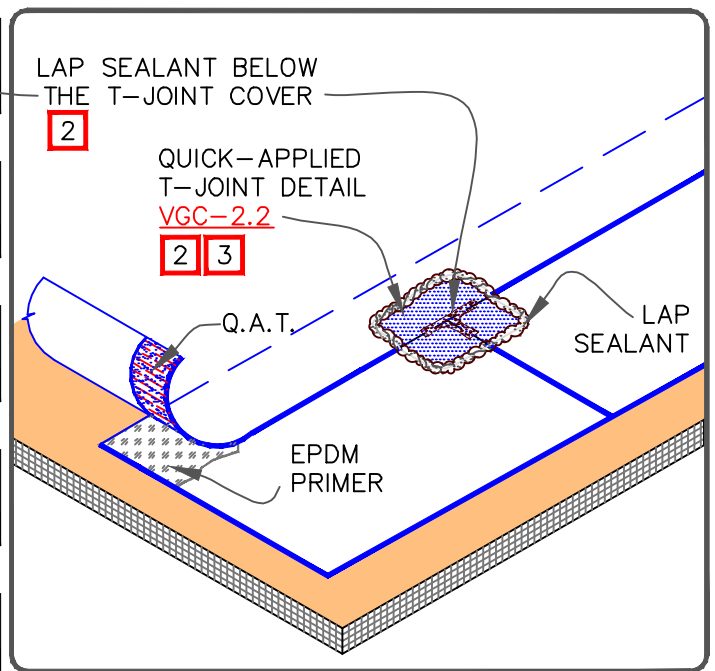
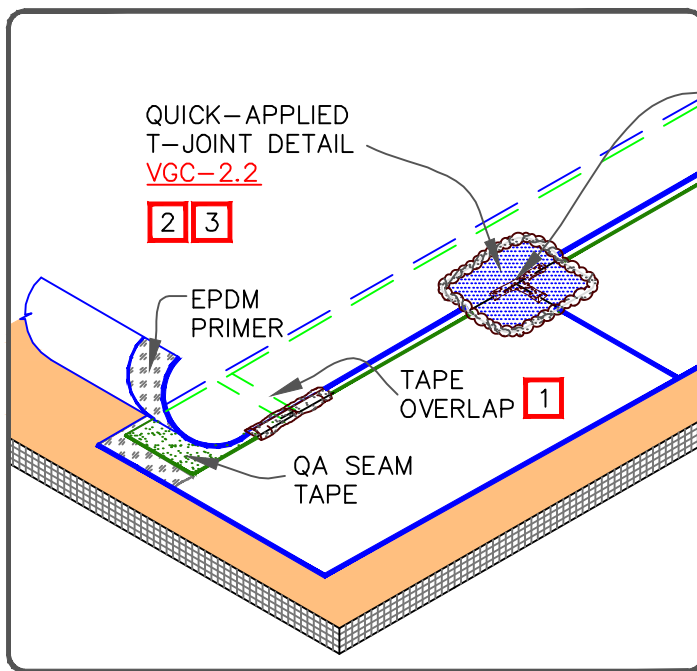
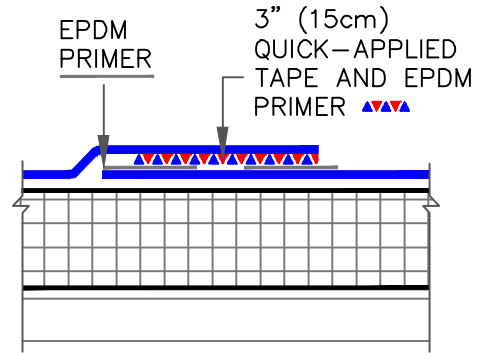

NOTES:

1. OVERLAP THE ENDS OF THE FIELD APPLIED QA SEAM TAPE A MINIMUM OF 1" (2.5cm). APPLY LAP SEALANT AT TAPE OVERLAPS 2" (5cm) IN EACH DIRECTION AS SHOWN.
2. APPLY LAP SEALANT ALONG THE EXPOSED EDGE OF THE MEMBRANE SPLICE COVERING THE EXPOSED SPLICE TAPE 1/2" (1.5cm) IN EACH DIRECTION FROM THE SPLICE INTERSECTION AND OVERLAY WITH A 6" (15cm) T-JOINT COVER.
3. WHEN USING 90-MIL MEMBRANE, INSTALL A 12" (30cm) T-JOINT COVER CENTERED OVER THE FIRST T-JOINT COVER PER DETAIL [VGC-2.2A](#).
4. LAP SEALANT IS REQUIRED ON CUT EDGES OF REINFORCED EPDM MEMBRANE.
5. REFER TO DETAIL [VGMA-2.1](#) FOR MECHANICALLY ATTACHED SPLICES.

MAXIMUM WARRANTY: 25 YEARS



EPDM MEMBRANE SPLICE

	→ EPDM MEMBRANE
	→ APPROVED SUBSTRATE
	→ SEE NOTE(S)

VersiGard COMMON DETAILS (EPDM)

VGC-2.1

OPTION 1: NARROW SEAM WITH OVERLAYMENT

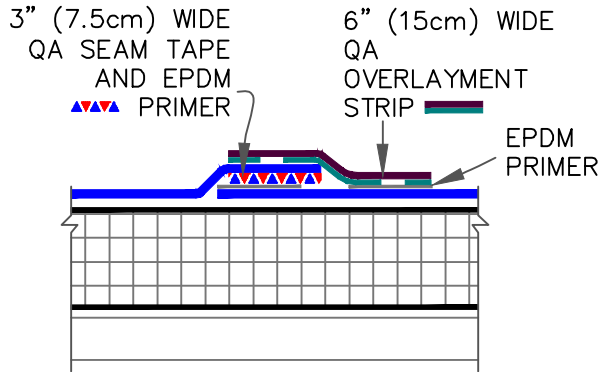

OPTION 2: WIDER SEAM

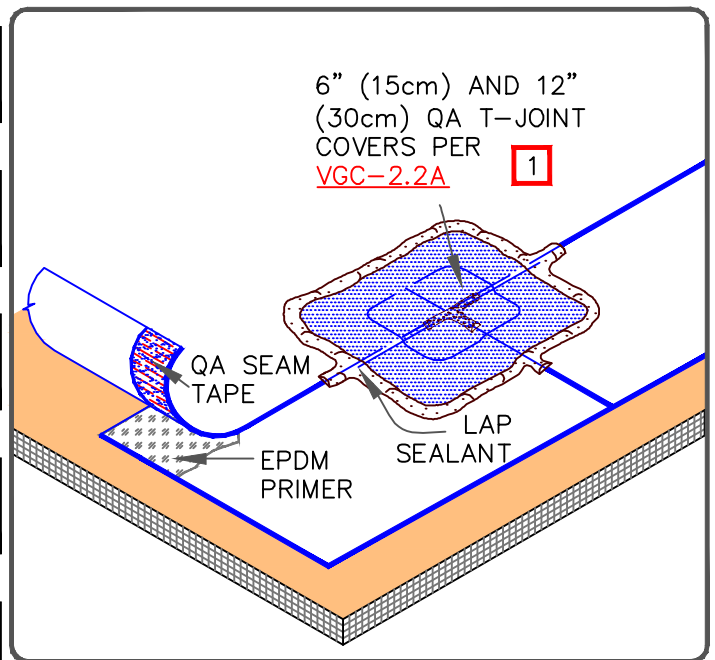
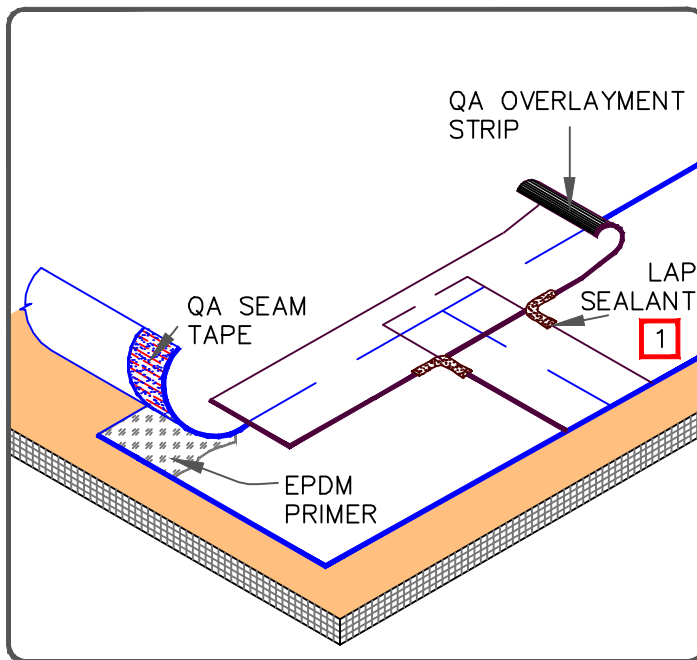
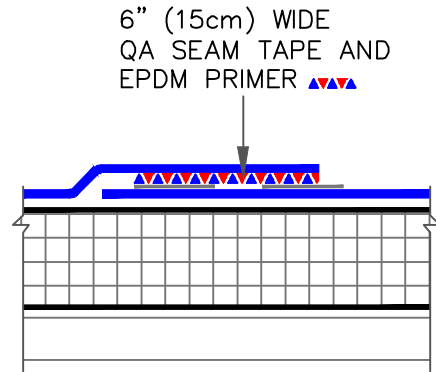

QA (QUICK-APPLIED)

NOTES:

1. APPLY LAP SEALANT AT ALL INTERSECTIONS BETWEEN QUICK-APPLIED OVERLAYMENT STRIP.
2. REFER TO DETAIL [VGMA-2.1A](#) FOR MECHANICALLY-ATTACHED SPLICES.



NOTE:

1. APPLY LAP SEALANT ALONG THE EXPOSED EDGE OF THE MEMBRANE SPLICE COVERING THE EXPOSED SPLICE TAPE 1/2" (1.5cm) IN EACH DIRECTION FROM THE SPLICE INTERSECTION AND OVERLAY WITH A 6" (15cm) T-JOINT COVER. INSTALL A 12" (30cm) T-JOINT COVER CENTERED OVER THE FIRST T-JOINT COVER PER DETAIL [VGC-2.2A](#).

MAXIMUM WARRANTY: 30 YEARS



EPDM MEMBRANE SPLICE
(30 YEAR WARRANTIES)

-  → EPDM MEMBRANE
-  → APPROVED SUBSTRATE
-  → SEE NOTE(S)

VersiGard COMMON
DETAILS (EPDM)

VGC-2.1A

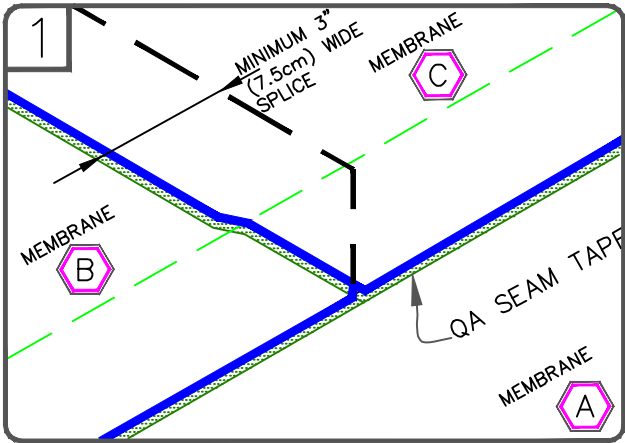

POSITION MEMBRANE TO ALLOW AN APPROXIMATE 4" (10cm) OVERLAP. MARK THE BOTTOM SHEET WITH AN INDELIBLE MARKER 1/2" (1.5cm) FROM THE EDGE OF THE TOP SHEET AS SHOWN. THE PRE-MARKED LINE ON THE MEMBRANE EDGE CAN ALSO BE USED AS A GUIDE.

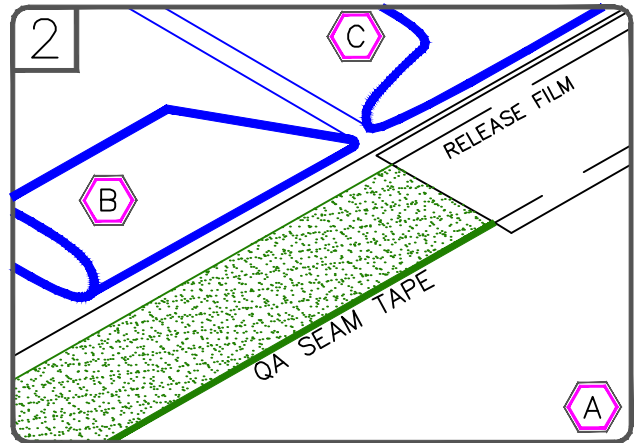

FOLD SHEETS BACK AS SHOWN. APPLY EPDM PRIMER TO THE SPLICE AREA ON BOTH SURFACES AND ALLOW TO FLASH-OFF. APPLY QA SEAM TAPE WITH RELEASE FILM ALIGNED WITH MARKED LINE.

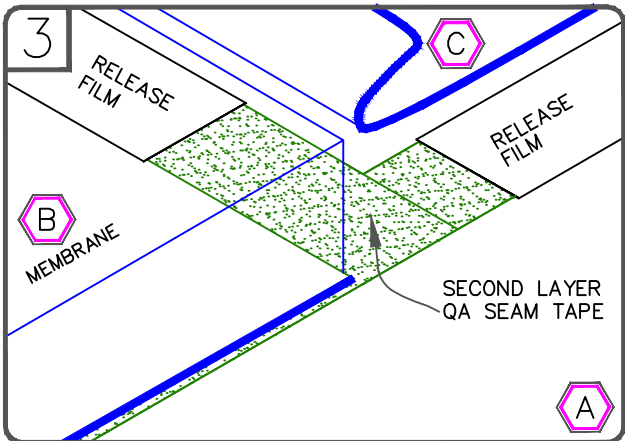

SPLICE SHEET B TO SHEET A AND APPLY SECOND PIECE OF QA SEAM TAPE BETWEEN SHEET B AND C. TRIM RELEASE FILM AS SHOWN.

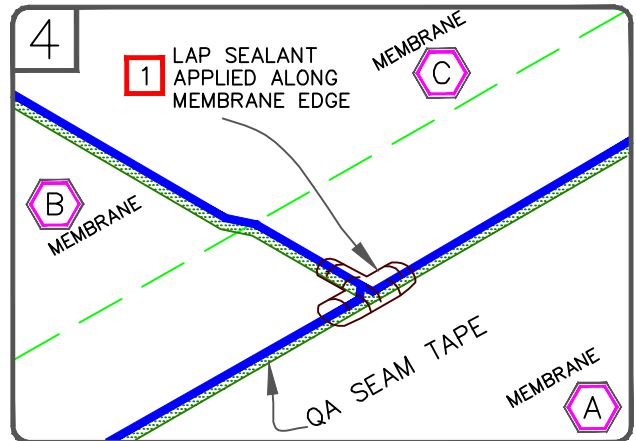

SPLICE SHEET C TO SHEET A AND B, PRESS TOP SHEET ONTO BOTTOM SHEET USING HAND PRESSURE TOWARDS THE OUTER EDGE OF THE SPLICE AND ROLL THE SPLICE AREA WITH A 2" (5cm) WIDE STEEL ROLLER.

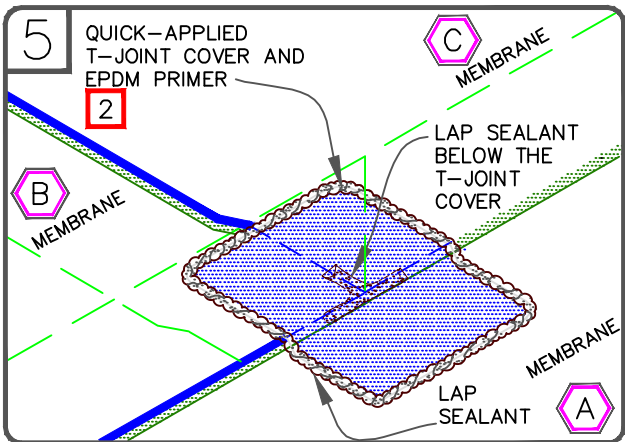

APPLY QUICK-APPLIED T-JOINT COVER OR 6" (15cm) WIDE SECTION OF QUICK-APPLIED UNCURED FLASHING CENTERED OVER THE INTERSECTING POINT OF THE LEADING EDGES OF THE FIELD SPLICE INTERSECTION AS SHOWN.



MAXIMUM WARRANTY: 25 YEARS

NOTES:

1. APPLY LAP SEALANT ALONG THE EDGE OF THE MEMBRANE SPLICE BELOW THE 6" (15cm) T-JOINT COVER, COVERING THE EXPOSED SPLICE TAPE 1/2" (1.5cm) IN EACH DIRECTION FROM THE SPLICE INTERSECTION.
2. APPLY LAP SEALANT AT CUT EDGES OF REINFORCED MEMBRANE AND TAPE OVERLAPS. REFER TO [DETAIL VGC-2.1](#).
3. REFER TO [DETAIL VGC-2.2A](#) WHEN USING 90-MIL MEMBRANE.



EPDM MEMBRANE SPLICE INTERSECTION

-  → EPDM MEMBRANE
-  → APPROVED SUBSTRATE
-  → SEE NOTE(S)

VersiGard COMMON DETAILS (EPDM)

VGC-2.2

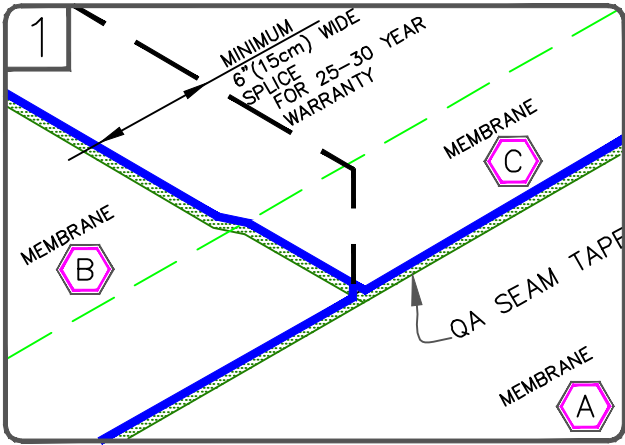

POSITION MEMBRANE TO ALLOW AN APPROXIMATE 7" (17.5cm) OVERLAP. MARK THE BOTTOM SHEET WITH AN INDELIBLE MARKER 1/2" (1.5cm) FROM THE EDGE OF THE TOP SHEET AS SHOWN. THE PRE-MARKED LINE ON THE MEMBRANE EDGE CAN ALSO BE USED AS A GUIDE.

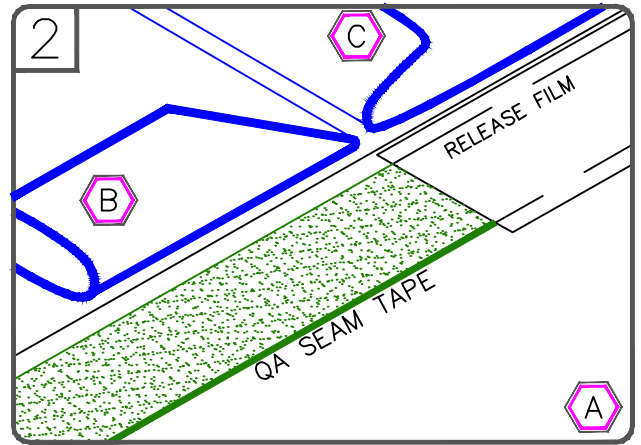

FOLD SHEETS BACK AS SHOWN. APPLY EPDM PRIMER TO THE SPLICE AREA ON BOTH SURFACES AND ALLOW TO FLASH-OFF. APPLY QA SEAM TAPE WITH RELEASE FILM ALIGNED WITH MARKED LINE.

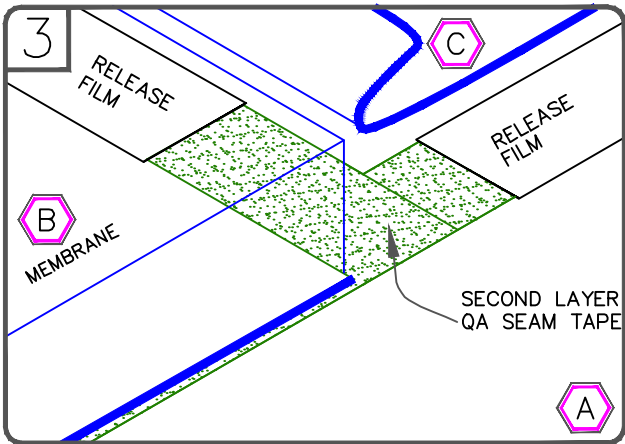

SPLICE SHEET B TO SHEET A AND APPLY SECOND PIECE OF QA SEAM TAPE BETWEEN SHEET B AND C. TRIM RELEASE FILM AS SHOWN.

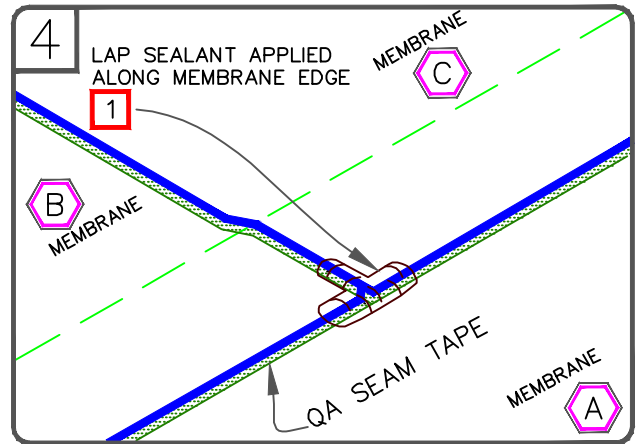

SPLICE SHEET C TO SHEET A AND B, PRESS TOP SHEET ONTO BOTTOM SHEET USING HAND PRESSURE TOWARDS THE OUTER EDGE OF THE SPLICE AND ROLL THE SPLICE AREA WITH A 2" (5cm) WIDE STEEL ROLLER.

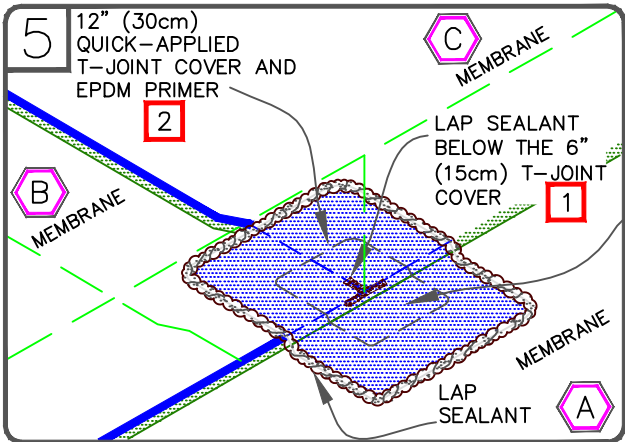

APPLY 6" (15cm) QUICK-APPLIED T-JOINT COVER AND 12" (30cm) QUICK-APPLIED T-JOINT COVER OR QUICK-APPLIED UNCURED CENTERED OVER THE INTERSECTING POINT OF THE LEADING EDGES OF THE FIELD SPLICE INTERSECTION AS SHOWN.



MAXIMUM WARRANTY: 30 YEARS

NOTES:

1. APPLY LAP SEALANT ALONG THE EDGES OF THE MEMBRANE SPLICE COVERING THE EXPOSED SPLICE TAPE 1/2" (15cm) IN EACH DIRECTION FROM THE SPLICE INTERSECTION.
2. APPLY LAP SEALANT AT CUT EDGES OF REINFORCED MEMBRANE AND TAPE OVER LAPS.



EPDM MEMBRANE SPLICE INTERSECTION (30 YEAR WARRANTIES OR 90 MIL MEMBRANE)

-  → EPDM MEMBRANE
-  → APPROVED SUBSTRATE
-  → SEE NOTE(S)

VersiGard COMMON DETAILS (EPDM)

VGC-2.2A

CONTINUOUS WALL FLASHING

SEPARATE WALL FLASHING

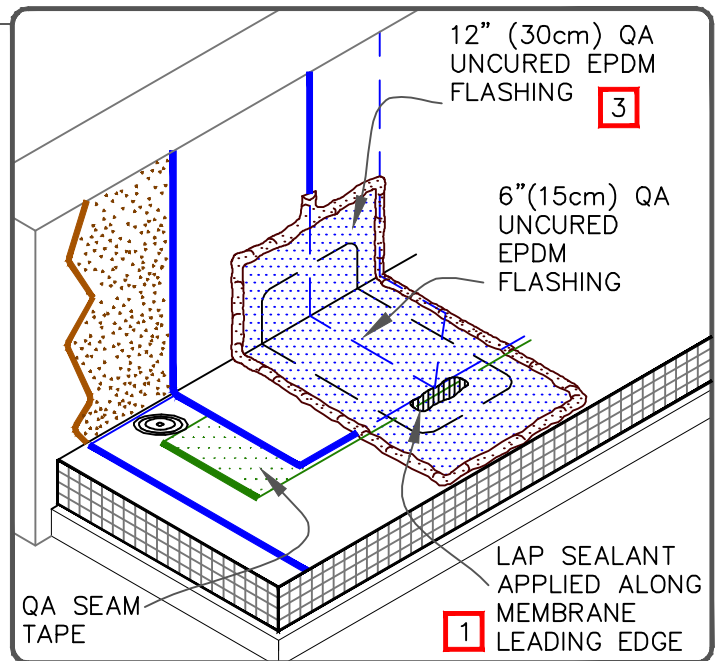
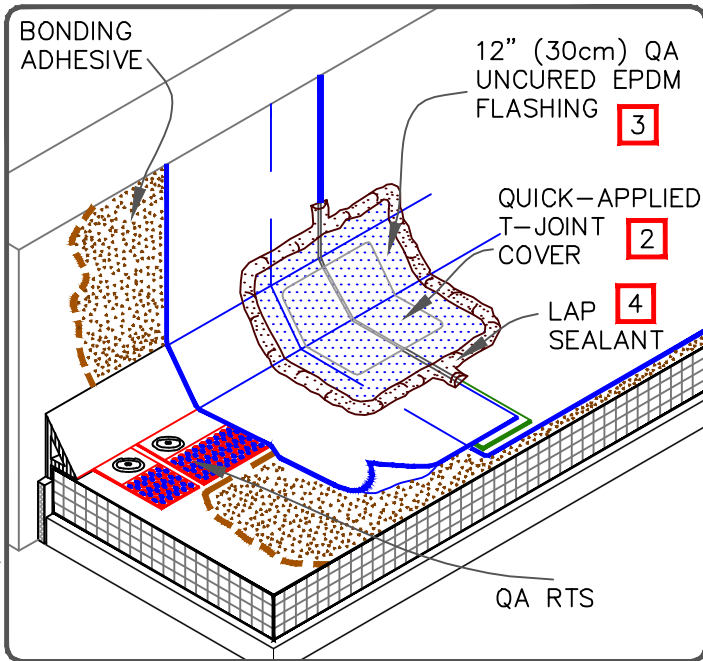

QA (QUICK-APPLIED)

CONTINUOUS WALL FLASHING

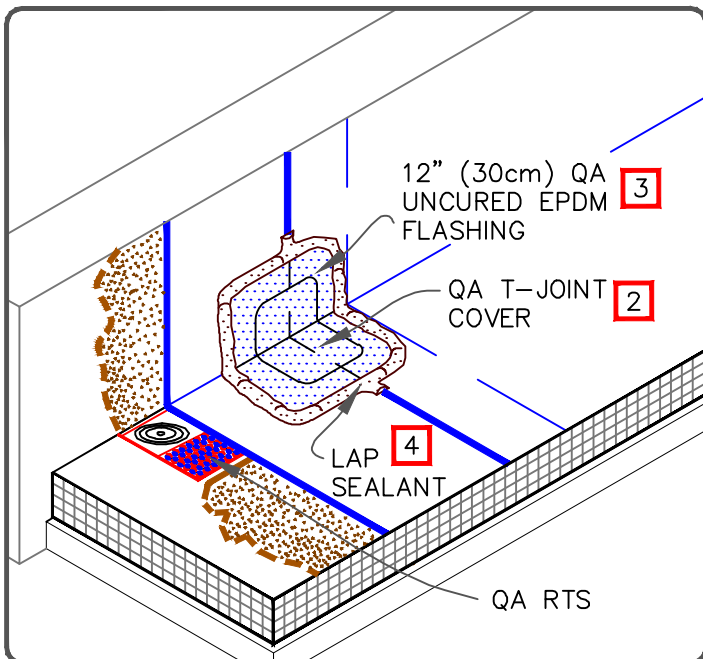



NOTES:

1. APPLY LAP SEALANT ALONG THE LEADING EDGE OF THE MEMBRANE SPLICE (UNDER THE QUICK-APPLIED UNCURED FLASHING) COVERING THE EXPOSED SPLICE TAPE APPROXIMATELY 1/2" (1.5cm) BEYOND THE SPLICE EDGE.
2. QUICK-APPLIED T-JOINT COVER OR 6" (15cm) WIDE QUICK-APPLIED FLASHING, WITH EPDM PRIMER, MUST BE CENTERED OVER FIELD SPLICES AT THE ANGLE CHANGE.
3. PROJECTS WITH 30-YEAR WARRANTY OR WHEN USING 90-MIL MEMBRANE REQUIRE FIELD SPLICES TO BE OVERLAID WITH TWO LAYERS OF QUICK-APPLIED UNCURED EPDM FLASHING. THE BOTTOM LAYER SHALL BE 6" (15cm) WIDE COVERED WITH A 12" (30cm) WIDE TOP LAYER. BOTH LAYERS SHALL BE CENTERED.
4. SEAL EXPOSED LAYER WITH LAP SEALANT.

MAXIMUM WARRANTY: 30 YEARS



EPDM MEMBRANE SPLICES AT ANGLE CHANGE

-  → EPDM MEMBRANE
-  → APPROVED SUBSTRATE
-  → SEE NOTE(S)

VersiGard COMMON DETAILS (EPDM)

VGC-2.3

SIDE LAP SPLICE

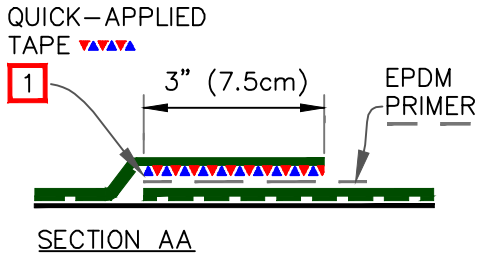

END LAP SPLICE

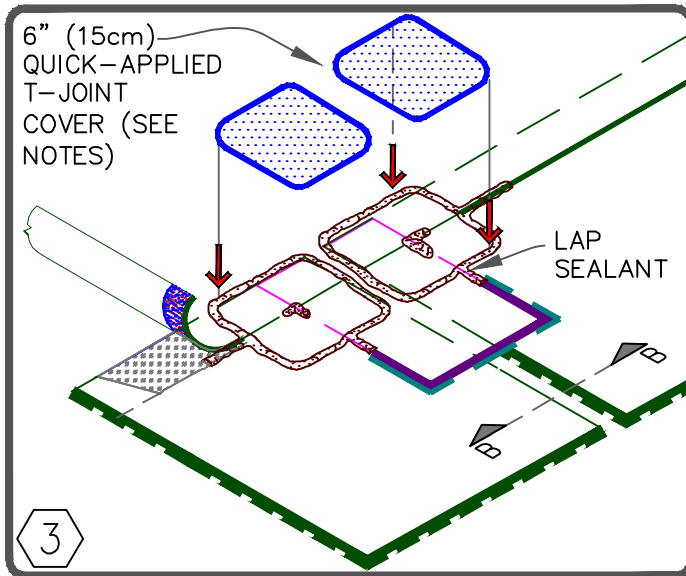
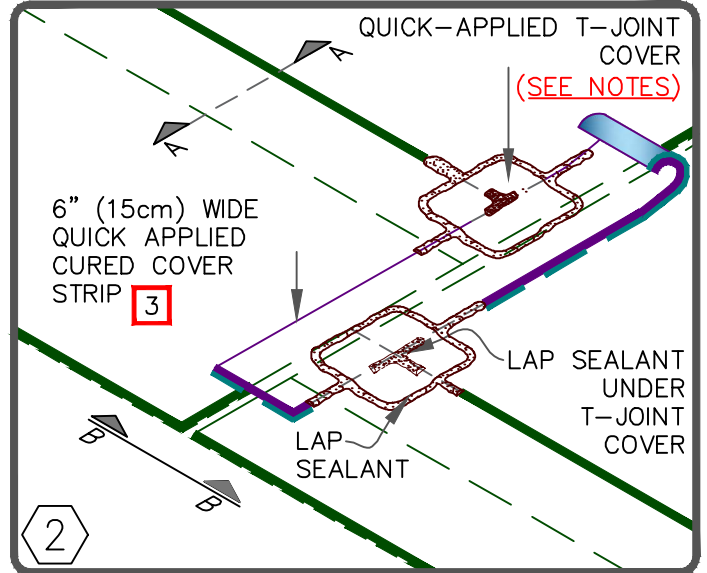
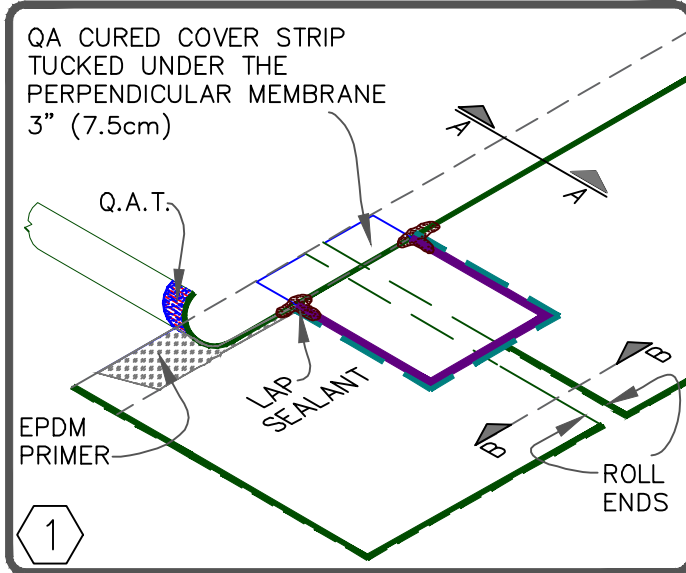
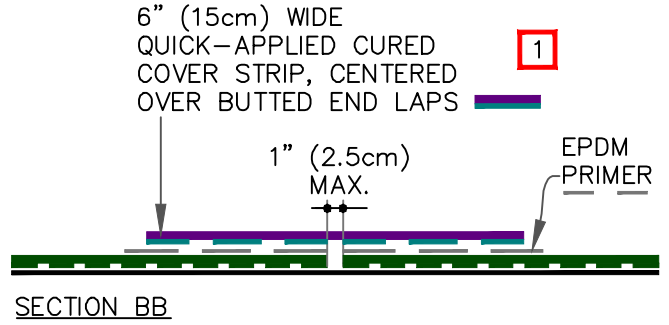

NOTES:

1. APPLY LAP SEALANT ALONG THE EDGE OF THE MEMBRANE SPLICE (UNDER THE 6"x6" T-JOINT COVER) COVERING THE EXPOSED SPLICE TAPE 1/2" (1.5cm) IN EACH DIRECTION FROM THE SPLICE INTERSECTION.
2. APPLY A 6" (15cm) T-JOINT COVER OR QUICK-APPLIED UNCURED EPDM FLASHING AND LAP SEAL THE EDGES.
3. QUICK-APPLIED OVERLAYMENT STRIP CAN BE USED WHEN QA IS OVERLAPPED A MINIMUM 1" (2.5cm) AND ELIMINATES THE NEED FOR T-JOINT COVERS.

MAXIMUM WARRANTY: 20 YEARS



QA EPDM MEMBRANE SPLICES – PROJECTS WITH 10, 15 AND 20 YEAR WARRANTIES

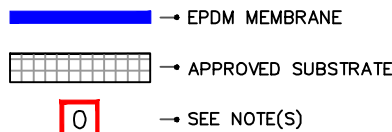

QUICK APPLIED TECHNOLOGY

VGC-2.4

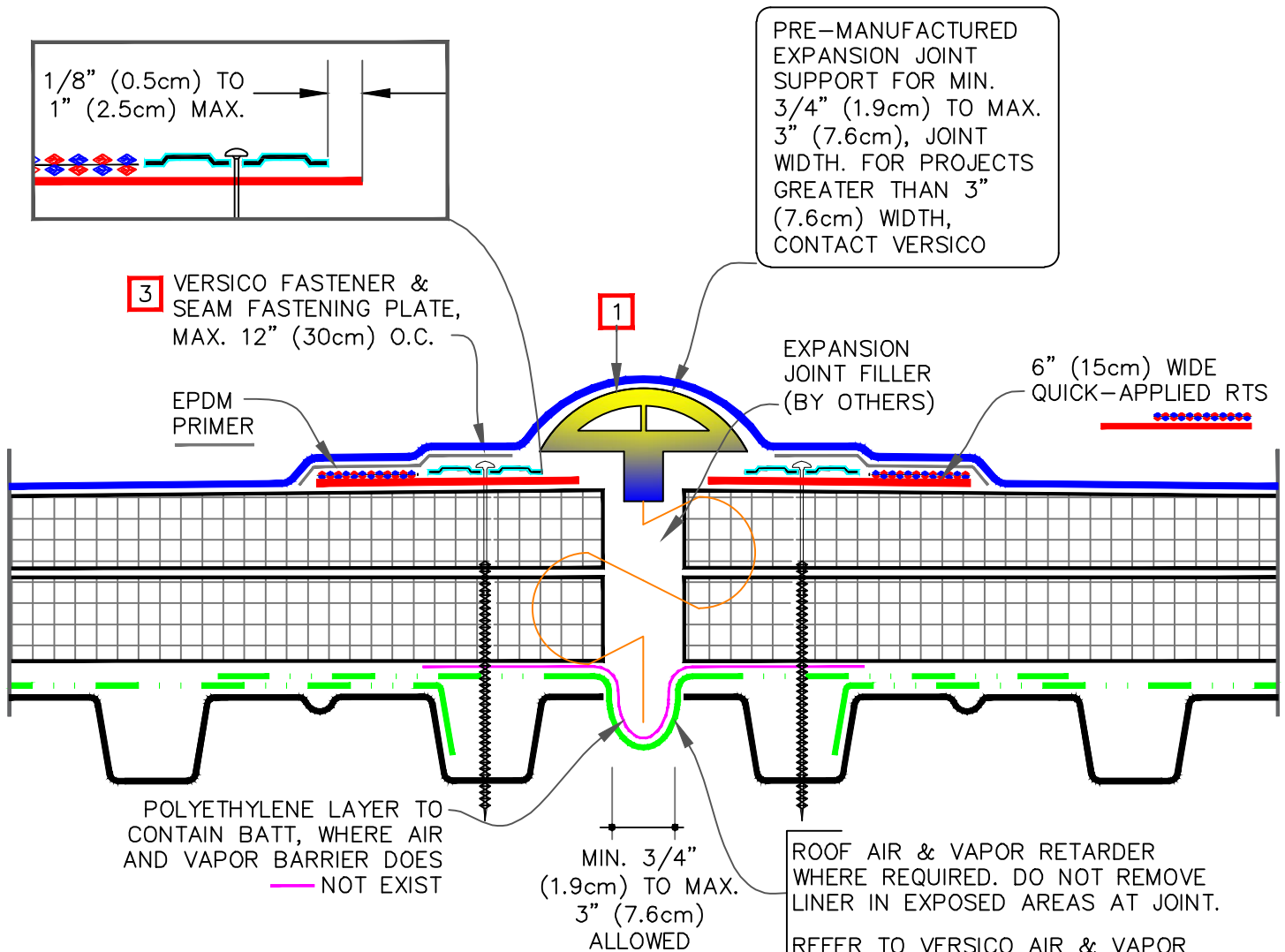

NOTES:

- MEMBRANE SHALL NOT BE ADHERED OVER THE EXPANSION JOINT SUPPORT.
- FOR EXPANSION JOINT INTERSECTIONS AND INTERSECTIONS BETWEEN EXPANSION JOINTS TO WALL OR EDGING, USE TWO LAYERS OF QUICK-APPLIED UNCURED EPDM FLASHING WITH SECOND LAYER 3" (7.5cm) LARGER THAN PREVIOUS LAYER IN ALL DIRECTIONS.
- HPV FASTENERS AND POLYMER SEAM PLATES ARE REQUIRED ON MECHANICALLY ATTACHED SYSTEMS OVER STEEL DECKS.

MAXIMUM WARRANTY: 30 YEARS



DECK-TO-DECK EXPANSION JOINT

- EPDM MEMBRANE
- APPROVED SUBSTRATE
- SEE NOTE(S)

VersiGard COMMON DETAILS (EPDM)

VGC-3.1

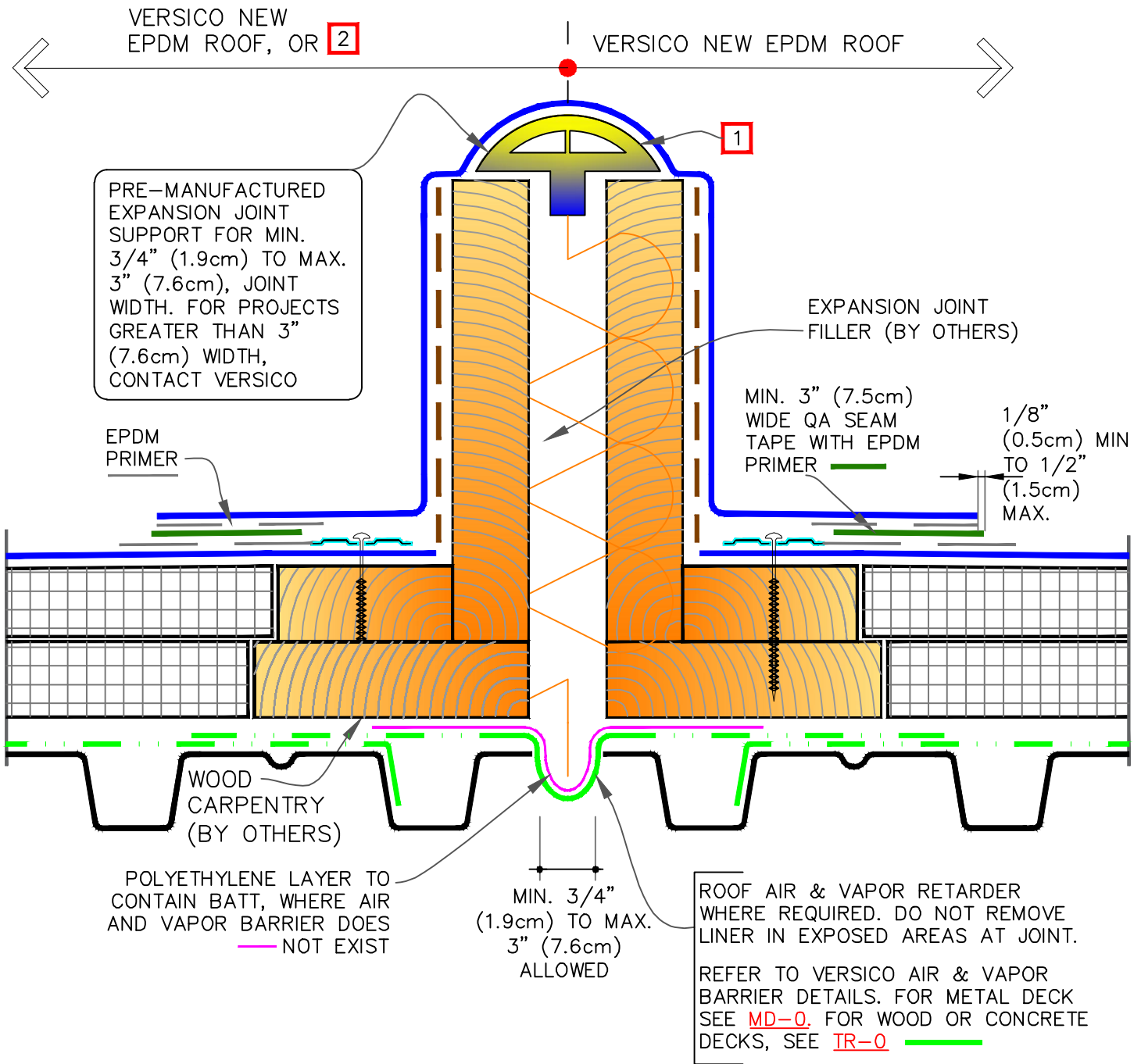

NOTES:

- MEMBRANE FLASHING SHALL NOT BE ADHERED OVER THE EXPANSION JOINT SUPPORT.
- IN CASE THE ROOF TYPE IS DIFFERENT, DESIGNER TO PROVIDE ROOF TYPE AND ITS CONDITION TO VERSICO TO DEVELOP A TIE-IN DETAIL ON THIS SIDE ACCORDINGLY.

MAXIMUM WARRANTY: 30 YEARS



DECK-TO-DECK CURBED EXPANSION DETAIL

- → EPDM MEMBRANE
- APPROVED SUBSTRATE
- 0 → SEE NOTE(S)

VersiGard COMMON DETAILS (EPDM)

VGC-3.1A

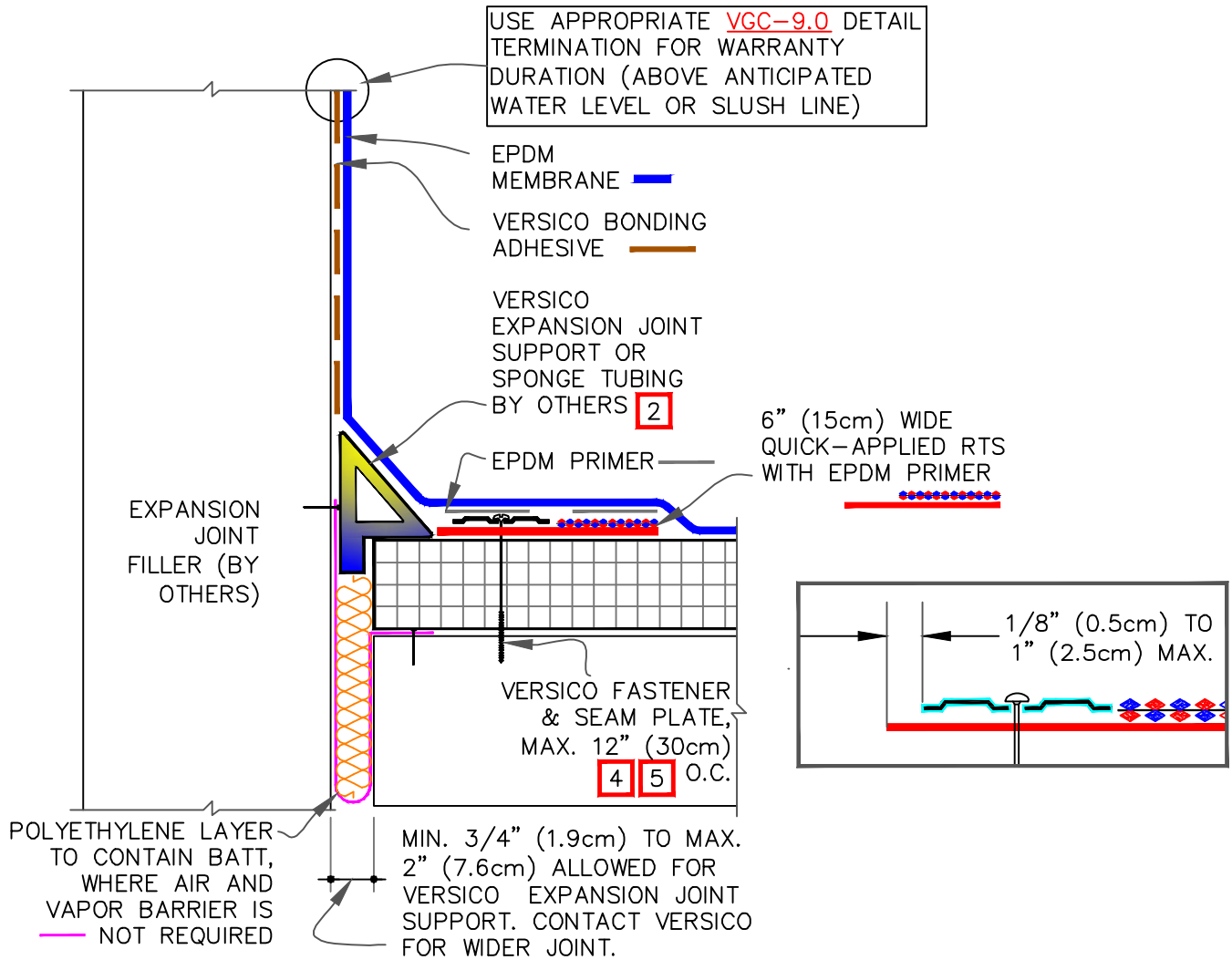

NOTES:

1. ALL OUTSIDE AND INSIDE CORNERS REQUIRE TWO COMPLETE CORNER APPLICATIONS OF QUICK-APPLIED UNCURED FLASHING AS PER [DETAILS VGC-15.4A OR VGC-15.7A](#).
2. ROOF MEMBRANE SHALL BE LOOSE-LAID OVER THE EXPANSION JOINT SUPPORT OR SPONGE TUBING.
3. USE [DETAIL VGC-2.3](#) FOR EPDM MEMBRANE SPLICES AT ANGLE CHANGES.
4. HPV FASTENERS AND POLYMER SEAM PLATES ARE REQUIRED ON MECHANICALLY ATTACHED SYSTEMS OVER STEEL DECKS.
5. MAXIMUM 6" (15cm) FASTENER SPACING FOR WARRANTY WIND SPEEDS GREATER THAN 90 MPH OR WARRANTIES EXCEEDING 20 YEARS.

MAXIMUM WARRANTY: 30 YEARS



DECK-TO-WALL EXPANSION JOINT

█ → EPDM MEMBRANE
 → APPROVED SUBSTRATE
 → SEE NOTE(S)

VersiGard COMMON DETAILS (EPDM)

VGC-3.2

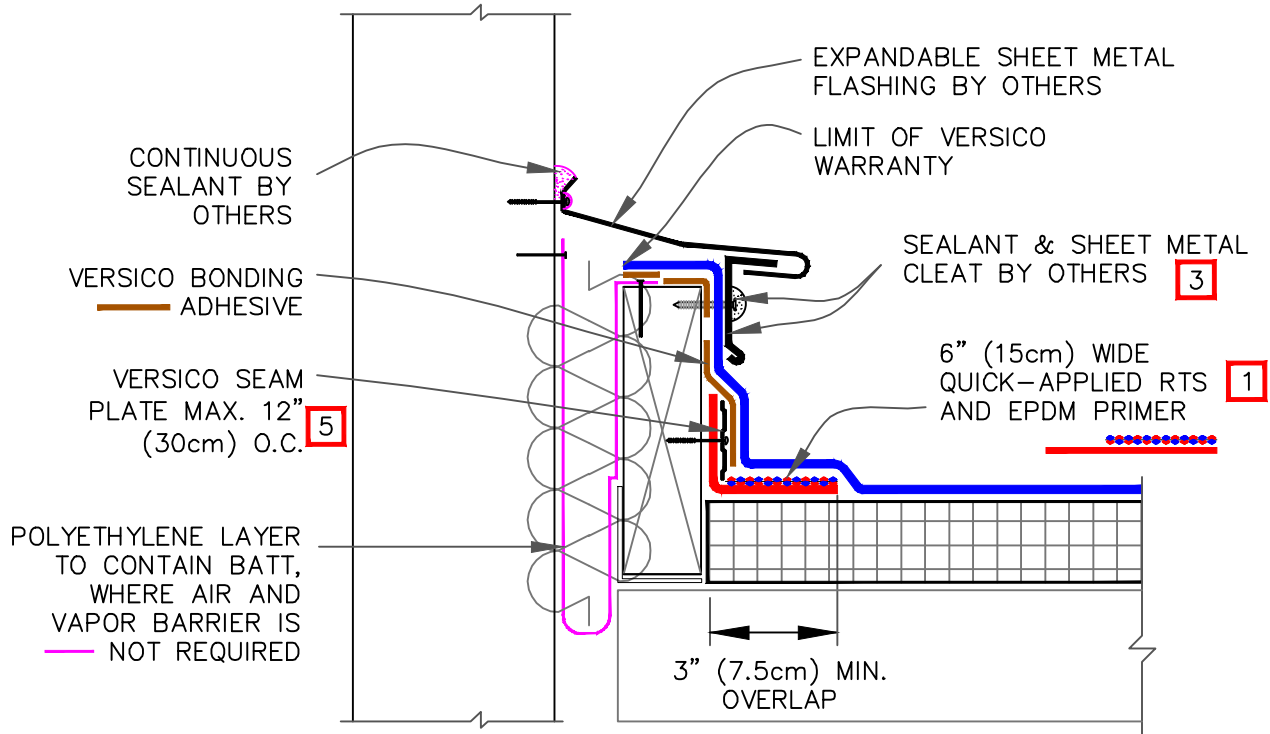

NOTES:

1. QUICK APPLIED RTS MAY BE INSTALLED INTO THE STRUCTURAL DECK. HPV FASTENERS AND POLYMER SEAM PLATES ARE REQUIRED ON MECHANICALLY-ATTACHED ROOFING SYSTEMS OVER STEEL DECKS.
2. USE [DETAIL VGC-2.3](#) FOR EPDM MEMBRANE SPLICES AT ANGLE CHANGES.
3. SEAL FASTENERS BY APPLYING WATER CUT-OFF MASTIC UNDER THE COUNTER-FLASHING, OR USING EPDM WASHERS, OR CAULKING THE FASTENERS HEAD.
4. ALL OUTSIDE AND INSIDE CORNERS REQUIRE TWO COMPLETE CORNER APPLICATIONS OF QUICK-APPLIED UNCURED EPDM FLASHING AS PER [DETAILS VGC-15.4A OR VGC-15.7A](#).
5. MAXIMUM 6" (15cm) FASTENER SPACING FOR WARRANTY WIND SPEEDS GREATER THAN 90 MPH OR WARRANTIES EXCEEDING 20 YEARS.

MAXIMUM WARRANTY: 30 YEARS



SHEAR/EXPANSION JOINT

—	→ EPDM MEMBRANE
	→ APPROVED SUBSTRATE
0	→ SEE NOTE(S)

VersiGard COMMON
DETAILS (EPDM)

VGC-3.3

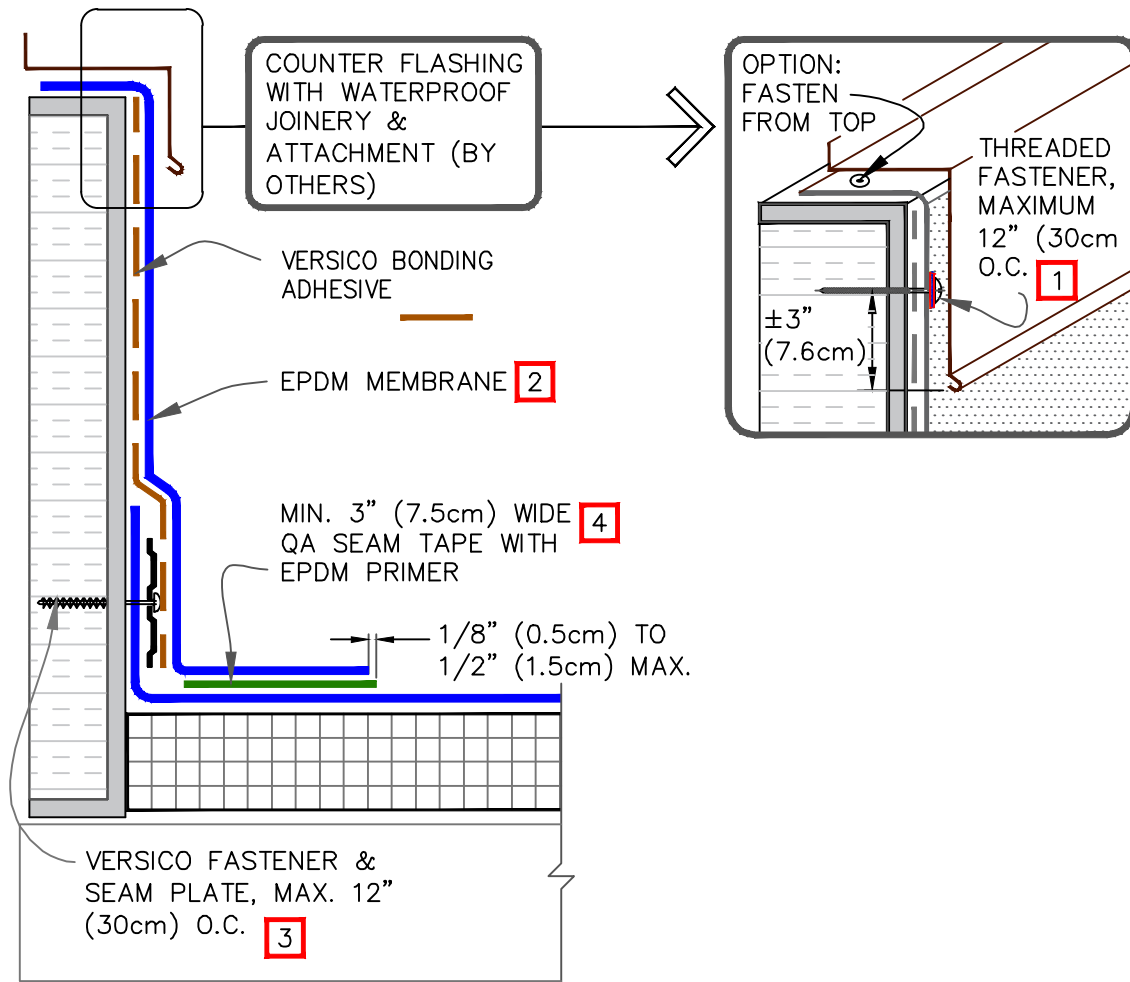

NOTES:

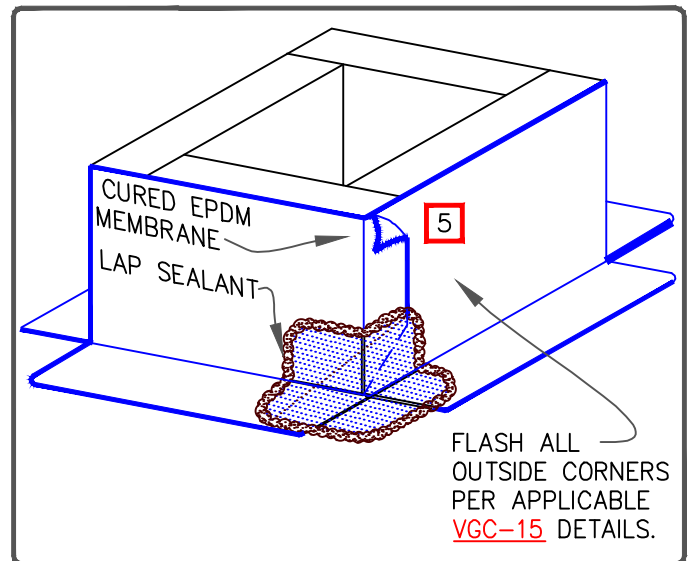

1. IN CASE THE THREADED FASTENERS ARE USED TO PENETRATE THE METAL COUNTER-FLASHING, USE EPDM WASHERS, APPLY WATER CUT-OFF MASTIC UNDER THE COUNTER-FLASHING OR SEAL THE FASTENER HEADS WITH SEALANT.
2. LAP SEALANT IS REQUIRED ON CUT-EDGES OF REINFORCED MEMBRANE.
3. SEAM PLATES AND FASTENERS MAY BE INSTALLED INTO THE STRUCTURAL DECK AND THEN HPV FASTENERS AND POLYMER SEAM PLATES ARE REQUIRED FOR MECHANICALLY-ATTACHED ROOFING SYSTEMS OVER STEEL DECKS.
4. MEMBRANE SPLICES SHALL INCORPORATE 3" (7.6cm) WIDE QA SEAM TAPE FOR PROJECTS WITH 25-YEAR AND 6" (15.2cm) FOR 30-YEAR WARRANTIES.
5. IF THE VERTICAL SPLICE ON THE CURB FLASHING IS NOT LOCATED AT THE CORNER, USE DETAIL [VGC-2.3](#) FOR EPDM MEMBRANE SPLICES AT ANGLE CHANGES.



MAXIMUM WARRANTY: 30 YEARS



CURB FLASHING – EPDM MEMBRANE

 → EPDM MEMBRANE
 → APPROVED SUBSTRATE
 → SEE NOTE(S)

VersiGard COMMON DETAILS (EPDM)

VGC-5.1

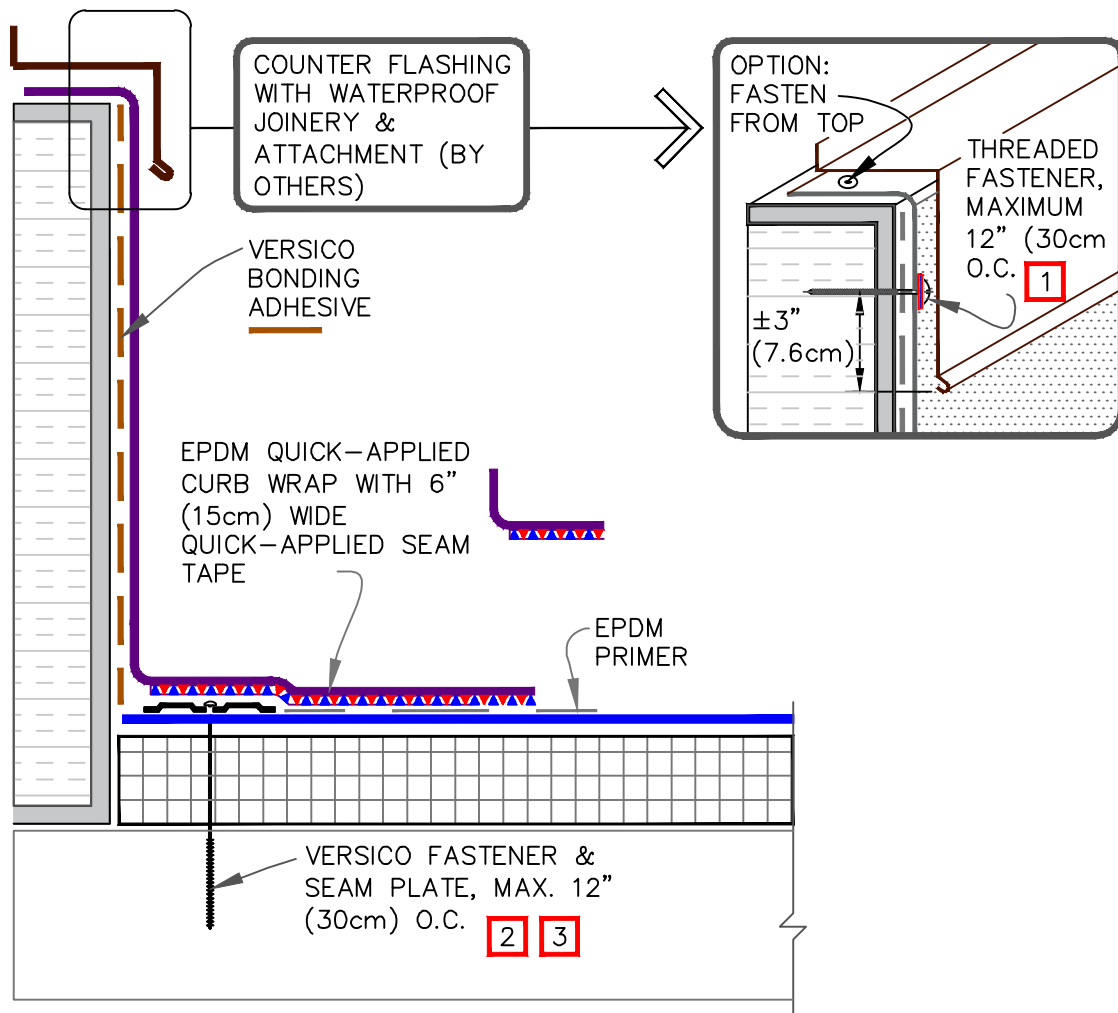

NOTES:

1. IN CASE THE THREADED FASTENERS ARE USED TO PENETRATE THE METAL COUNTER-FLASHING, USE EPDM WASHERS, APPLY WATER CUT-OFF MASTIC UNDER THE COUNTER-FLASHING OR SEAL THE FASTENER HEADS WITH SEALANT.
2. SEAM PLATES AND FASTENERS MAY BE INSTALLED INTO THE VERTICAL SUBSTRATE.
3. HPV FASTENERS AND POLYMER SEAM PLATES ARE REQUIRED FOR MECHANICALLY ATTACHED SYSTEMS OVER STEEL DECKS.
4. IF THE VERTICAL SPLICE ON THE CURB FLASHING IS NOT LOCATED AT THE CORNER, USE DETAIL [VGC-2.3](#) FOR EPDM MEMBRANE SPLICES AT ANGLE CHANGES.

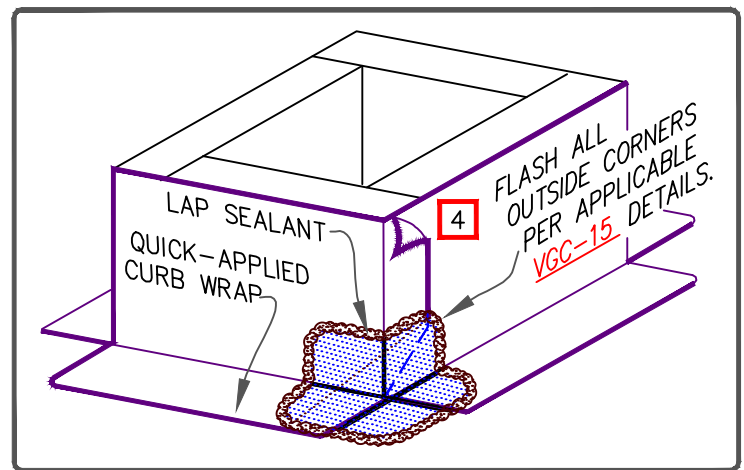

MAXIMUM WARRANTY: 30 YEARS



CURB FLASHING — QUICK-APPLIED CURB WRAP WITH 6" TAPE

- EPDM MEMBRANE
- APPROVED SUBSTRATE
- SEE NOTE(S)

VersiGard COMMON DETAILS (EPDM)

VGC-5.2

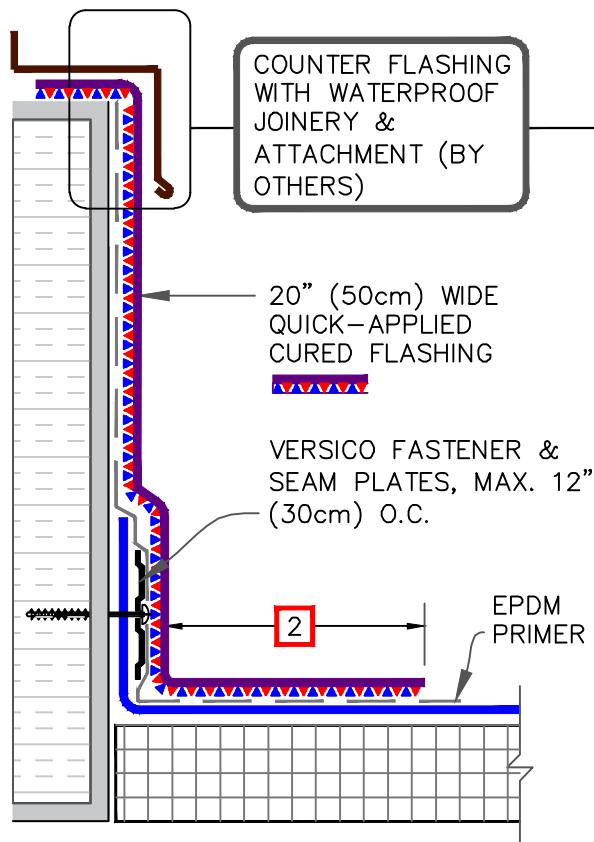

FASTENERS INTO CURB

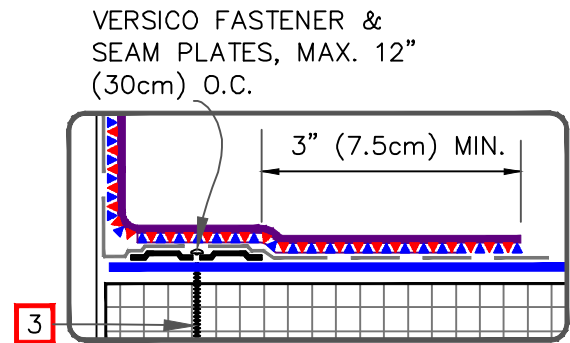
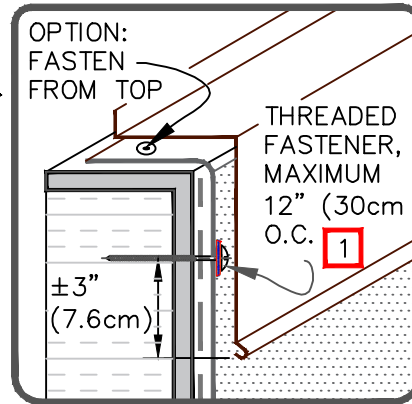

FASTENERS INTO DECK

NOTES:

1. IN CASE THE THREADED FASTENERS ARE USED TO PENETRATE THE METAL COUNTER-FLASHING, USE EPDM WASHERS, APPLY WATER CUT-OFF MASTIC UNDER THE COUNTER-FLASHING OR SEAL THE FASTENER HEADS WITH SEALANT.
2. 3" (7.5cm) FOR UP TO 25 YEARS AND 6" (15cm) FOR 30 YEARS WARRANTY.
3. HPV FASTENERS AND POLYMER SEAM PLATES ARE REQUIRED FOR MECHANICALLY-ATTACHED ROOFING SYSTEMS OVER STEEL DECKS.
4. IF THE VERTICAL SPLICE ON THE CURB FLASHING IS NOT LOCATED AT THE CORNER, USE DETAIL [VGC-2.3](#) FOR EPDM MEMBRANE SPLICES AT ANGLE CHANGES.

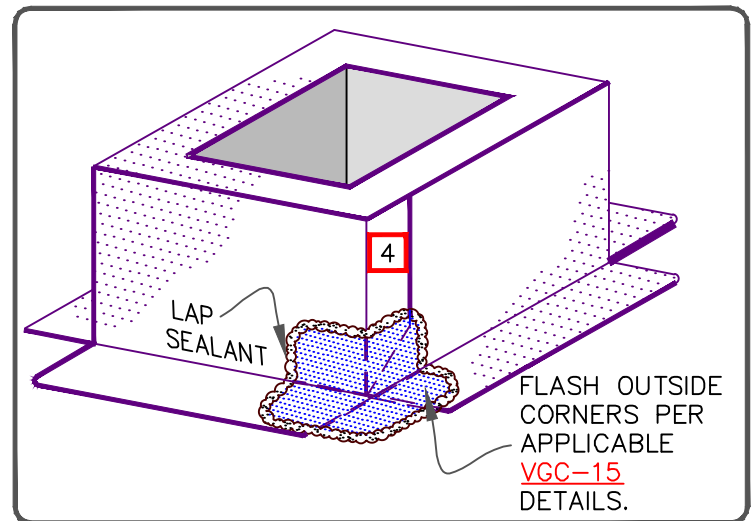

MAXIMUM WARRANTY: 30 YEARS



CURB FLASHING – WITH 20 INCH QUICK-APPLIED CURBED FLASHING

- EPDM MEMBRANE
- APPROVED SUBSTRATE
- SEE NOTE(S)

VersiGard COMMON DETAILS (EPDM)

VGC-5.3

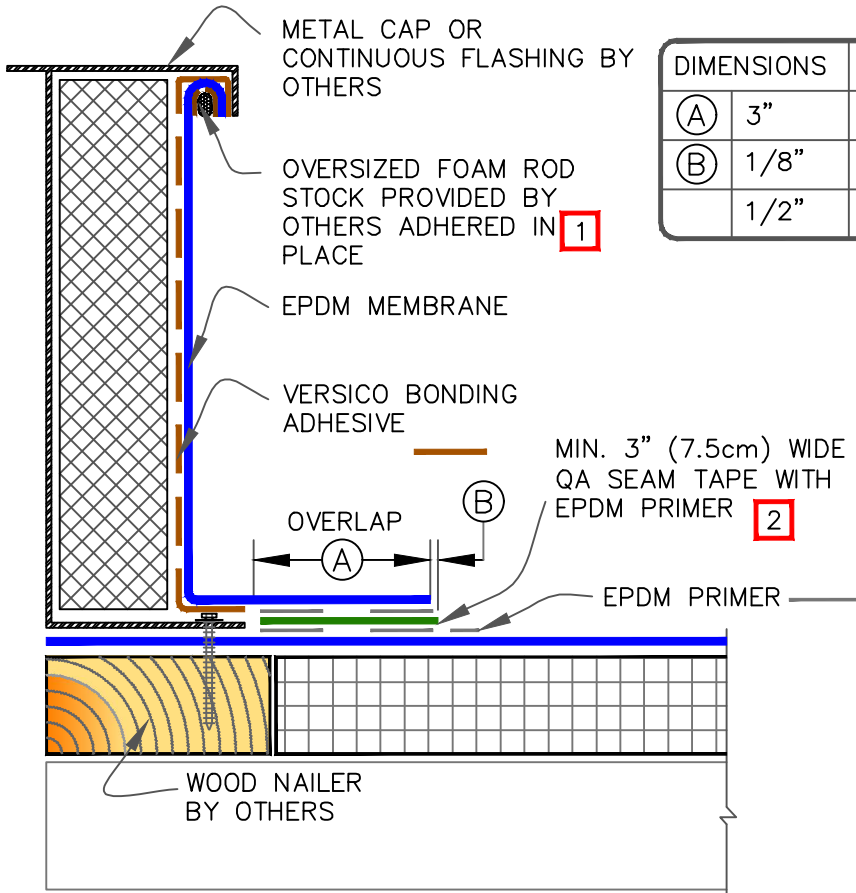

DIMENSIONS		cm	
A	3"	7.5	APPROX.
B	1/8"	0.5	MIN.
	1/2"	1.5	MAX.

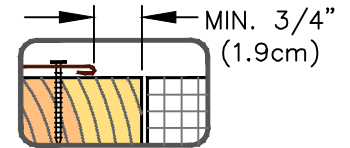

NOTES:

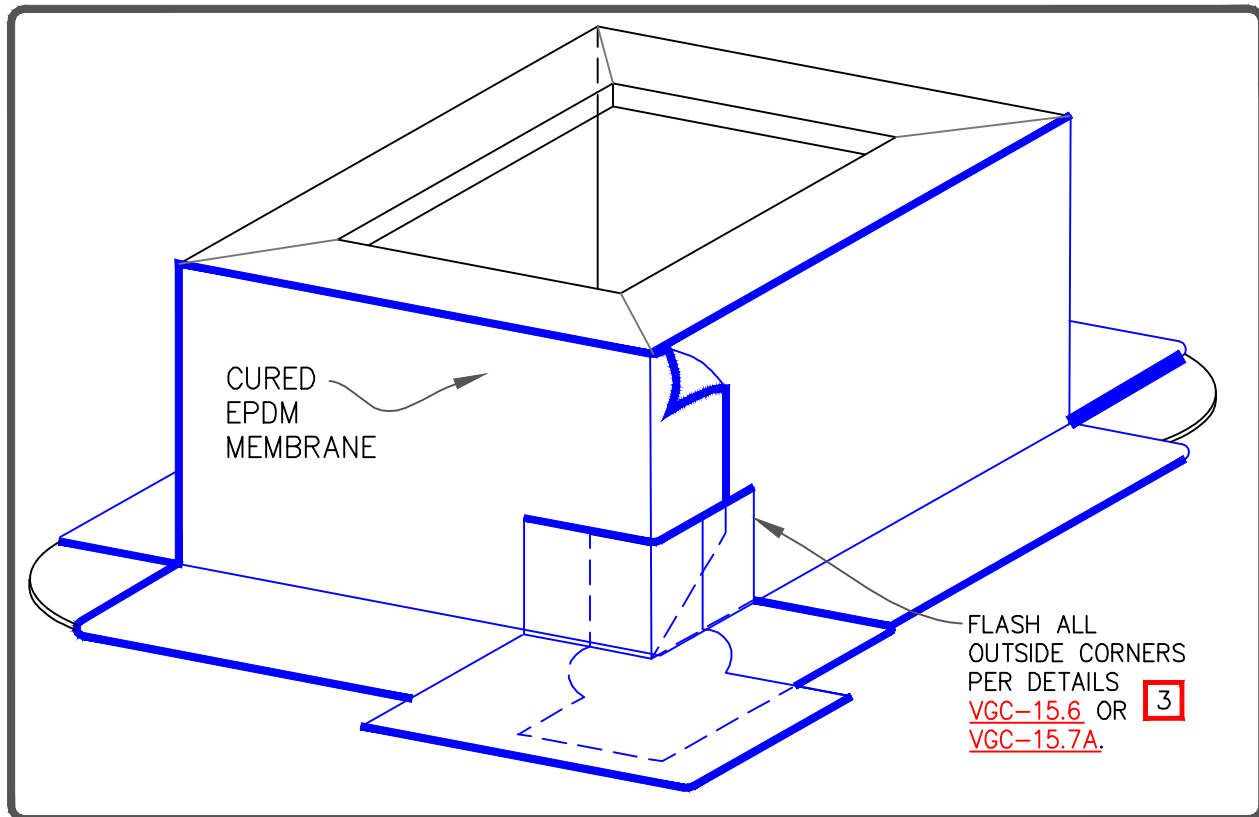

1. LENGTH OF ROD STOCK IS LIMITED TO 4' (1.2m). USE INDIVIDUAL SECTIONS OF ROD STOCK FOR LONGER DIMENSIONS.
2. MEMBRANE SPLICES SHALL INCORPORATE 6" (15cm) WIDE QA SEAM TAPE FOR PROJECTS WITH 25 and 30-YEAR WARRANTIES.
3. WHEN METAL FLANGE IS ON TOP OF MEMBRANE USE DETAIL [VGC-15.6](#) (20 YEAR) OR [VGC-15.7A](#) (25/30 YEAR) TO ACHIEVE SUFFICIENT COVERAGE AT THE CORNERS.
4. DETAIL IS NOT ACCEPTABLE FOR VIBRATING ROOF TOP UNITS.



MAXIMUM WARRANTY: 30 YEARS



SELF-FLASHING CURB

-  → EPDM MEMBRANE
-  → APPROVED SUBSTRATE
-  → SEE NOTE(S)

VersiGard COMMON DETAILS (EPDM)

VGC-5.4

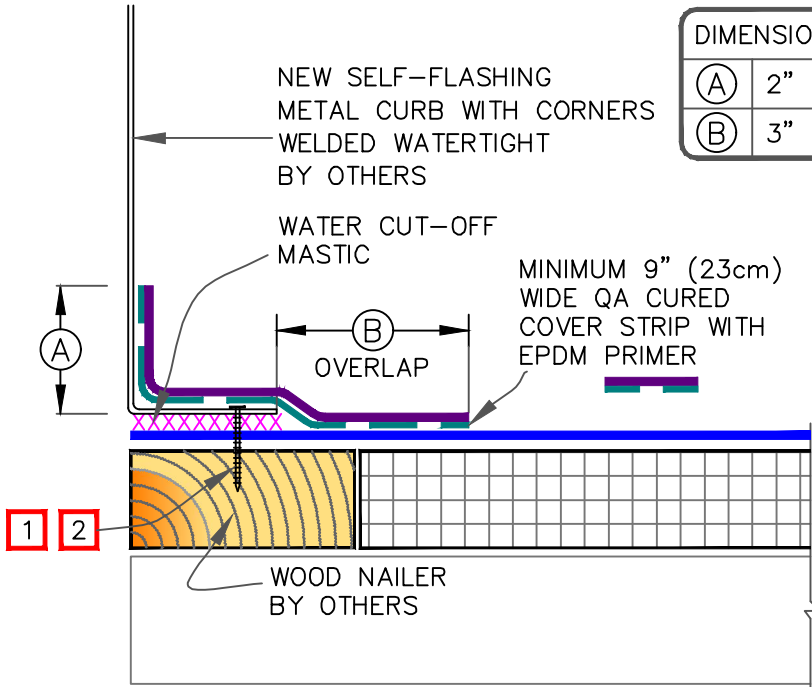

DIMENSIONS		cm	
(A)	2"	5	MIN.
(B)	3"	7.5	APPROX.

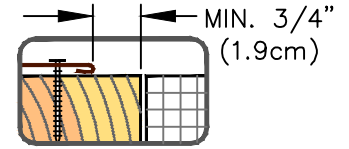

NOTES:

1. CONSULT THE RESPECTIVE MANUFACTURER OF THE SELF-FLASHING METAL CURB FOR PROPER SECUREMENT.
2. WATER CUT-OFF MASTIC MUST BE HELD UNDER CONSTANT COMPRESSION.
3. USE [DETAIL VGC-15.6](#) TO ACHIEVE SUFFICIENT COVERAGE OF METAL FLANGE AT CORNERS.
4. IF THE VERTICAL SPLICE ON THE CURB FLASHING IS NOT LOCATED AT THE CORNER, USE [DETAIL VGC-2.3](#) FOR EPDM MEMBRANE SPLICES AT ANGLE CHANGES.

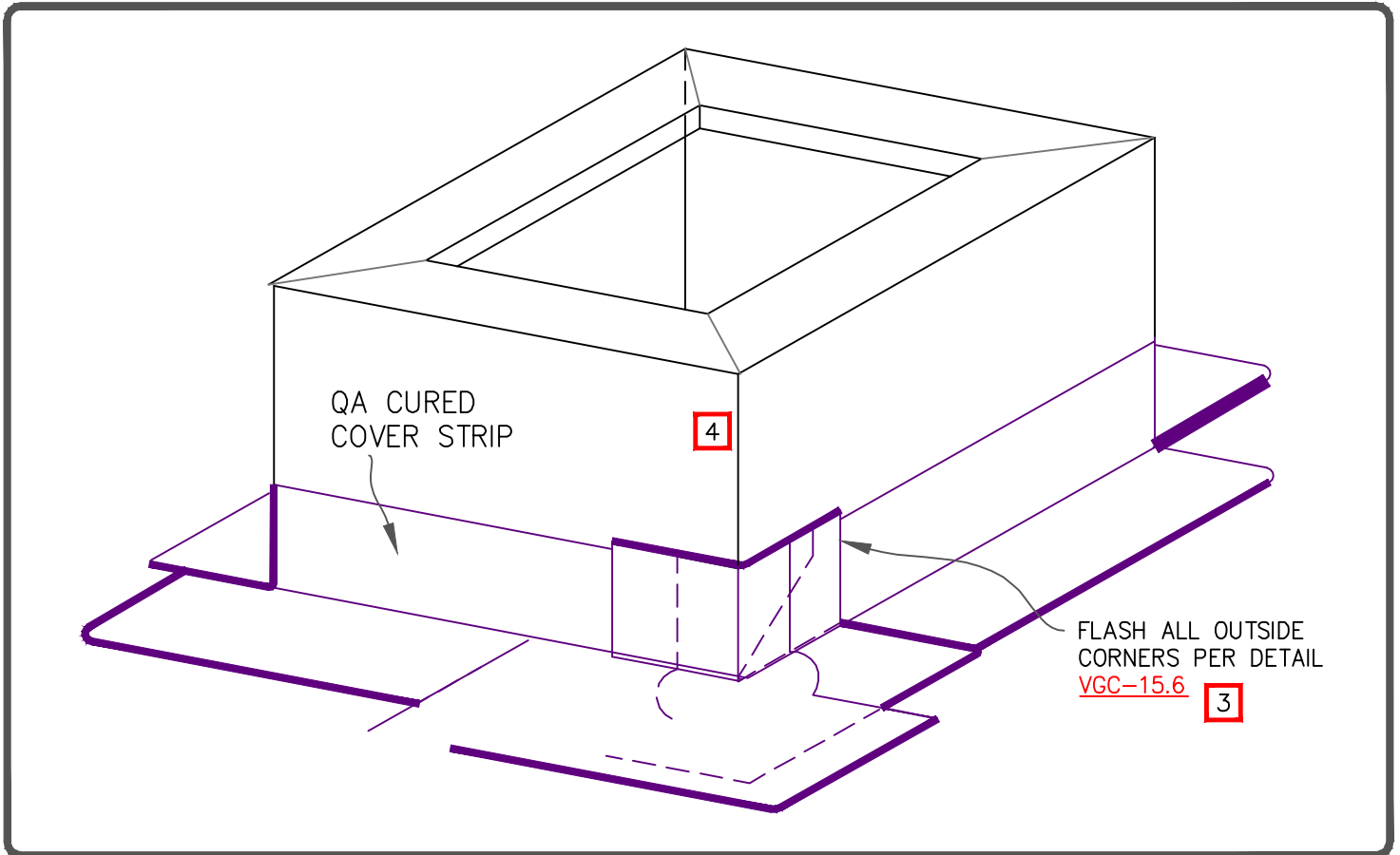

MAXIMUM WARRANTY: 25 YEARS



SELF-FLASHING CURB, ROOF HATCH, OR SKYLIGHT

	→ EPDM MEMBRANE
	→ APPROVED SUBSTRATE
	→ SEE NOTE(S)

VersiGard COMMON DETAILS (EPDM)

VGC-5.5

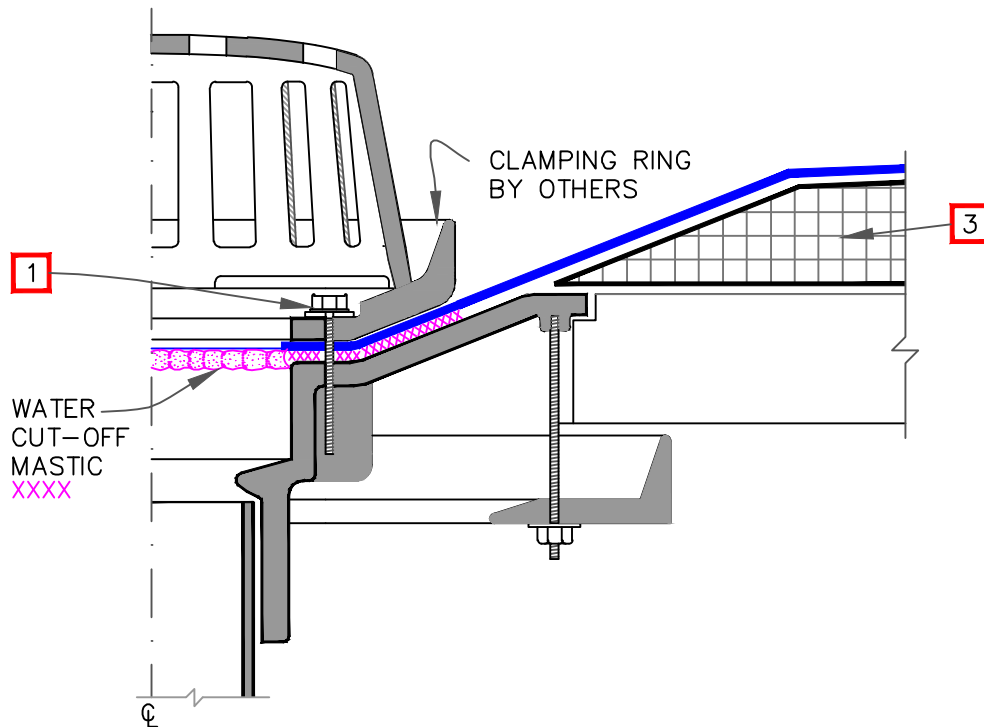

NOTES:

1. ALL BOLTS OR CLAMPS MUST BE IN PLACE TO PROVIDE CONSTANT COMPRESSION ON WATER CUT-OFF MASTIC.
2. REMOVE EXISTING LEAD, FLASHING MATERIAL & ENSURE THE DRAIN RING IS COMPLETELY CLEAN DOWN TO BARE METAL.
3. INSULATION TAPER SHALL NOT BE GREATER THAN 6" (15cm) IN 12" (30cm) HORIZONTAL. REINFORCED EPDM IS LIMITED TO A TAPER LESS THAN 3" (7.5cm) PER FOOT. IF GREATER USE DETAIL [VGC-6.2](#).
4. THE HOLE IN THE MEMBRANE SHALL EXCEED THE DIAMETER OF THE DRAIN PIPE, BUT SHALL BE NO LESS THAN 1/2" (1.5cm) FROM THE ATTACHMENT POINTS OF THE DRAIN CLAMPING RING.
5. FIELD SPLICES MUST BE LOCATED AT LEAST 6" (15cm) OUTSIDE THE DRAIN SUMP.
6. ROOF DRAIN SIZE AND NUMBER OF DRAINS SHALL BE IN ACCORDANCE WITH THE LOCAL CODES.

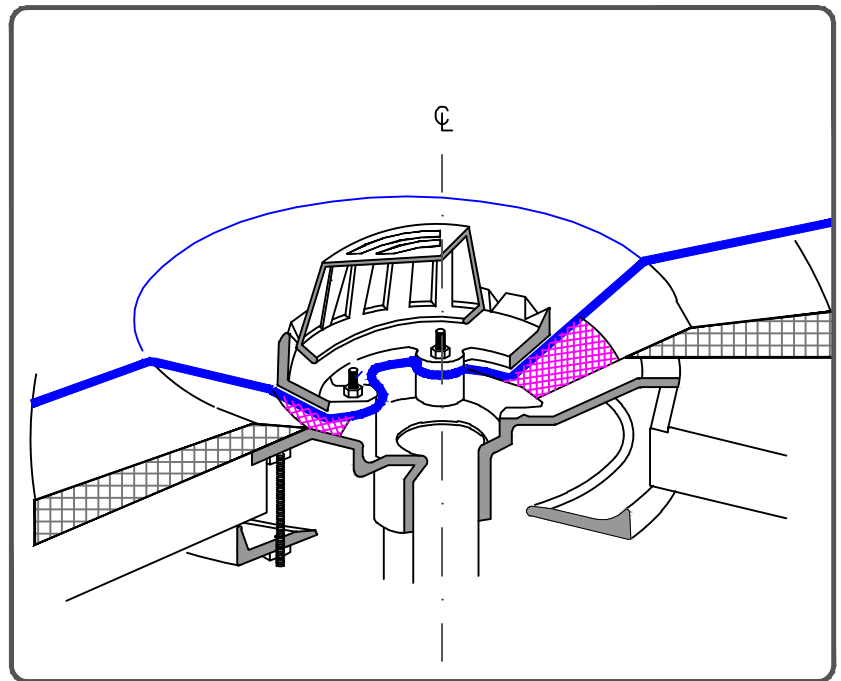
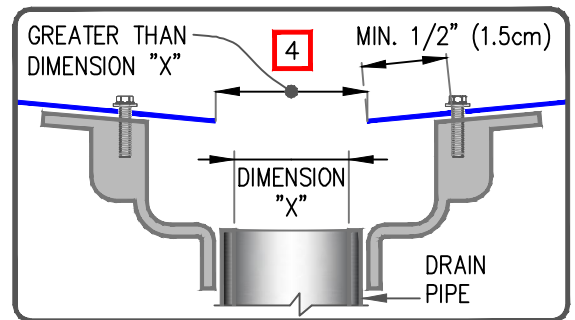

MAXIMUM WARRANTY: 30 YEARS



ROOF DRAIN

	→ EPDM MEMBRANE
	→ APPROVED SUBSTRATE
	→ SEE NOTE(S)

VersiGard COMMON DETAILS (EPDM)

VGC-6.1

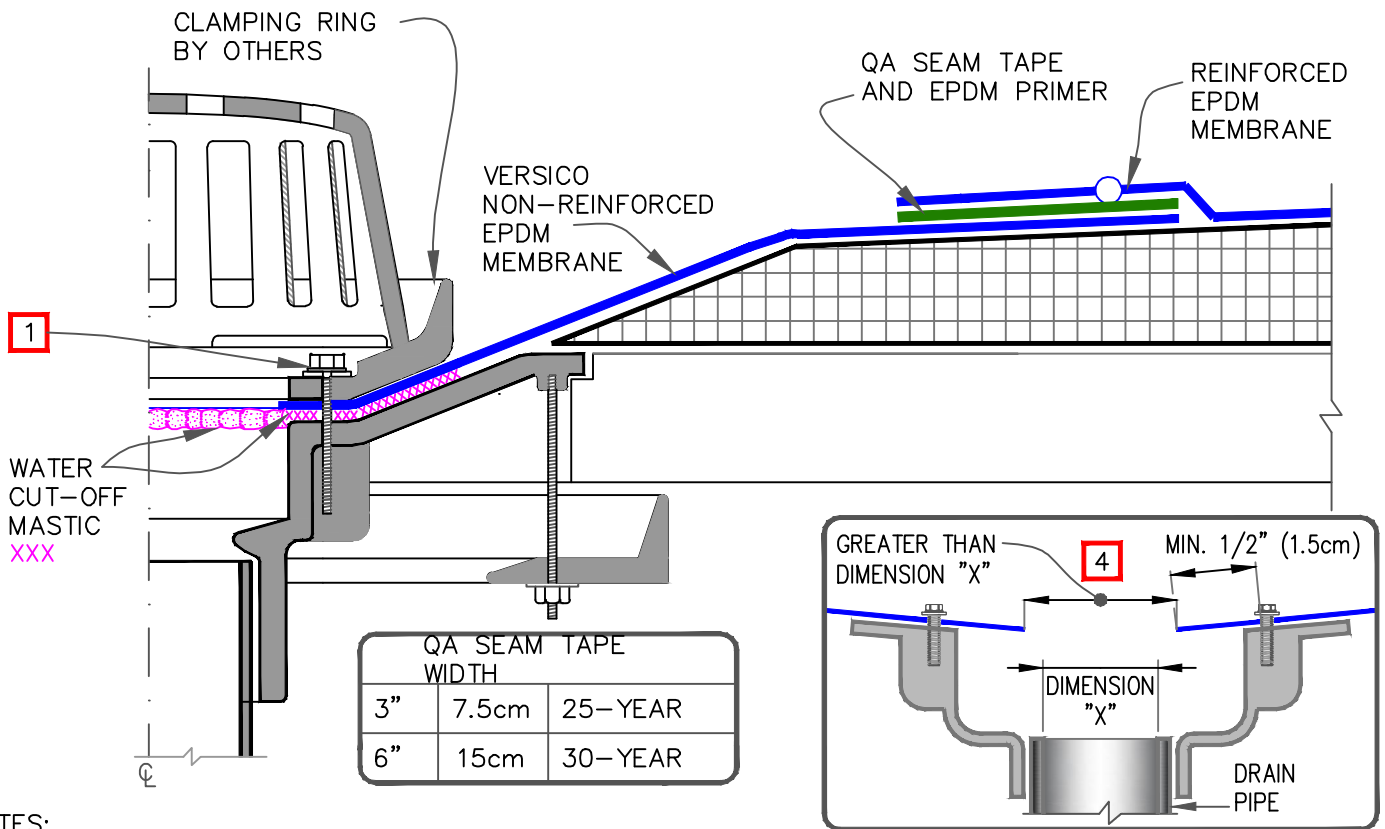



NOTES:

1. ALL BOLTS OR CLAMPS MUST BE IN PLACE TO PROVIDE CONSTANT COMPRESSION ON WATER CUT-OFF MASTIC.
2. REMOVE EXISTING LEAD, FLASHING MATERIAL & ENSURE THE DRAIN RING IS COMPLETELY CLEAN DOWN TO BARE METAL.
3. USE DETAIL [VGMA-6.0](#) FOR MECHANICALLY-ATTACHED SYSTEMS.
4. THE HOLE IN THE MEMBRANE SHALL EXCEED THE DIAMETER OF THE DRAIN PIPE, BUT SHALL BE NO LESS THAN 1/2" (1.5cm) FROM THE ATTACHMENT POINTS OF THE DRAIN CLAMPING RING.
5. ROOF DRAIN SIZE AND NUMBER OF DRAINS SHALL BE IN ACCORDANCE WITH THE LOCAL CODES.
6. FIELD SPLICES MUST BE LOCATED AT LEAST 6" (15cm) OUTSIDE THE DRAIN SUMP.
7. VERSICO RECOMMENDS THE DRAIN TARGET SPLICE BE SHINGLED
 - 7.1. CUT A SQUARE HOLE IN THE FIELD SHEET TO BE AT LEAST 6" (15cm) OUTSIDE THE DRAIN SUMP
 - 7.2. APPLY PRIMER AND QA SEAM TAPE TO THE BOTTOM OF THE FIELD SHEET
 - 7.3. PRIME THE TARGET PIECE OF NR EPDM
 - 7.4. MATE THE TARGET TO THE TAPE
 - 7.5. APPLY BONDING ADHESIVE TO ADHERE FIELD AND TARGET MEMBRANE TO THE SUBSTRATE

MAXIMUM WARRANTY: 30 YEARS



ROOF DRAIN – REINFORCED FIELD SHEET WITH SUMP EXCEEDING 3" PER FOOT

-  → EPDM MEMBRANE
-  → APPROVED SUBSTRATE
-  → SEE NOTE(S)

VersiGard COMMON DETAILS (EPDM)

VGC-6.2

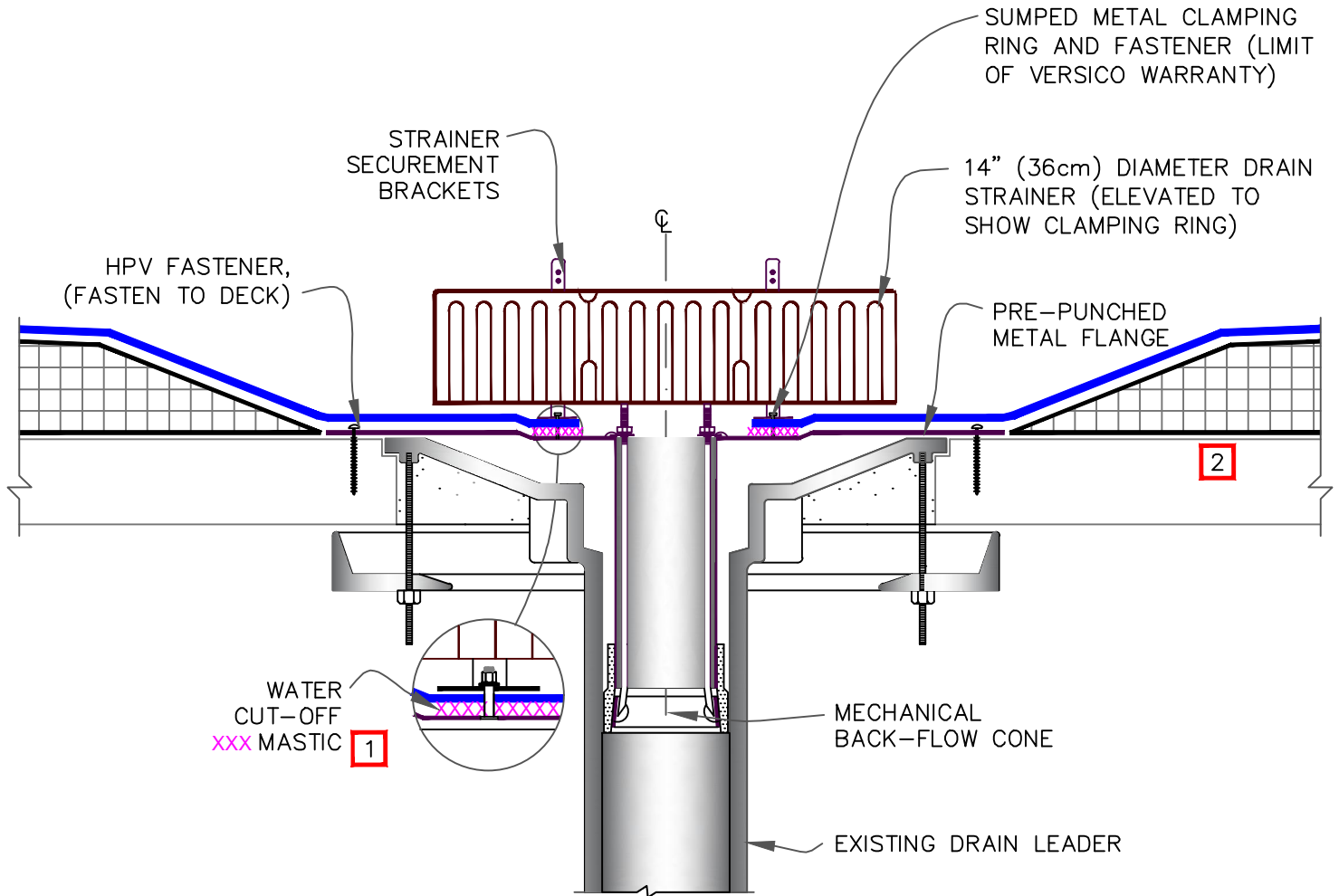

NOTES:

1. ALL BOLTS OR CLAMPS MUST BE IN PLACE TO PROVIDE CONSTANT COMPRESSION ON WATER CUT-OFF MASTIC.
2. INSULATION TAPER SHALL NOT BE GREATER THAN 6" (15cm) IN 12" (30cm) HORIZONTAL.
3. THE HOLE IN THE MEMBRANE SHALL EXCEED THE DIAMETER OF THE DRAIN PIPE, BUT SHALL BE NO LESS THAN 1/2" (1.5cm) FROM THE ATTACHMENT POINTS OF THE DRAIN CLAMPING RING.
4. FIELD SPLICES MUST BE LOCATED AT LEAST 6" (15cm) OUTSIDE THE DRAIN SUMP.
5. ROOF DRAIN SIZE AND NUMBER OF DRAINS SHALL BE IN ACCORDANCE WITH THE LOCAL CODES.

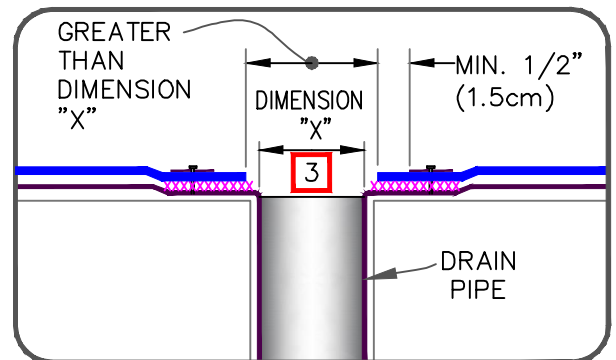

MAXIMUM WARRANTY: 30 YEARS



VERSIGARD INSERT DRAIN

	→ EPDM MEMBRANE
	→ APPROVED SUBSTRATE
	→ SEE NOTE(S)

VersiGard COMMON DETAILS (EPDM)

VGC-6.3

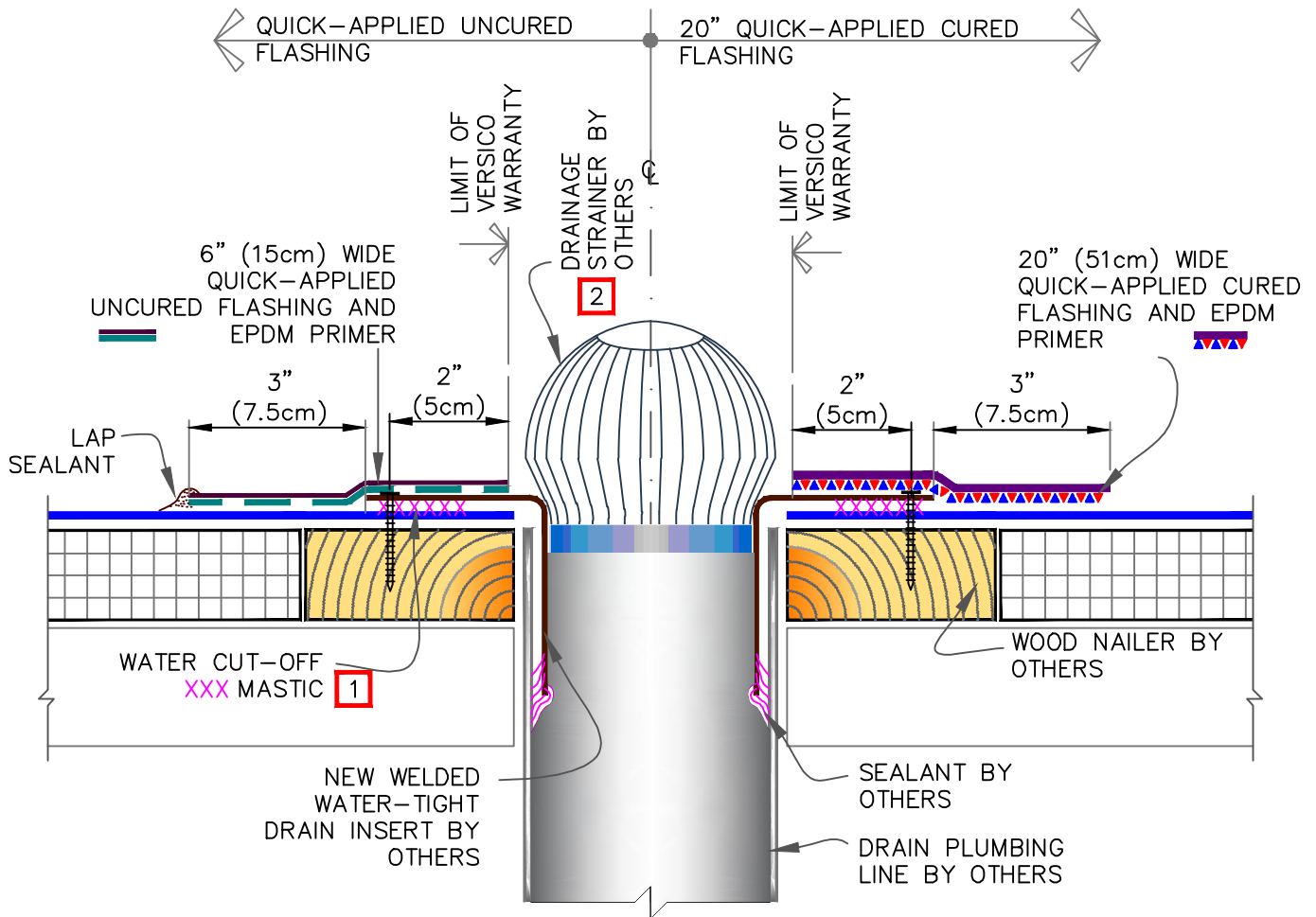

NOTES:

1. WATER CUT-OFF MASTIC MUST BE UNDER CONSTANT COMPRESSION.
2. CONSULT SPECIFIER OR APPLICABLE CODES FOR ADEQUATE DRAINAGE STRAINER TO AVOID PONDING WATER. DO NOT RESTRICT WATER FLOW.
3. FOR PROJECTS WITH 30-YEAR WARRANTIES, THE DRAIN INSERT FLANGE MUST BE OVERLAID WITH TWO LAYERS OF QUICK-APPLIED FLASHING. THE BOTTOM LAYER SHALL BE 6" (15cm) WIDE QUICK-APPLIED UNCURED OR CURED COVER STRIP COVERED WITH A 9" (23cm) WIDE TOP LAYER OF QUICK-APPLIED UNCURED FLASHING. SEAL TOP LAYER WITH CONTINUOUS LAP SEALANT.

MAXIMUM WARRANTY: 30 YEARS (SEE NOTE 3)



INSERT DRAIN THROUGH DECK

	→ EPDM MEMBRANE
	→ APPROVED SUBSTRATE
	→ SEE NOTE(S)

VersiGard COMMON DETAILS (EPDM)

VGC-6.4

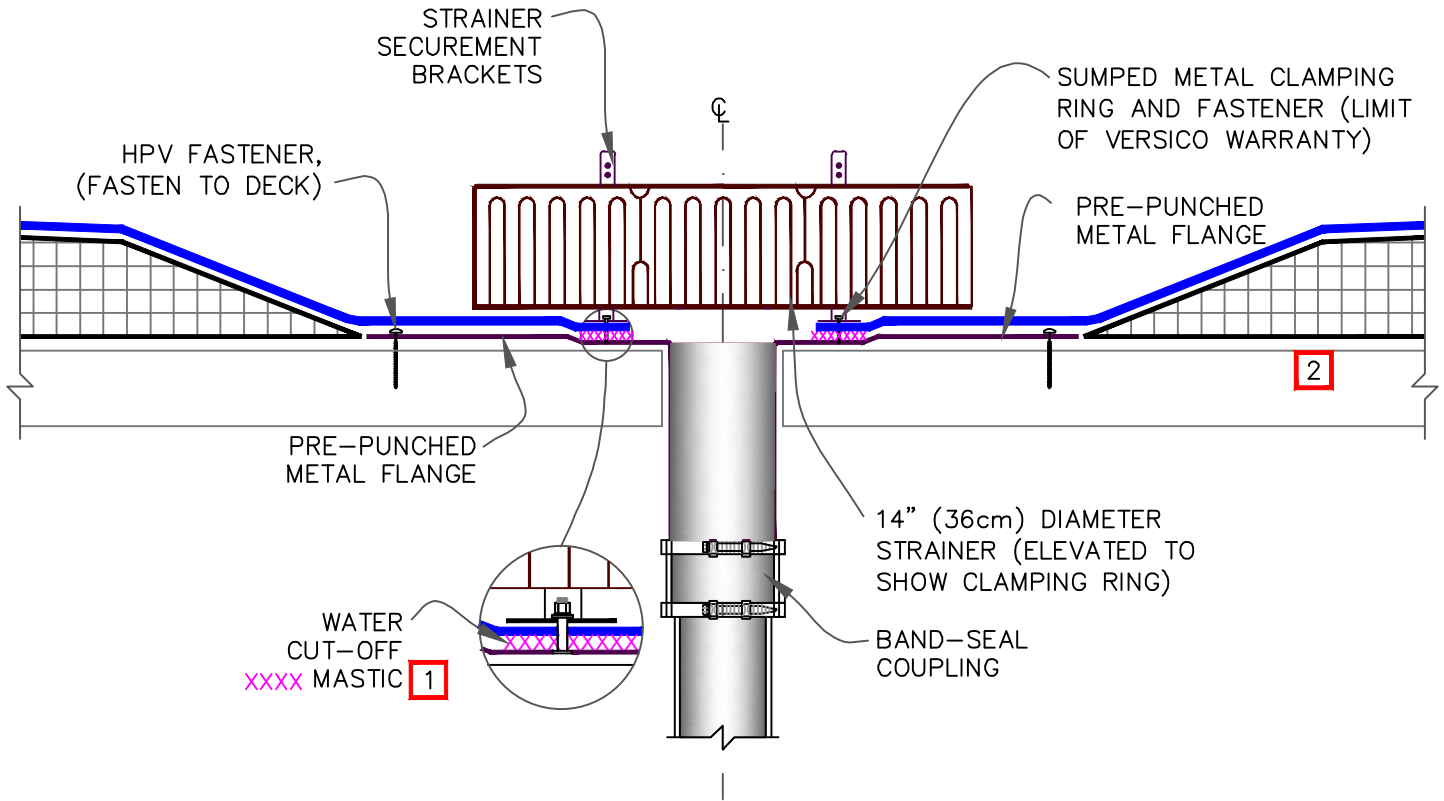

NOTES:

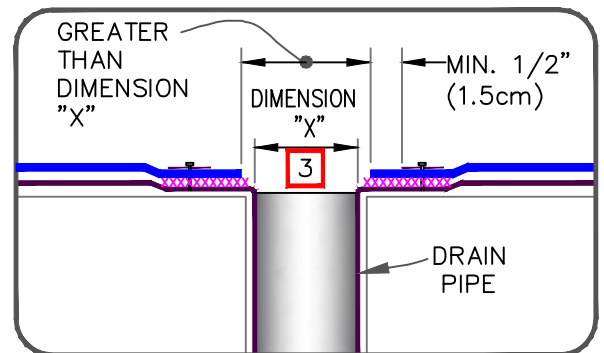

1. ALL BOLTS OR CLAMPS MUST BE IN PLACE TO PROVIDE CONSTANT COMPRESSION ON WATER CUT-OFF MASTIC.
2. INSULATION TAPER SHALL NOT BE GREATER THAN 6" (15cm) IN 12" (30cm) HORIZONTAL.
3. THE HOLE IN THE MEMBRANE SHALL EXCEED THE DIAMETER OF THE DRAIN PIPE, BUT SHALL BE NO LESS THAN 1/2" (1.5cm) FROM THE ATTACHMENT POINTS OF THE DRAIN CLAMPING RING.
4. FIELD SPLICES MUST BE LOCATED AT LEAST 6" (15cm) OUTSIDE THE DRAIN SUMP.
5. ROOF DRAIN SIZE AND NUMBER OF DRAINS SHALL BE IN ACCORDANCE WITH THE LOCAL CODES.



MAXIMUM WARRANTY: 30 YEARS



VERSIGARD ADD-ON DRAIN

-  → EPDM MEMBRANE
-  → APPROVED SUBSTRATE
-  → SEE NOTE(S)

VersiGard COMMON DETAILS (EPDM)

VGC-6.5

NOTES:

1. REMOVE ALL LEAD AND OTHER FLASHING BEFORE INSTALLING QUICK-APPLIED PIPE SEAL.
2. TEMPERATURE OF PIPE PENETRATION MUST NOT EXCEED 180°F (82°C).
3. PRE-MOLDED PIPE FLASHING MUST HAVE RIB INTACT AT THE TOP EDGE REGARDLESS OF PIPE DIAMETER.
4. DECK FLANGES OF THE QUICK-APPLIED PIPE SEAL SHALL NOT BE OVERLAPPED, CUT OR APPLIED OVER ANY ANGLE CHANGE.
5. USE DETAIL [VGC-8.1A](#) WHEN PIPE BOOT INTERSECTS A SPLICE ON 30-YEAR WARRANTY.
6. ON MECHANICALLY-ATTACHED ROOFING SYSTEMS, REFER TO [DETAIL VGMA-8.1](#).

DIMENSIONS	cm	
(A) 1/2"	1.5	TO
6"	15	
(B) 3"	7.5	

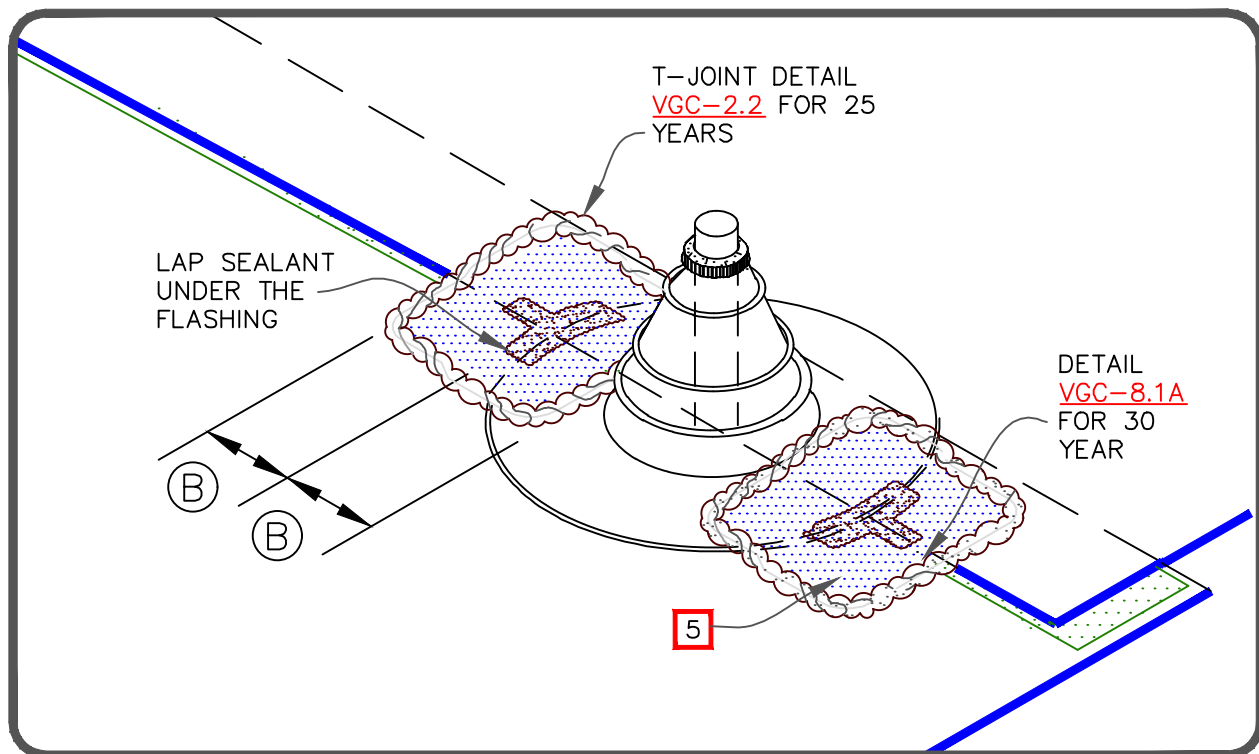
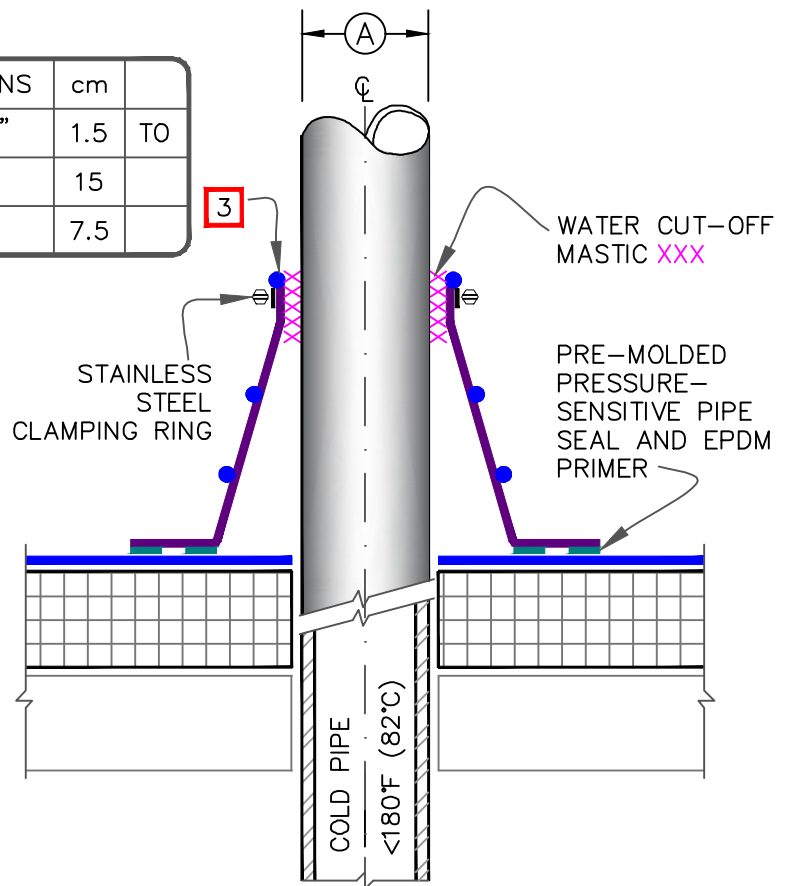

MAXIMUM WARRANTY: 30 YEARS



QUICK-APPLIED PIPE SEAL

	→ EPDM MEMBRANE
	→ APPROVED SUBSTRATE
	→ SEE NOTE(S)

VersiGard COMMON DETAILS (EPDM)

VGC-8.1

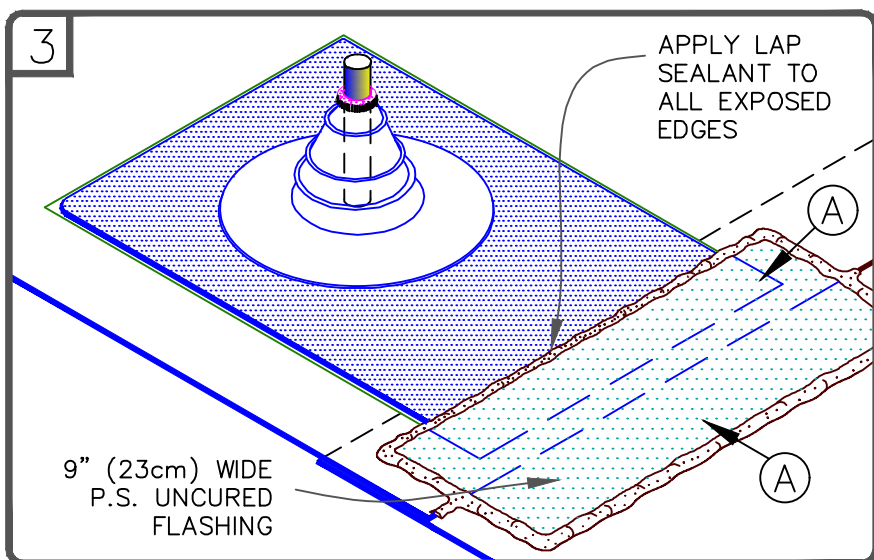
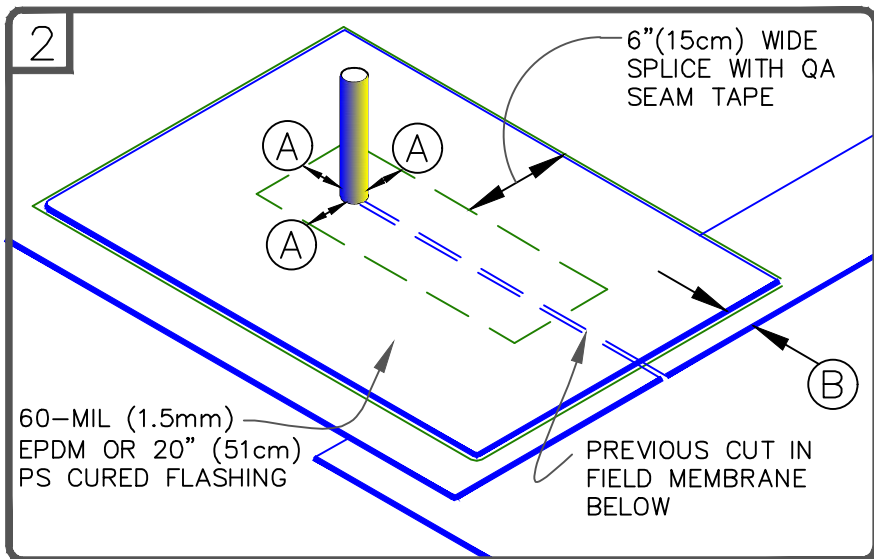
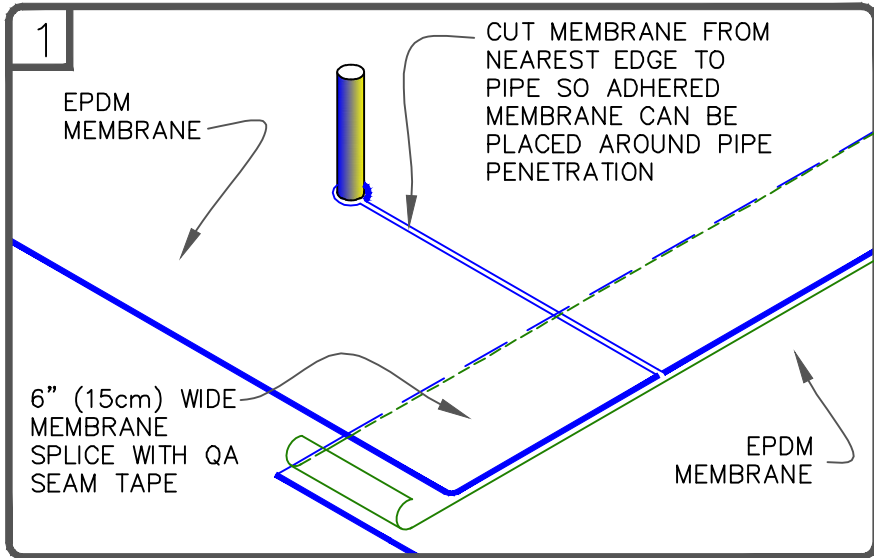

NOTES:

1. THIS DETAIL FOR USE WHEN A RELIEF CUT OR MEMBRANE SPLICE IS PRESENT AT THE PIPE SEAL. USE DETAIL [VGC-8.1](#) WHEN NO CUT OR SPLICE IS PRESENT.
2. REMOVE ALL LEAD AND OTHER FLASHING BEFORE INSTALLING QUICK-APPLIED PIPE SEAL.
3. PIPE SEAL MUST HAVE INTACT RIB AT TOP EDGE, REGARDLESS OF PIPE DIAMETER.
4. DECK FLANGES OF THE MOLDED PIPE SEAL SHALL NOT BE OVERLAPPED, CUT OR APPLIED OVER ANY ANGLE CHANGE.
5. ON MECHANICALLY ATTACHED ROOFING SYSTEMS REFER TO DETAIL [VGMA-8.3](#).
6. MEMBRANE SECUREMENT IS REQUIRED AROUND ALL ROUND PIPE PENETRATIONS GREATER THAN 18" (45.7cm) IN DIAMETER.

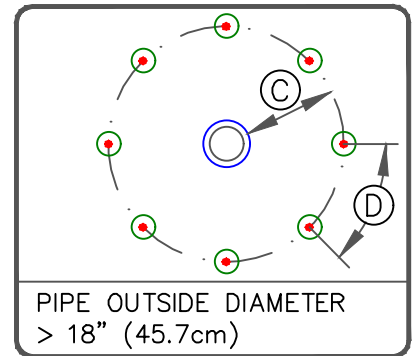

DIMENSIONS	cm	
(A)	3"	7.5 MIN.
(B)	1"	2.5 MIN.
(C)	6"-12"	20-30 MIN-MAX
(D)	12"	30 MAX.

MAXIMUM WARRANTY: 30 YEARS



QUICK-APPLIED PIPE SEAL WITH 90-MIL MEMBRANE OR 30 YEAR WARRANTIES

- EPDM MEMBRANE
- APPROVED SUBSTRATE
- SEE NOTE(S)

VersiGard COMMON DETAILS (EPDM)

VGC-8.1A

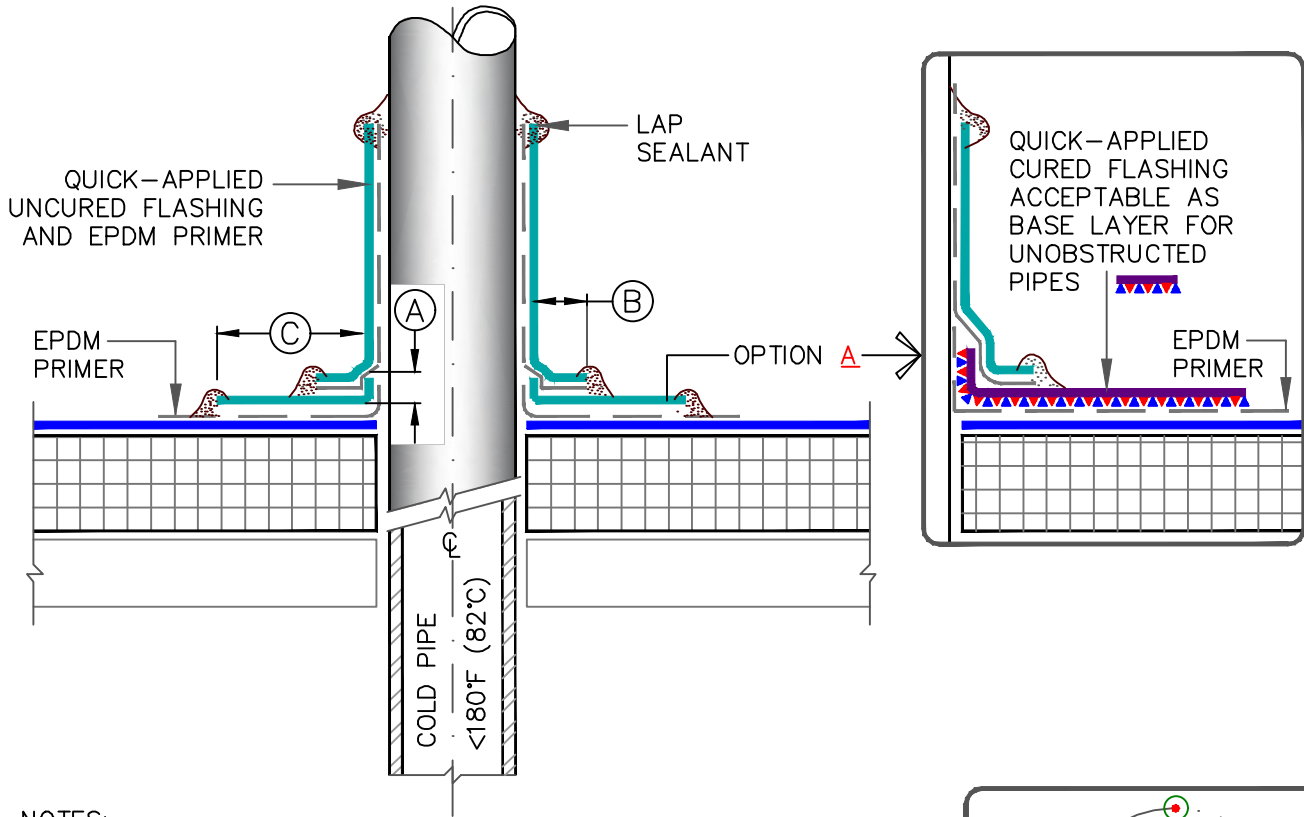

NOTES:

1. REMOVE ALL LEAD AND OTHER FLASHING BEFORE INSTALLING FIELD-FABRICATED FLASHING.
2. TEMPERATURE OF PIPE PENETRATION MUST NOT EXCEED 180°F (82°C).
3. ACCEPTABLE WITH SQUARE OR RECTANGULAR STRUCTURAL TUBING WITH ROUNDED CORNERS UP TO 12”(30cm). USE [DETAIL VGC-5](#) IF GREATER THAN 12” (30cm).
4. IN COLDER TEMPERATURES, A HEAT GUN MUST BE USED WHEN FORMING QUICK-APPLIED UNCURED EPDM OR CURED FLASHING.
5. ON MECHANICALLY ATTACHED ROOFING SYSTEMS. REFER TO [DETAIL VGMA-8.2](#).
6. MEMBRANE SECUREMENT IS REQUIRED AROUND ALL ROUND PIPE PENETRATIONS GREATER THAN 18” (46cm) IN DIAMETER.

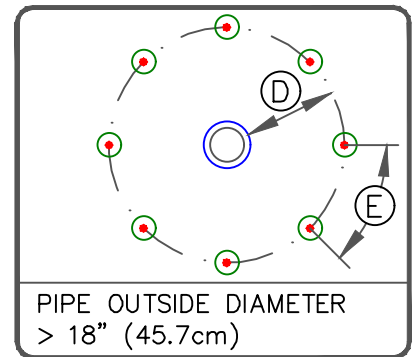

DIMENSIONS		cm	
(A)	1/2”	1.5	MIN.
(B)	1”	2.5	MIN.
(C)	3”	7.5	MIN.
(D)	6”-12”	20-30	MIN-MAX
(E)	12”	30	MAX.

MAXIMUM WARRANTY: 20 YEARS



FIELD FABRICATED PIPE WRAP

- EPDM MEMBRANE
- APPROVED SUBSTRATE
- SEE NOTE(S)

VersiGard COMMON DETAILS (EPDM)

VGC-8.2

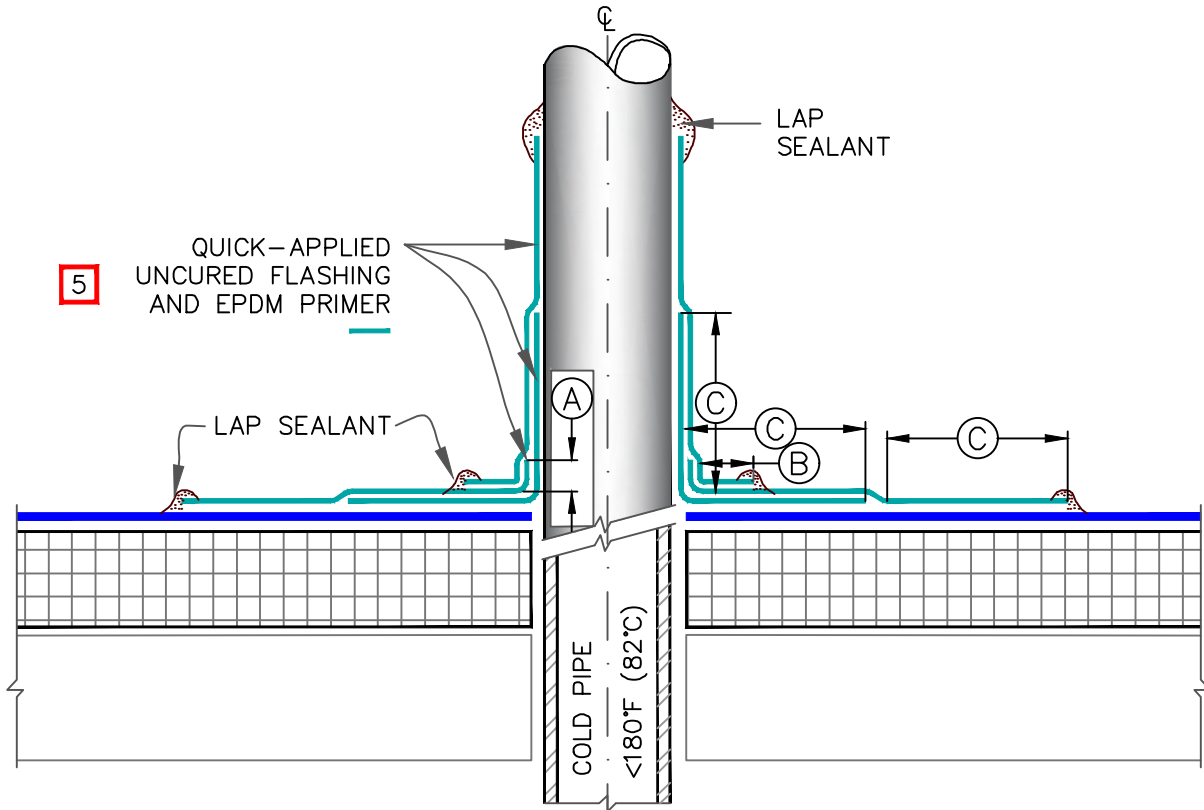

NOTES:

1. REMOVE ALL LEAD AND OTHER FLASHING BEFORE INSTALLING FIELD-FABRICATED FLASHING.
2. TEMPERATURE OF PIPE PENETRATION MUST NOT EXCEED 180°F (82°C).
3. PIPE FLASHING MAY BE USED WITH SQUARE OR RECTANGULAR STRUCTURAL TUBING WITH ROUNDED CORNERS.
4. FOR STRUCTURAL STEEL TUBING GREATER THAN 12" (30cm) ACROSS, USE [DETAIL\(S\) VGC-5.](#)
5. IN COLDER TEMPERATURES, A HEAT GUN MUST BE USED WHEN FORMING QUICK-APPLIED UNCURED EPDM FLASHING.
6. ON MECHANICALLY ATTACHED ROOFING SYSTEMS, REFER TO [DETAIL VGMA-8.2.](#)
7. MEMBRANE SECUREMENT IS REQUIRED AROUND ALL ROUND PIPE PENETRATIONS GREATER THAN 18" (46cm) IN DIAMETER.

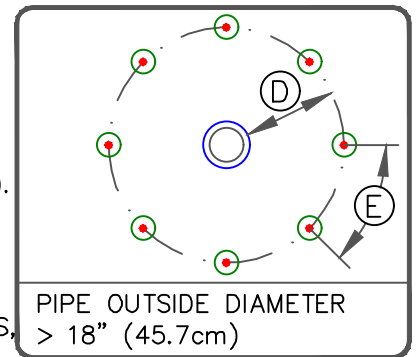

DIMENSIONS		cm	
(A)	1/2"	1.5	MIN.
(B)	1"	2.5	MIN.
(C)	3"	7.5	MIN.
(D)	6"-12"	20-30	MIN-MAX
(E)	12"	30	MAX.

MAXIMUM WARRANTY: 30 YEARS



FIELD FABRICATED PIPE WRAP (30 YEAR WARRANTIES)

- █ → EPDM MEMBRANE
- APPROVED SUBSTRATE
- 5 → SEE NOTE(S)

VersiGard COMMON DETAILS (EPDM)

VGC-8.2A

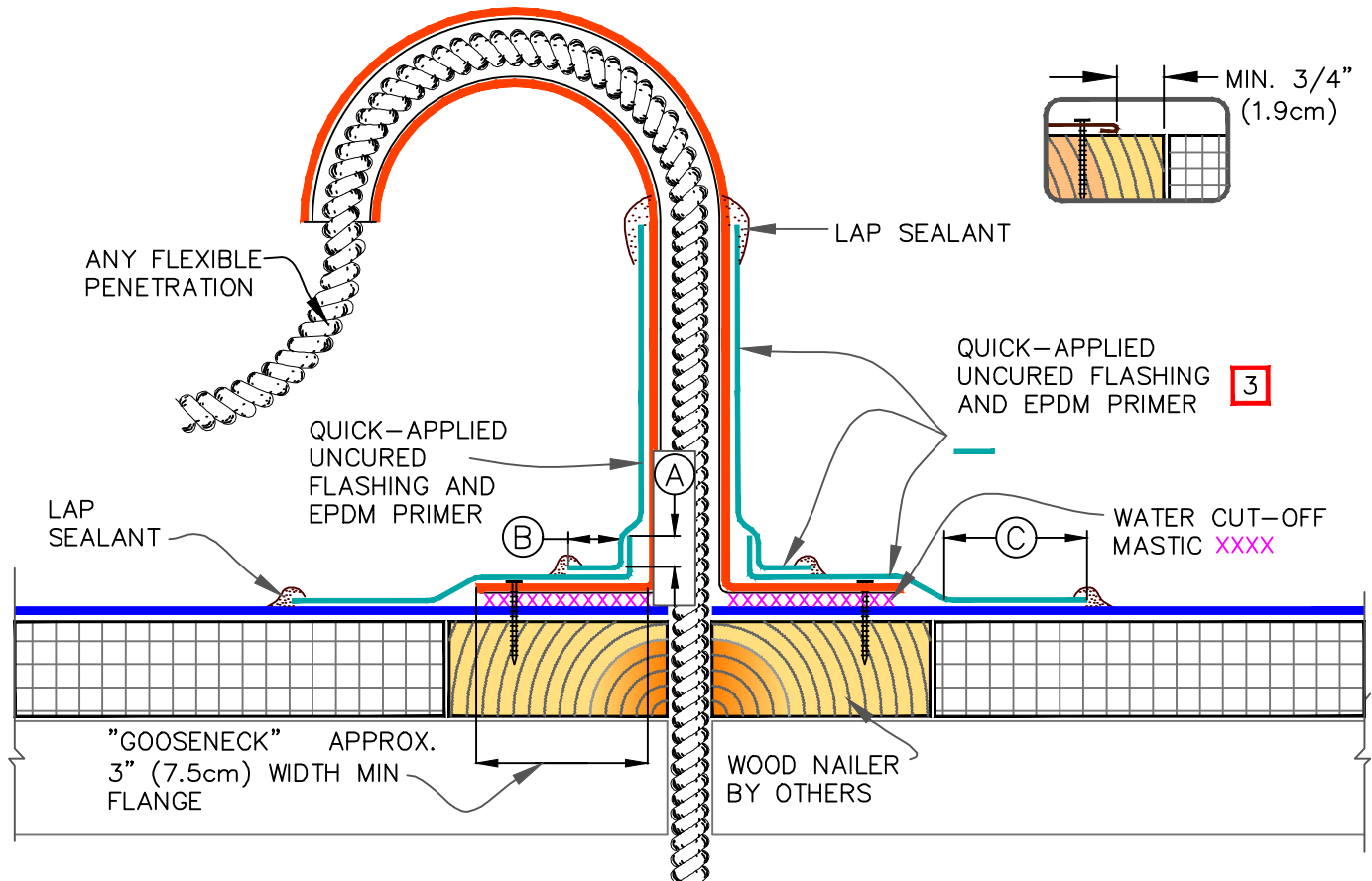

NOTES:

1. REMOVE ALL LEAD AND OTHER FLASHING BEFORE INSTALLING FIELD-FABRICATED PIPE SEAL.
2. TEMPERATURE OF PENETRATION MUST NOT EXCEED 180°F (82°C).
3. IN COLDER TEMPERATURES, A HEAT GUN MUST BE USED WHEN FORMING QUICK-APPLIED UNCURED FLASHING.

DIMENSIONS	cm	
(A) 1/2"	1.5	MIN.
(B) 1"	2.5	MIN.
(C) 3"	7.5	MIN.

MAXIMUM WARRANTY: 20 YEARS



FLEXIBLE PENETRATION

- █ → EPDM MEMBRANE
- APPROVED SUBSTRATE
- 0 → SEE NOTE(S)

VersiGard COMMON DETAILS (EPDM)

VGC-8.3

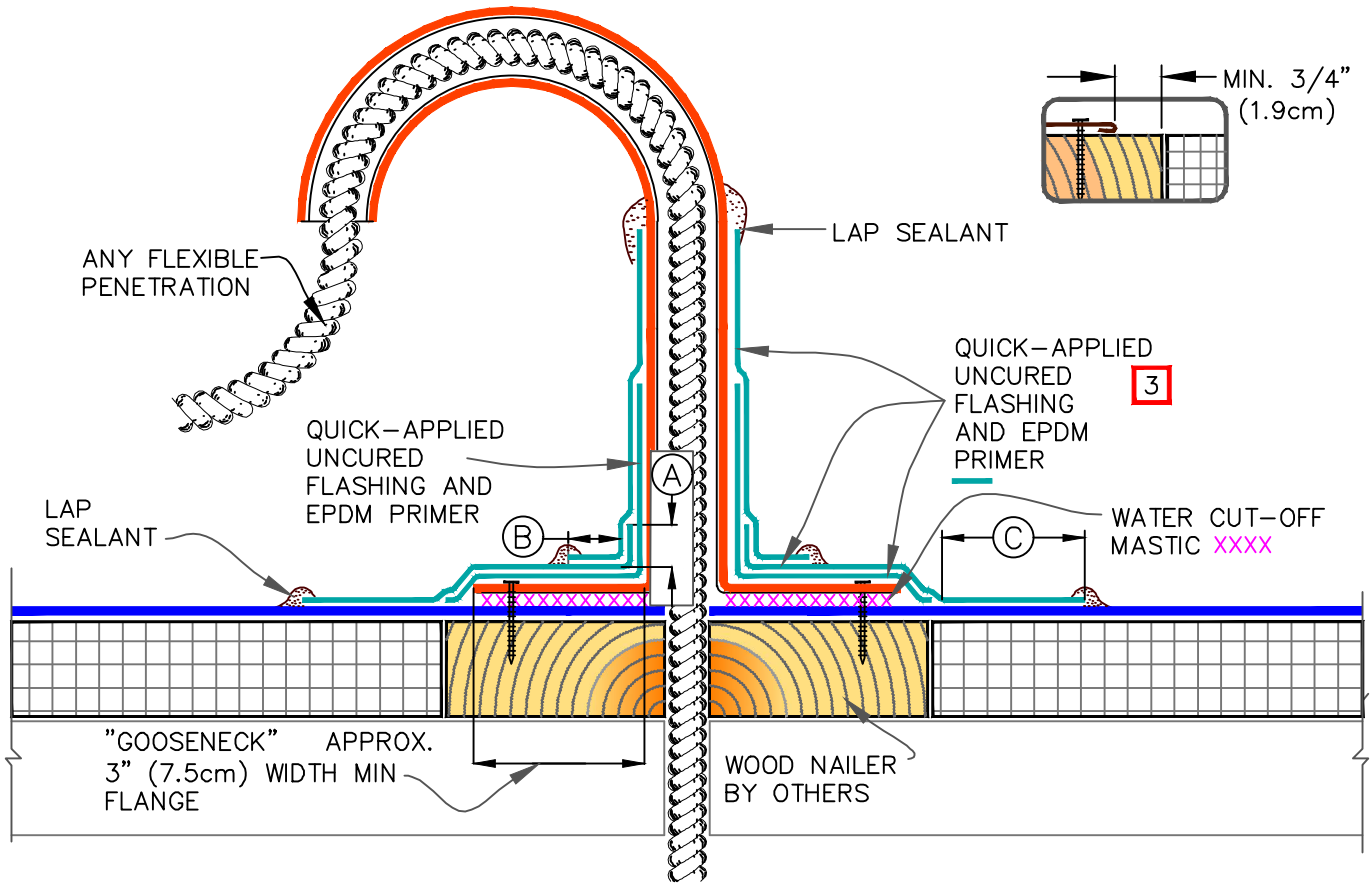

NOTES:

1. REMOVE ALL LEAD AND OTHER FLASHING BEFORE INSTALLING FIELD-FABRICATED PIPE SEAL.
2. TEMPERATURE OF PENETRATION MUST NOT EXCEED 180°F (82°C).
3. IN COLDER TEMPERATURES, A HEAT GUN MUST BE USED WHEN FORMING QUICK-APPLIED UNCURED FLASHING.

DIMENSIONS	cm	
(A) 1/2"	1.5	MIN.
(B) 1"	2.5	MIN.
(C) 3"	7.5	MIN.

MAXIMUM WARRANTY: 30 YEARS



FLEXIBLE PENETRATION
(30 YEAR WARRANTY)

█ → EPDM MEMBRANE
█ → APPROVED SUBSTRATE
0 → SEE NOTE(S)

VersiGard COMMON DETAILS (EPDM)
VGC-8.3A

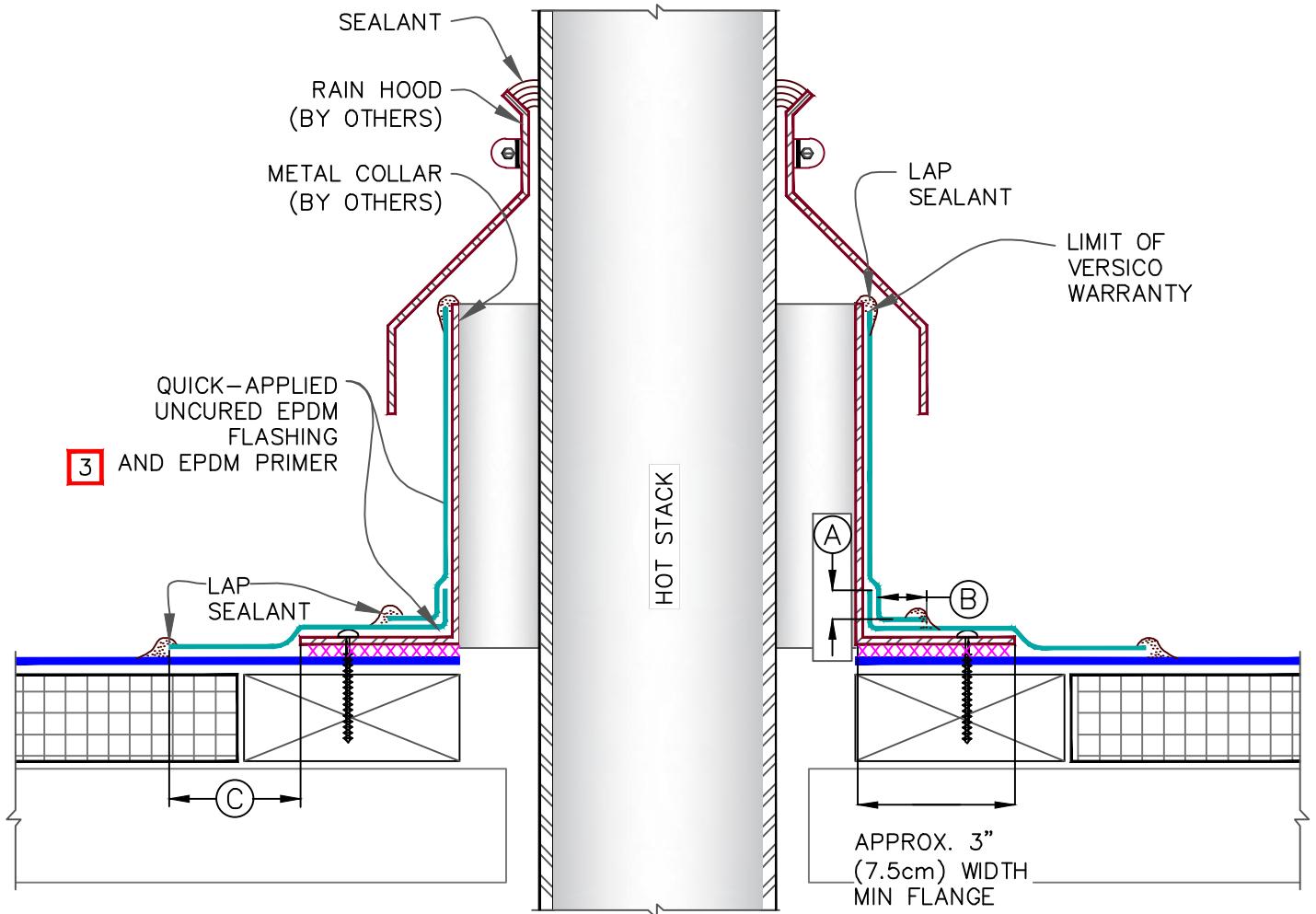

NOTES:



1. REMOVE ALL LEAD AND OTHER FLASHING BEFORE INSTALLING FIELD FABRICATED PIPE SEAL.
2. TEMPERATURE OF METAL COLLAR MUST NOT EXCEED 180°F (82°C).
3. IN COLDER TEMPERATURES, A HEAT GUN MUST BE USED WHEN FORMING QUICK-APPLIED UNCURED FLASHING.

DIMENSIONS		cm	
(A)	1/2"	1.5	MIN.
(B)	1"	2.5	MIN.
(C)	3"	7.5	MIN.

MAXIMUM WARRANTY: 20 YEARS



FIELD FABRICATED HOT STACK

-  → EPDM MEMBRANE
-  → APPROVED SUBSTRATE
-  → SEE NOTE(S)

VersiCard COMMON DETAILS (EPDM)

VGC-8.4

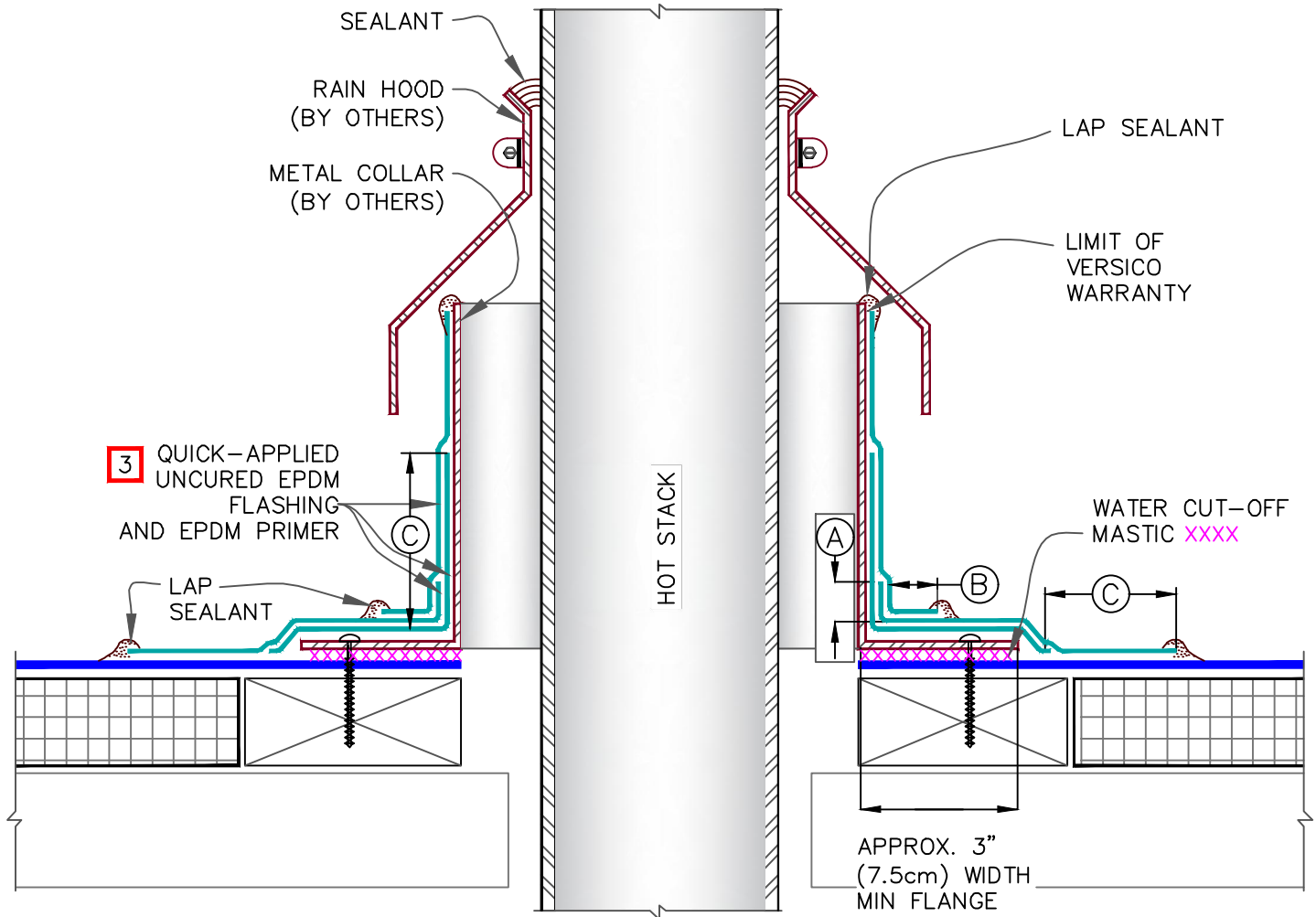

NOTES:



1. REMOVE ALL LEAD AND OTHER FLASHING BEFORE INSTALLING FIELD FABRICATED PIPE SEAL.
2. TEMPERATURE OF METAL COLLAR MUST NOT EXCEED 180°F (82°C).
3. IN COLDER TEMPERATURES, A HEAT GUN MUST BE USED WHEN FORMING QUICK-APPLIED UNCURED FLASHING.

DIMENSIONS		cm	
(A)	1/2"	1.5	MIN.
(B)	1"	2.5	MIN.
(C)	3"	7.5	MIN.

MAXIMUM WARRANTY: 30 YEARS



FIELD FABRICATED HOT STACK (30 YEAR WARRANTIES)

-  → EPDM MEMBRANE
-  → APPROVED SUBSTRATE
-  → SEE NOTE(S)

VersiGard COMMON DETAILS (EPDM)

VGC-8.4A

9A MECHANICAL TERMINATION WITH COUNTER FLASHING

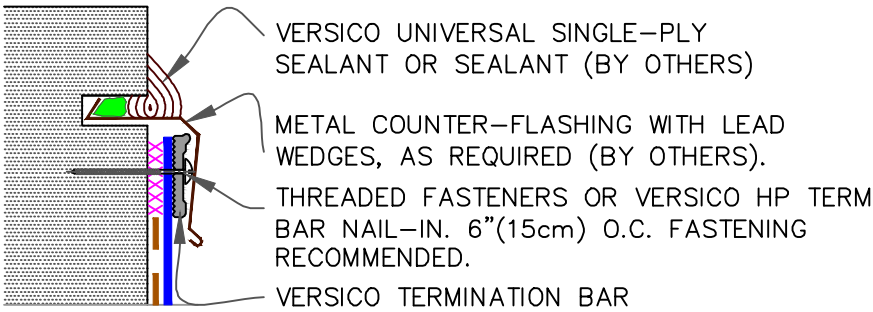

WARRANTY UP TO 30 YEARS SEE INSET A

9B MECHANICAL TERMINATION

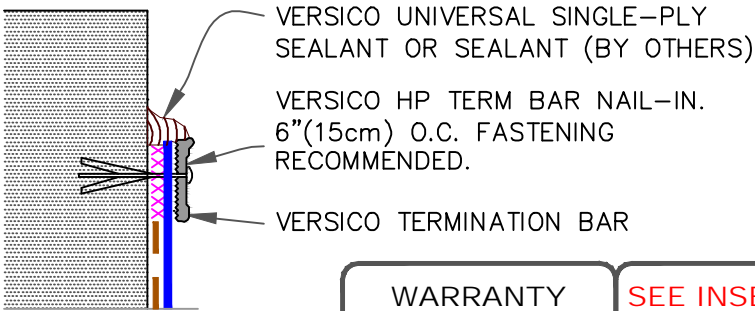

WARRANTY UP TO 20 YEARS SEE INSET A

9C COUNTER FLASHING TERMINATION

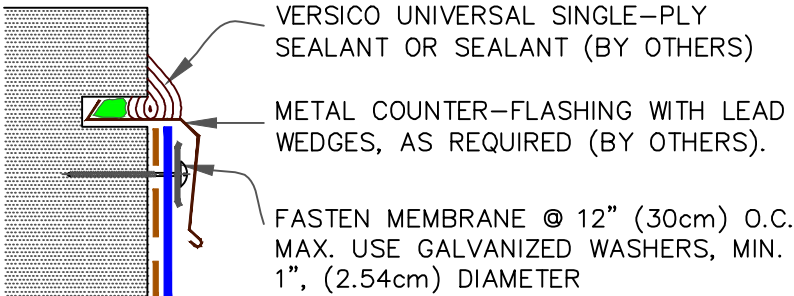

WARRANTY UP TO 10 YEARS

MAXIMUM WARRANTY: AS NOTED

— APPLICABLE BONDING ADHESIVE

xxx WATER CUT-OFF MASTIC— MUST BE HELD UNDER CONSTANT COMPRESSION.

INSET A

CORNER

NOTES:

1. APPLY ON HARD SMOOTH SURFACE ONLY; NOT FOR USE ON EXPOSED WOOD.
2. DO NOT WRAP TERMINATION BAR AROUND CORNERS.
3. DETAIL [9D NEXT PAGE](#) MUST BE USED AT VERTICAL JOINTS IN PANEL WALLS.



MEMBRANE TERMINATION (PAGE 1 OF 3)

→ EPDM MEMBRANE
 → APPROVED SUBSTRATE
 0 → SEE NOTE(S)

VersiGard COMMON DETAILS (EPDM)
 VGC-9.0A

9D MECHANICAL TERMINATION AT VERTICAL JOINTS

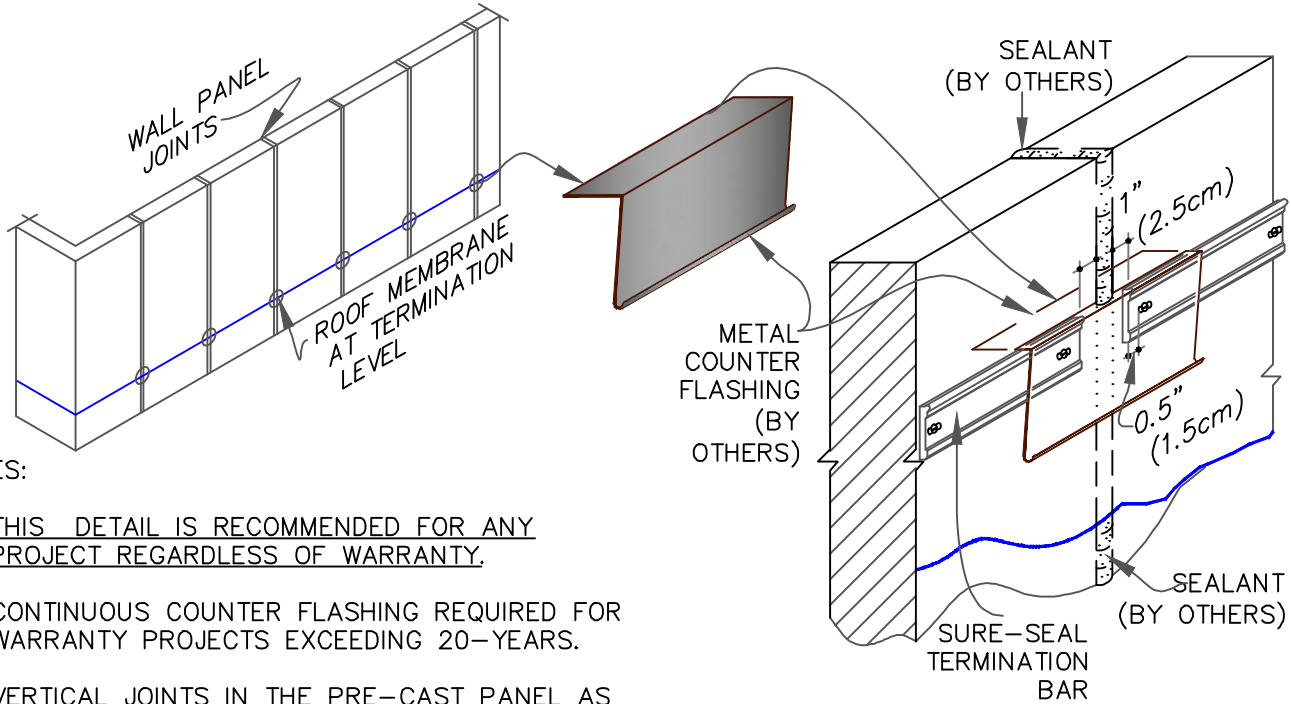

NOTES:

1. THIS DETAIL IS RECOMMENDED FOR ANY PROJECT REGARDLESS OF WARRANTY.
2. CONTINUOUS COUNTER FLASHING REQUIRED FOR WARRANTY PROJECTS EXCEEDING 20-YEARS.
3. VERTICAL JOINTS IN THE PRE-CAST PANEL AS WELL AS ALL GAPS AT THE JUNCTION OF THE TILT-UP PANEL AND ROOF DECK MUST BE FULLY SEALED TO PREVENT AIR INFILTRATION.
4. APPLY ON HARD SMOOTH SURFACE ONLY.

9E VERSITRIM & VERSITRIM 300 COPINGS

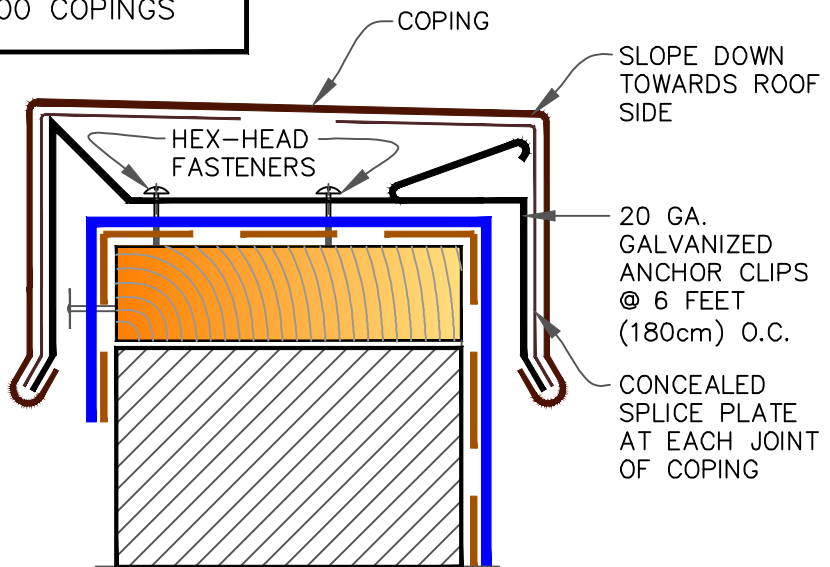

NOTES:

1. MEMBRANE MUST BE EXTENDED AT CORNERS TO PROVIDE COMPLETE COVERAGE OF THE TOP WALL SURFACE. SEE [3D DETAIL 9F](#) ON [PAGE 3 OF 3](#).
2. REFER TO [VERSITRIM COPING INSTALLATION INSTRUCTION MANUAL](#) FOR STEP-BY-STEP INSTRUCTION PROCEDURES AND WARRANTY.

MAXIMUM WARRANTY: 30 YEARS

— — — — — APPLICABLE BONDING ADHESIVE



MEMBRANE TERMINATION
(PAGE 2 OF 3)

— → EPDM MEMBRANE
 → APPROVED SUBSTRATE
0 → SEE NOTE(S)

VersiGard COMMON DETAILS (EPDM)

VGC-9.0B

9F SHEET METAL COPING (BY OTHERS)

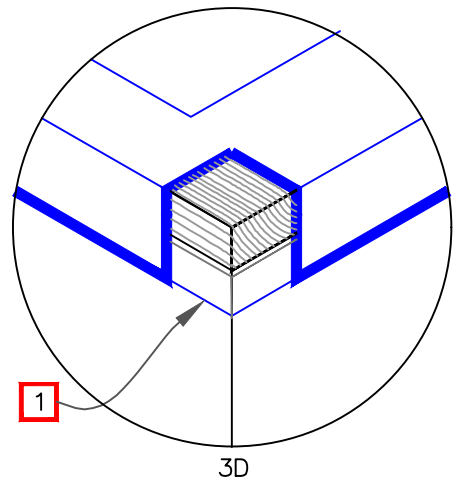
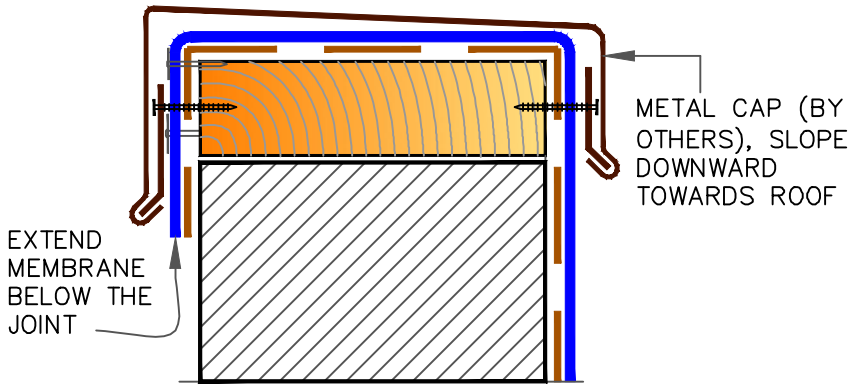

NOTES:

1. MEMBRANE MUST BE EXTENDED TO CORNERS TO PROVIDE COMPLETE COVERAGE OF THE TOP WALL SURFACE.
2. WARRANTY AS PROVIDED (BY OTHERS)

9G MASONRY COPINGS (BY OTHERS)

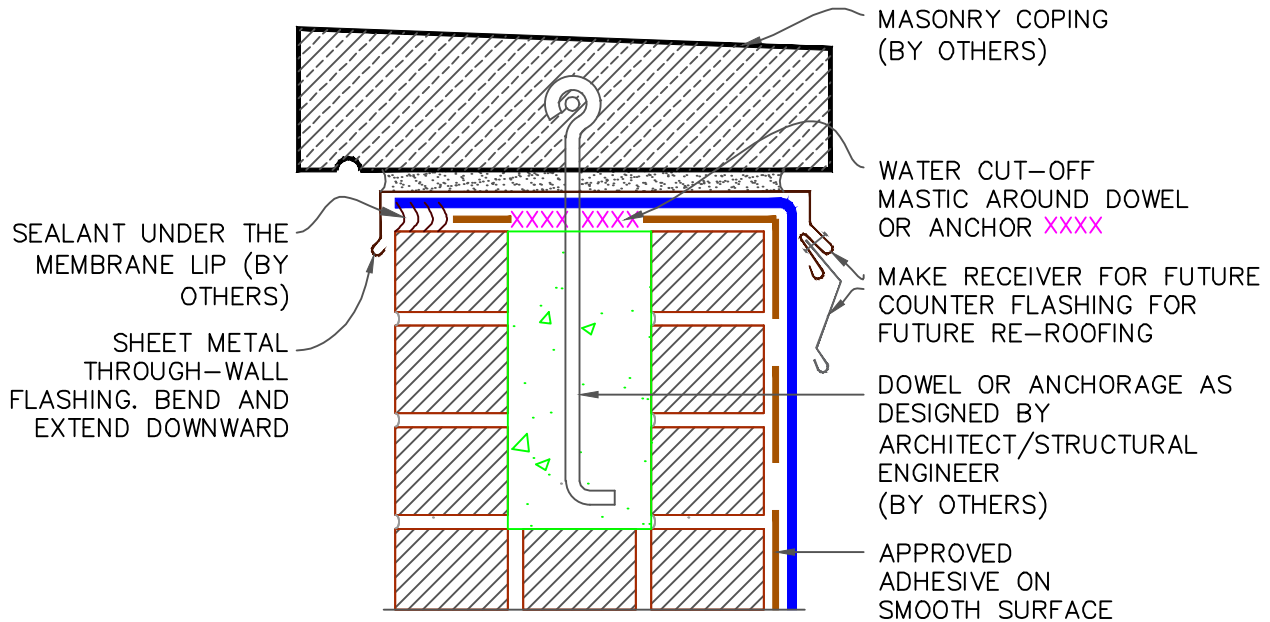

MAXIMUM WARRANTY: 30 YEARS



— — — — — APPLICABLE BONDING ADHESIVE

xxx WATER CUT-OFF MASTIC— MUST BE HELD UNDER CONSTANT COMPRESSION.

MAXIMUM WARRANTY: 30 YEARS



MEMBRANE TERMINATION (PAGE 3 OF 3)

-  → EPDM MEMBRANE
-  → APPROVED SUBSTRATE
-  → SEE NOTE(S)

VersiGard COMMON DETAILS (EPDM)

VGC-9.0C

NOTES:

1. FASTENERS AND PLATES ARE REQUIRED AT 6" (15cm) O.C. FOR ADHERED SYSTEMS WITH WARRANTY WIND SPEED COVERAGE GREATER THAN 90 MPH AND FOR ALL PROJECTS WITH WARRANTIES GREATER THAN 20 YEARS. HPV FASTENERS AND POLYMER SEAM PLATES ARE REQUIRED OVER STEEL DECKS ON MECHANICALLY ATTACHED SYSTEMS.
2. PROJECTS WITH 25 AND 30-YEAR WARRANTIES OR WHEN USING 90-MIL MEMBRANE, REFER TO DETAIL VGC-2.3.
3. FOR CORNERS AND RTS APPLICATION REFER TO DETAILS VGC-15.1 OR VGC-15.2.

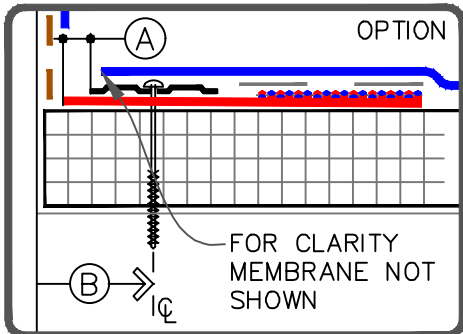
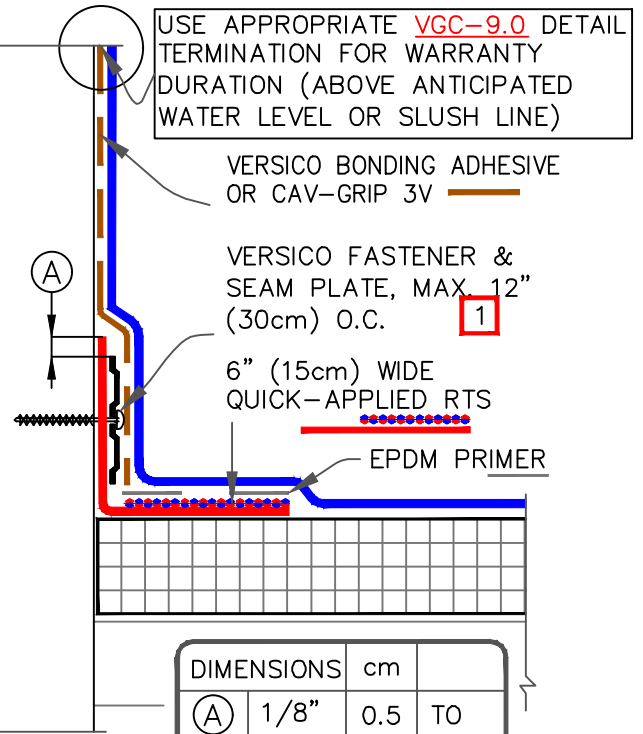

DIMENSIONS		cm	
(A)	1/8"	0.5	TO
	1"	2.5	MAX.
(B)	6"	15	MAX.

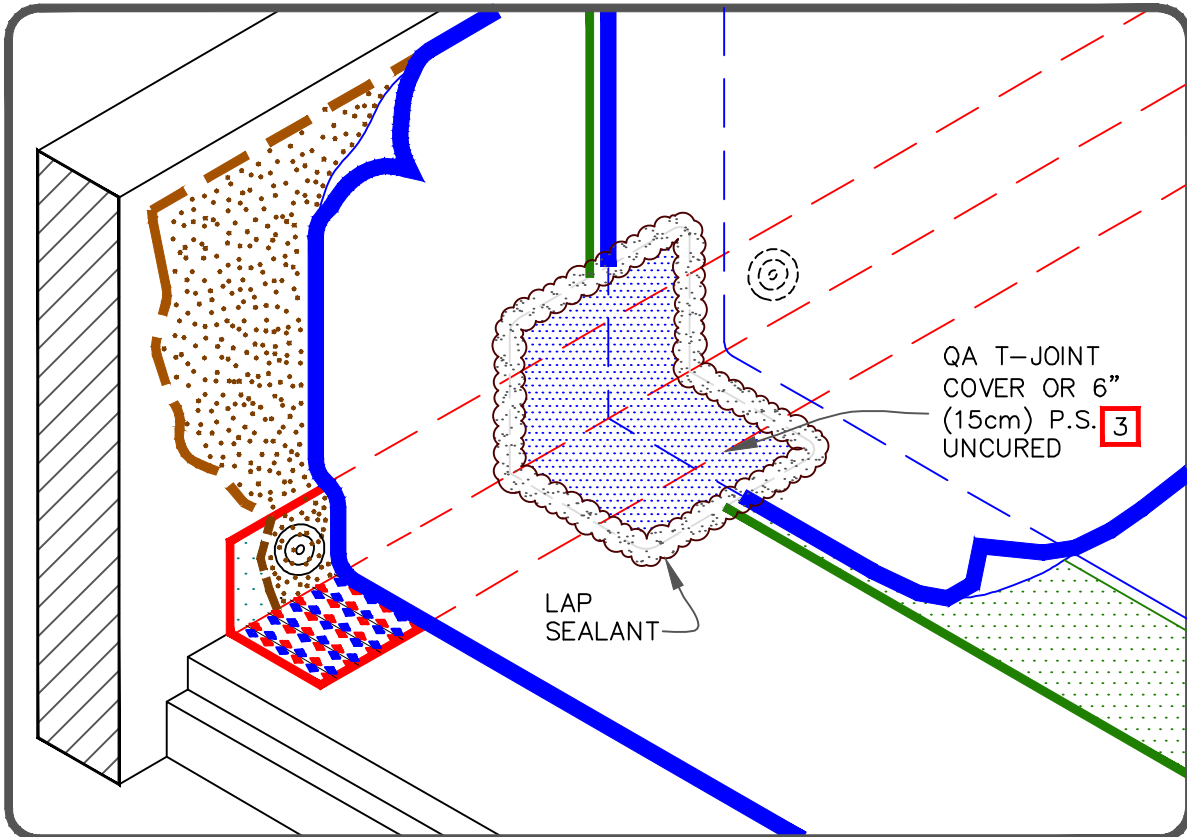

QA (QUICK APPLIED)

MAXIMUM WARRANTY: 30 YEARS



PARAPET / CURB WITH CONTINUOUS MEMBRANE

- EPDM MEMBRANE
- APPROVED SUBSTRATE
- SEE NOTE(S)

VersiGard COMMON DETAILS (EPDM)

VGC-12.1

NOTES:

1. FASTENERS AND PLATES ARE REQUIRED AT 6" (15cm) O.C. FOR ADHERED SYSTEMS WITH WARRANTY WIND SPEED COVERAGE GREATER THAN 90 MPH AND FOR ALL PROJECTS WITH WARRANTIES GREATER THAN 20 YEARS. HPV FASTENERS AND POLYMER SEAM PLATES ARE REQUIRED OVER STEEL DECKS ON MECHANICALLY ATTACHED SYSTEMS.
2. USE 6" (15cm) WIDE QA SEAM TAPE FOR 25/30 YEAR WARRANTIES. LAP SEALANT IS REQUIRED ON CUT EDGES OF REINFORCED MEMBRANE.
3. PROJECTS WITH 25 AND 30-YEAR WARRANTIES OR WHEN USING 90-MIL MEMBRANE, REFER TO [DETAIL VGC-2.3](#).

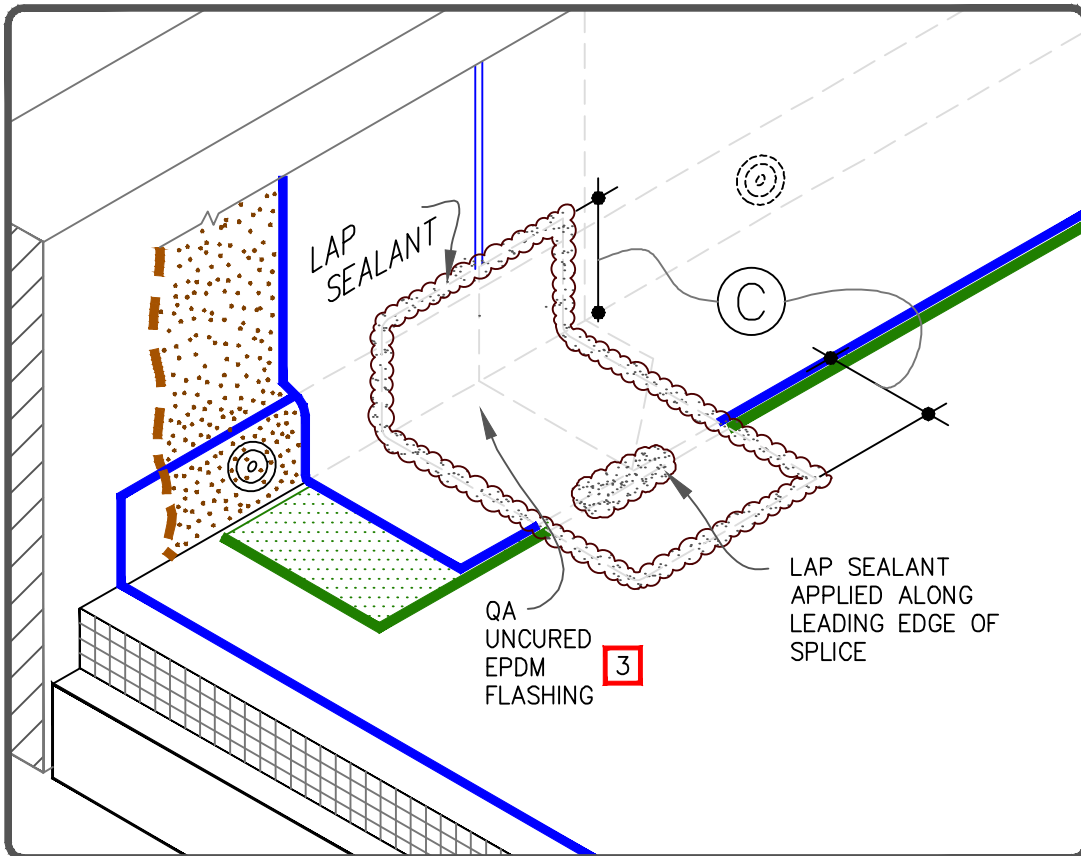
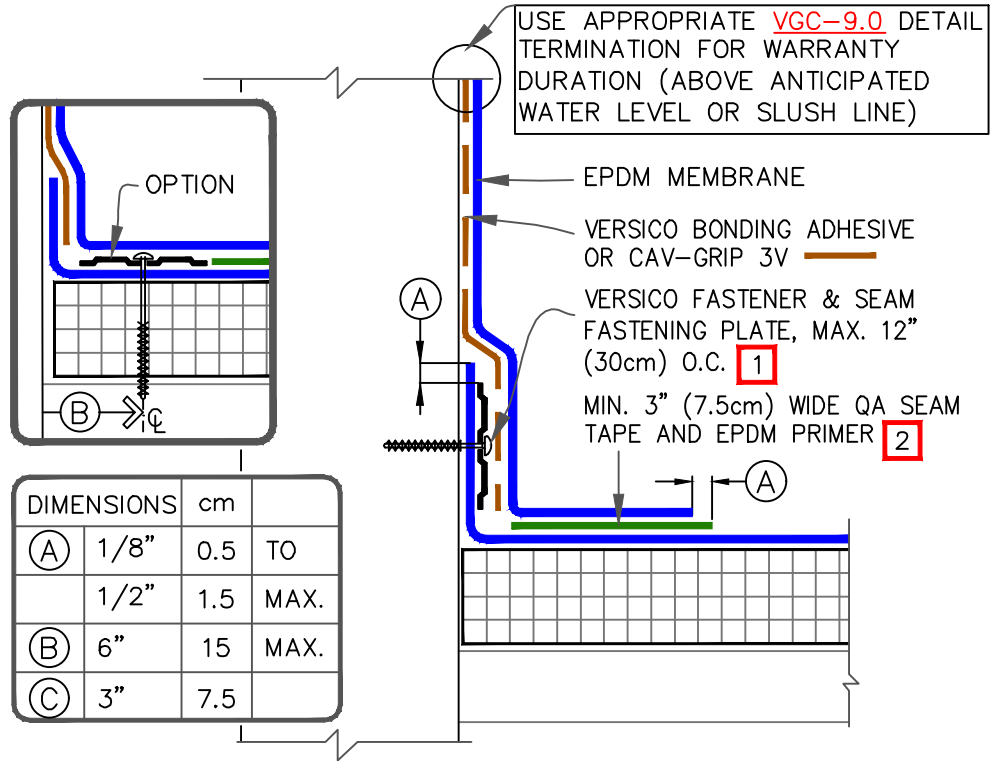

QA (QUICK APPLIED)

MAXIMUM WARRANTY: 30 YEARS



PARAPET / CURB WITH SEPARATE MEMBRANE FLASHING

- █ → EPDM MEMBRANE
- APPROVED SUBSTRATE
- 0 → SEE NOTE(S)

VersiGard COMMON DETAILS (EPDM)

VGC-12.2

USE APPROPRIATE [VGC-9.0](#) DETAIL TERMINATION FOR WARRANTY DURATION (ABOVE ANTICIPATED WATER LEVEL OR SLUSH LINE)

PRIME THE WALL WITH CAV-GRIP 3V OR EPDM BONDING ADHESIVE. (DO NOT APPLY ON BACK OF MEMBRANE)

VERSICO FASTENER & SEAM PLATE, MAX. 12" (30cm) 2 O.C.

6" (15cm) WIDE QUICK-APPLIED RTS

QA EPDM MEMBRANE

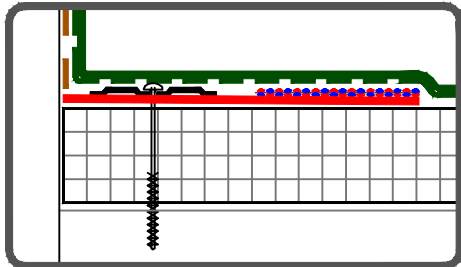

OPTIONAL: SEAM PLATE/FASTENER MAY BE INSTALLED INTO THE STRUCTURAL DECK UP TO 6" (15cm) FROM ANGLE CHANGE.

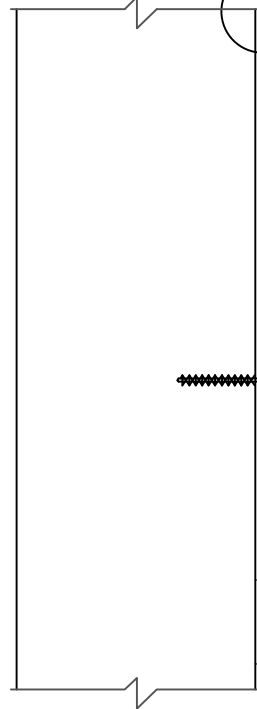

NOTES:

1. FOR CORNERS AND RTS APPLICATION, REFER TO DETAILS [VGC-15.1](#) OR [VGC-15.2](#).
2. FASTENERS AND PLATES REQUIRED AT 6" (7.5cm) O.C. FOR WARRANTY WIND SPEEDS EXCEEDING 90 MPH.

CAV-GRIP 3V OR VERSIGARD BONDING ADHESIVE

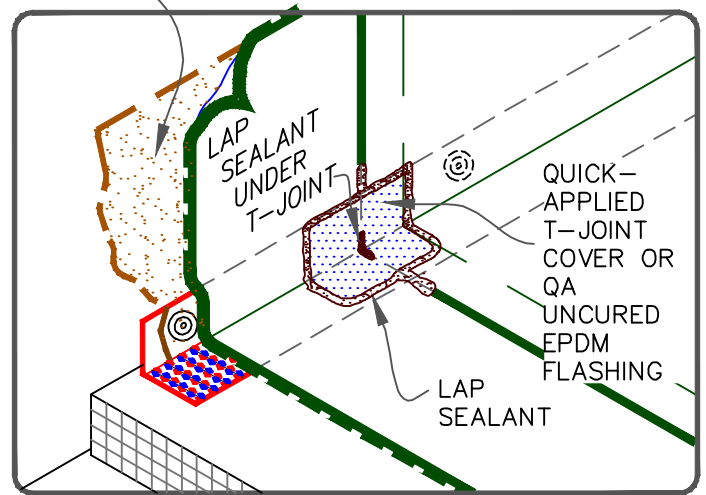

MAXIMUM WARRANTY: 20 YEARS



PARAPET / CURB WITH QUICK-APPLIED RTS (VERTICAL)

→ EPDM MEMBRANE
 → APPROVED SUBSTRATE
0 → SEE NOTE(S)

QUICK APPLIED TECHNOLOGY

VGC-12.3

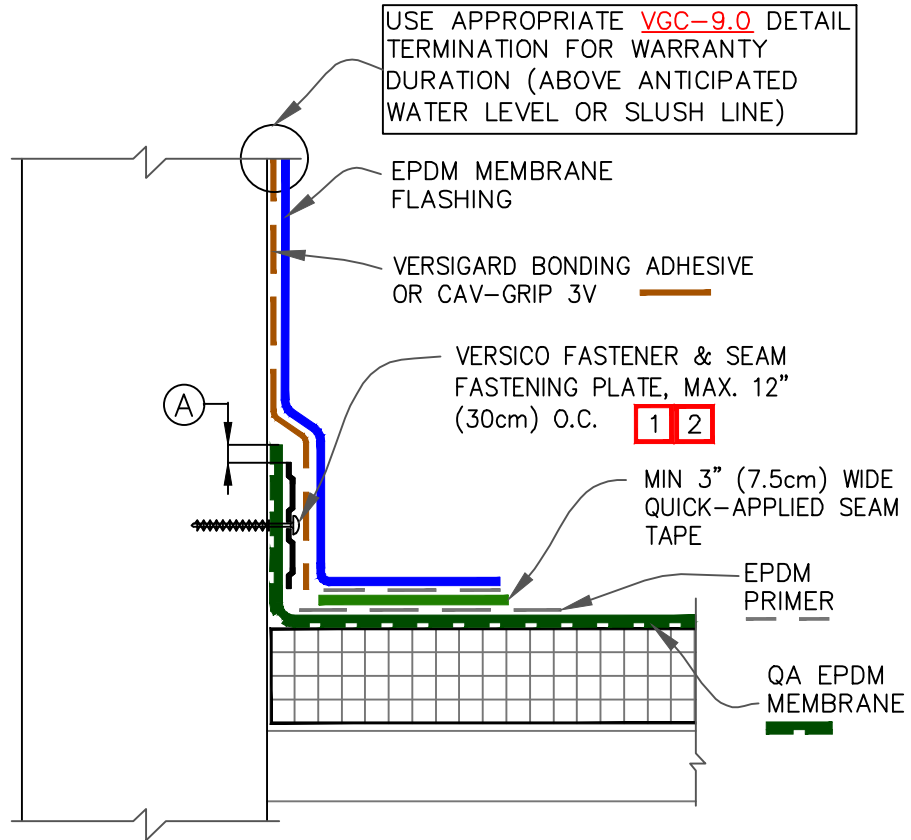

DIMENSION	cm	
(A)	1/8"-1"	0.5-2.5
(B)	3"	7.5

NOTES:

1. SEAM FASTENING PLATE/FASTENER MAY BE INSTALLED INTO THE STRUCTURAL DECK ALSO.
2. FASTENERS AND PLATES REQUIRED AT 6" (7.5cm) O.C. FOR WARRANTY WIND SPEEDS EXCEEDING 90 MPH.
3. APPLY QUICK-APPLIED UNCURED EPDM FLASHING COVERING VERTICAL SPLICE INTERSECTIONS.

VERSIGARD BONDING ADHESIVE OR CAV-GRIP 3V

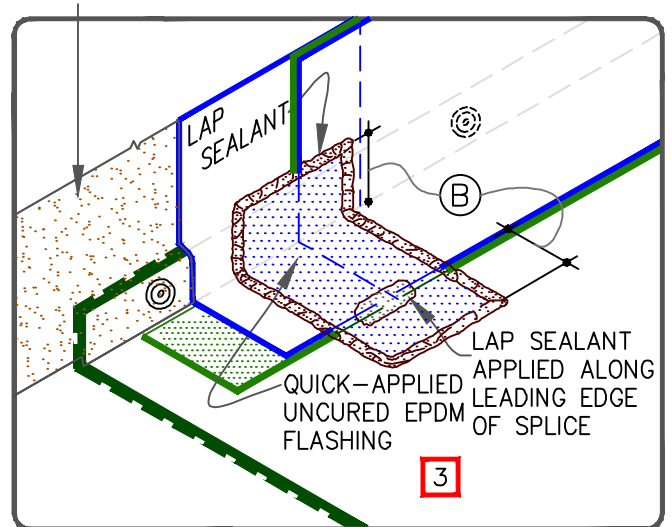

MAXIMUM WARRANTY: 20 YEARS



PARAPET/CURB FLASHING WITH SEPARATE REGULAR EPDM FLASHING

→ EPDM MEMBRANE

→ APPROVED SUBSTRATE

0 → SEE NOTE(S)

QUICK APPLIED TECHNOLOGY

VGC-12.4

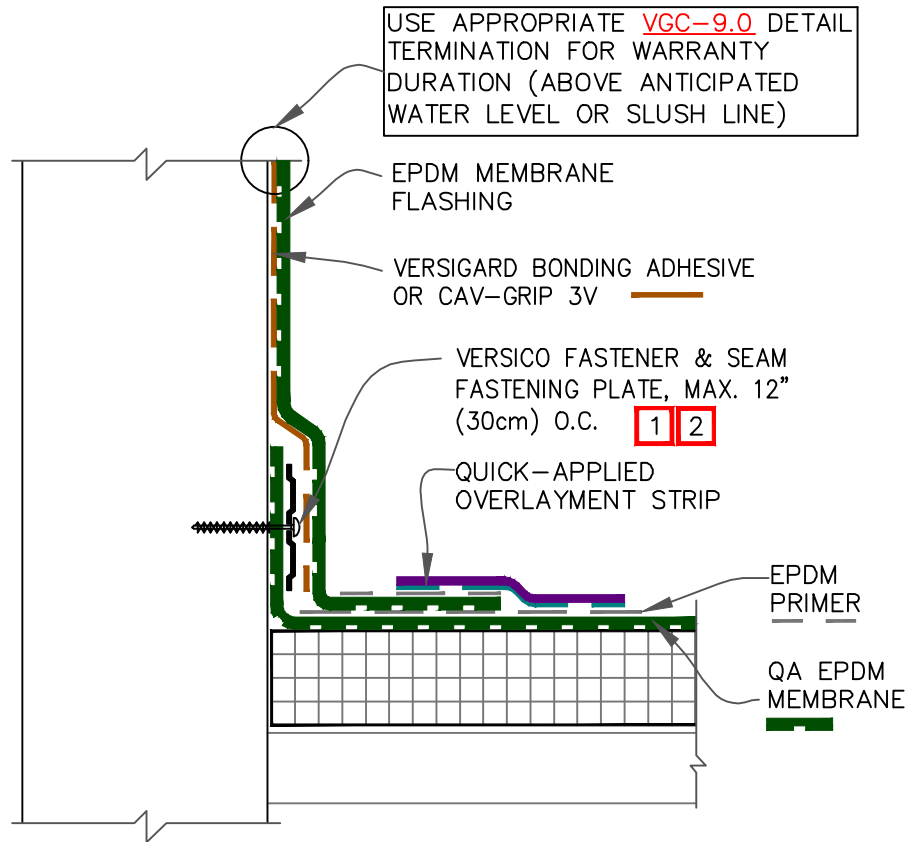

VERSIGARD BONDING ADHESIVE OR CAV-GRIP 3V

DIMENSIONS		cm
(A)	3"	7.5

NOTES:

1. SEAM FASTENING PLATE/FASTENER MAY BE INSTALLED INTO THE STRUCTURAL DECK ALSO.
2. FASTENERS AND PLATES REQUIRED AT 6" (7.5cm) O.C. FOR WARRANTY WIND SPEEDS EXCEEDING 90 MPH.
3. APPLY QUICK-APPLIED UNCURED EPDM FLASHING COVERING VERTICAL SPLICE INTERSECTIONS.

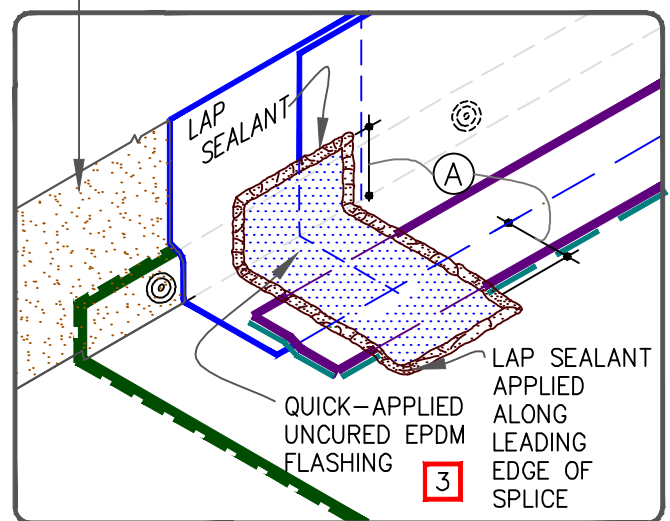

MAXIMUM WARRANTY: 20 YEARS



PARAPET/CURB WITH SEPARATE QA EPDM

█ → EPDM MEMBRANE
0 → SEE NOTE(S)
0 → APPROVED SUBSTRATE

QUICK APPLIED TECHNOLOGY

VGC-12.5

USE APPROPRIATE **VGC-9.0** DETAIL TERMINATION FOR WARRANTY DURATION (ABOVE ANTICIPATED WATER LEVEL OR SLUSH LINE)

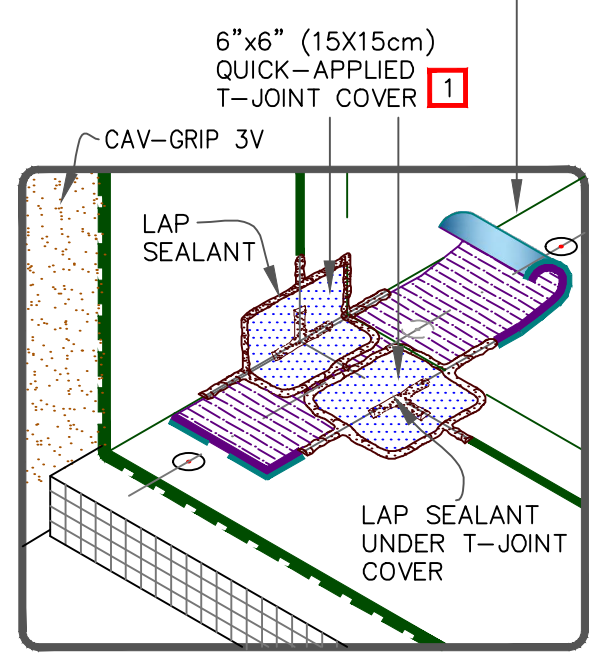
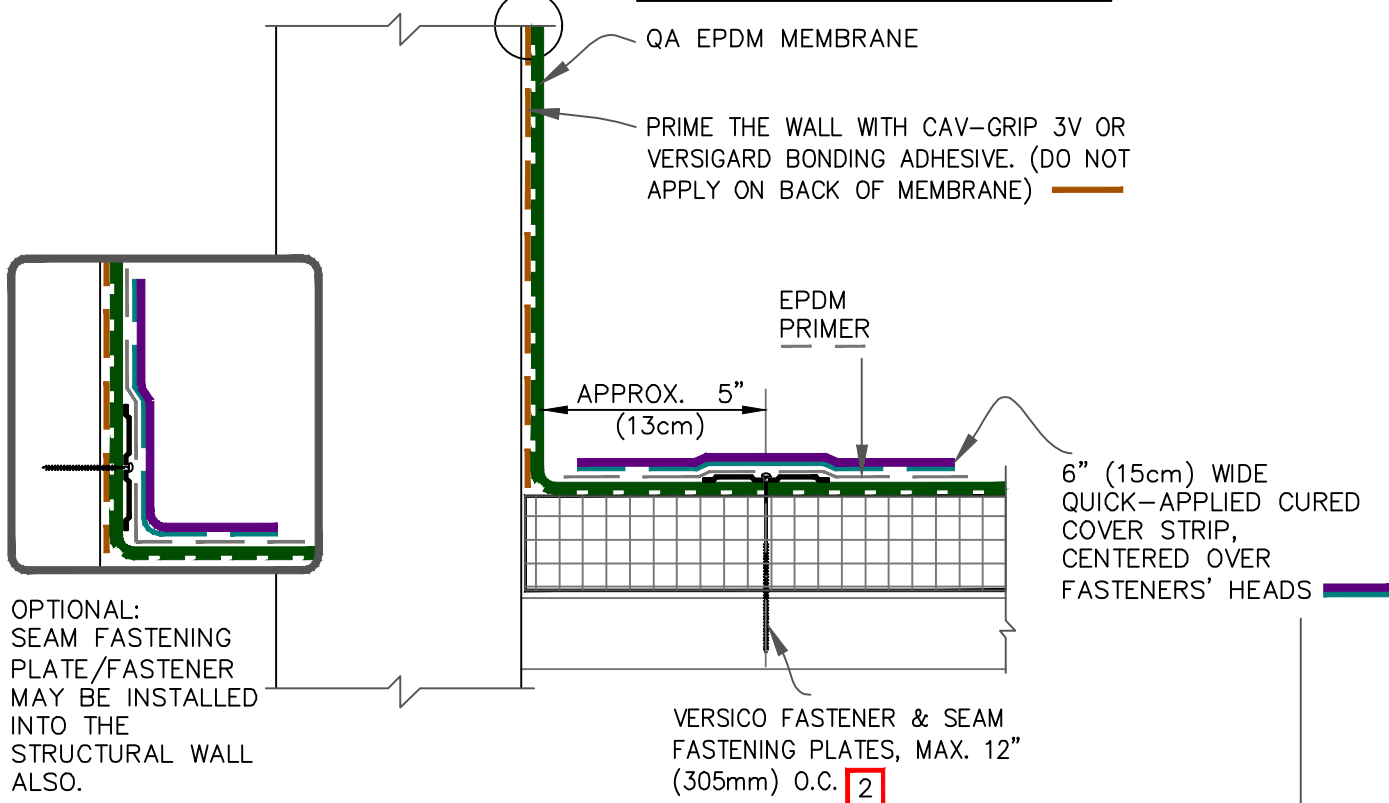

NOTES:

1. T-JOINTS CAN BE ELIMINATED WHEN QUICK-APPLIED OVERLAYMENT STRIP IS USED.
2. FASTENERS AND PLATES REQUIRED AT 6" (7.52cm) O.C. FOR WARRANTY WIND SPEEDS EXCEEDING 90 MPH.

MAXIMUM WARRANTY: 20 YEARS



PARAPET/CURB FLASHING

QUICK APPLIED TECHNOLOGY

VGC-12.6

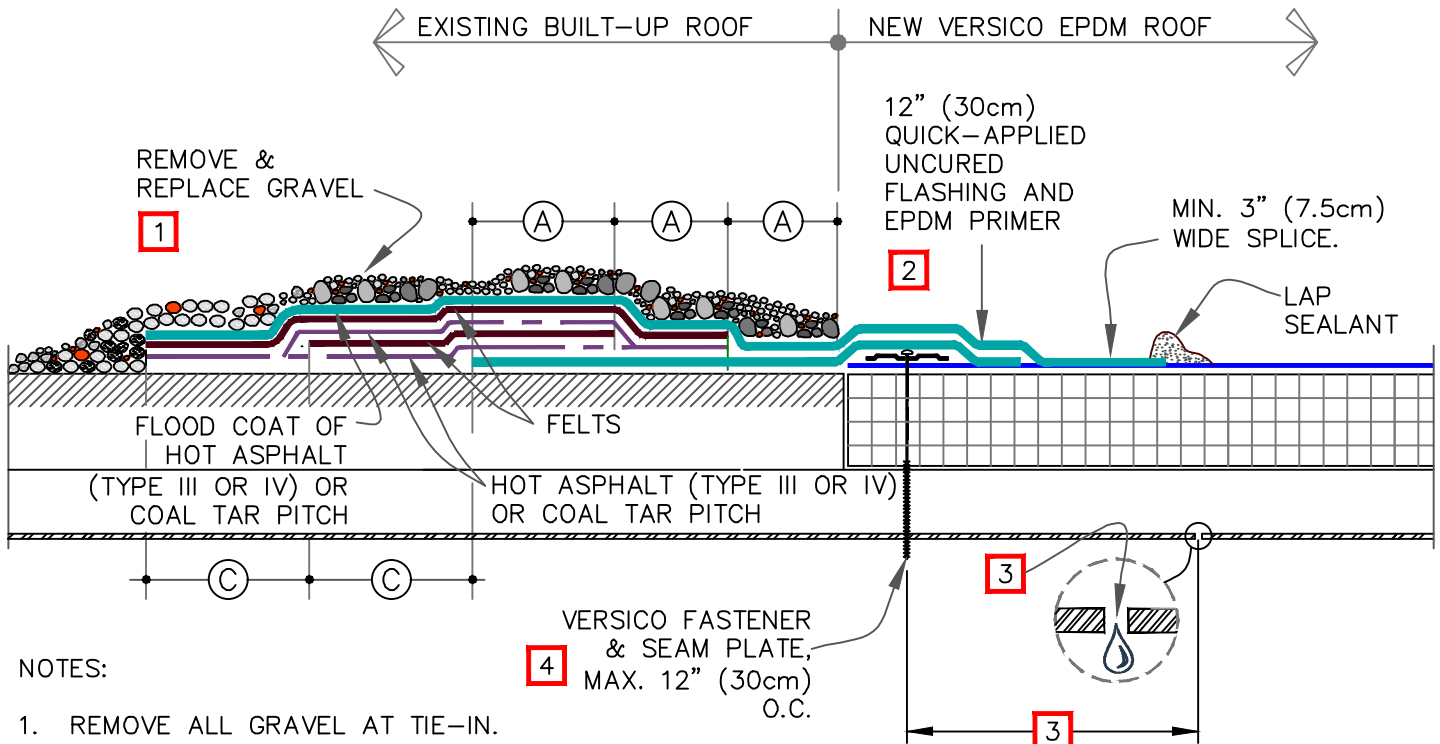

NOTES:

1. REMOVE ALL GRAVEL AT TIE-IN.
2. SPLICE TWO PIECES OF UNCURED EPDM OR QUICK-APPLIED UNCURED EPDM TOGETHER TO ACHIEVE DESIRED WIDTH.
3. IF FLUTES ARE PERPENDICULAR TO THE TIE-IN DRILL A 3/8" (1cm) DIAMETER WEEP HOLE ON THE BOTTOM FLUTES OF THE STEEL DECK ALONG THE PERIMETER TO THE TIE-IN 6" (15cm) FROM THE SEAM FASTENING PLATE.
4. ON MECHANICALLY ATTACHED SYSTEMS, HPV FASTENERS AND POLYMER SEAM PLATES ARE REQUIRED OVER STEEL DECKS.
5. IF WATER PONDS OR FLOWS OVER TIE-IN FROM BUR SURFACE, USE [DETAIL VGC-13.2](#).
6. ON BALLASTED SYSTEMS, USE CONCRETE PAVERS TO PREVENT BALLAST MIGRATION.

DIMENSIONS	cm	
(A)	5"	13 MIN.
(B)	2"	± 1/2" (1.5cm)
(C)	6"	15

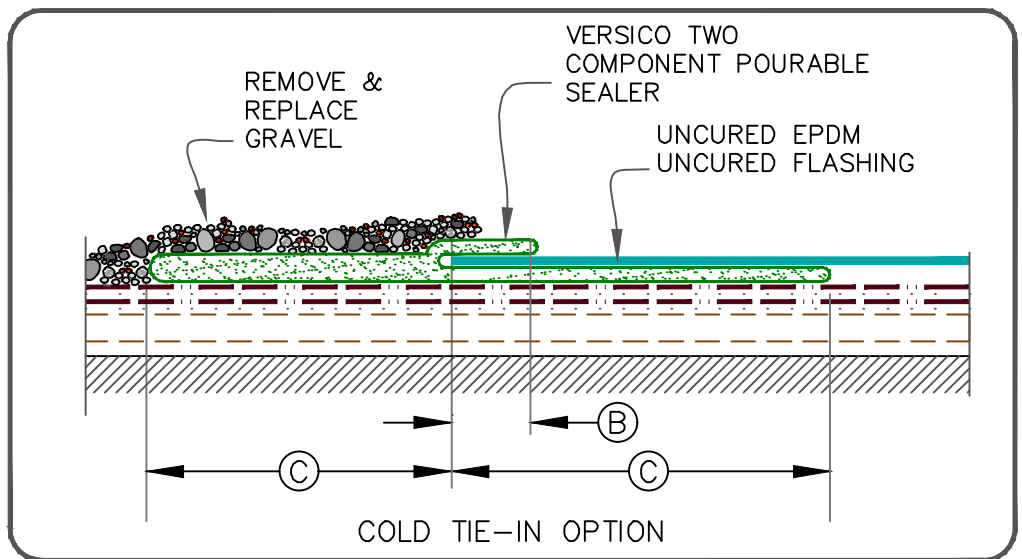

MAXIMUM WARRANTY: 30 YEARS



BUILT-UP ROOFING TIE-IN OVER STEEL ROOF DECK

→ EPDM MEMBRANE

→ APPROVED SUBSTRATE

→ SEE NOTE(S)

VersiGard COMMON DETAILS (EPDM)

VGC-13.1

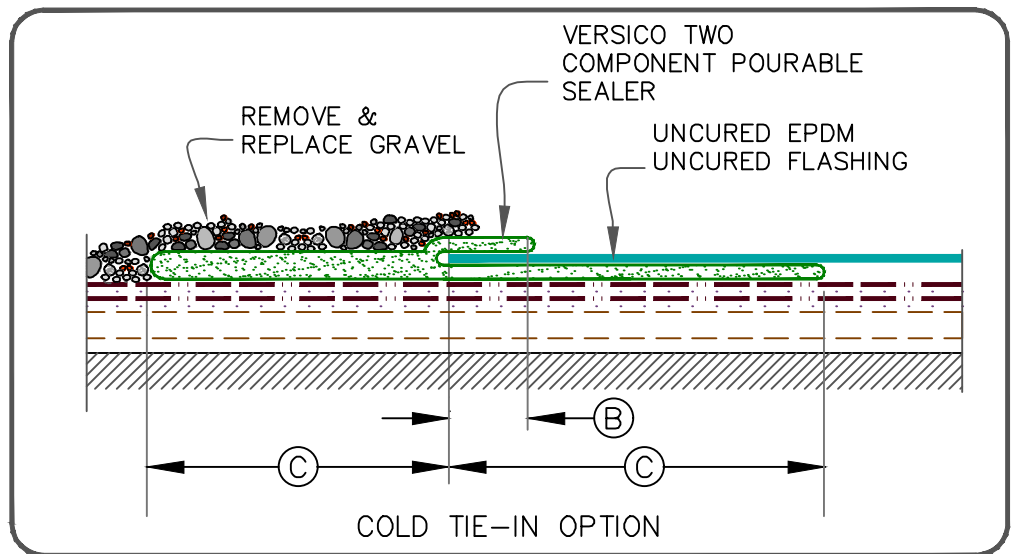
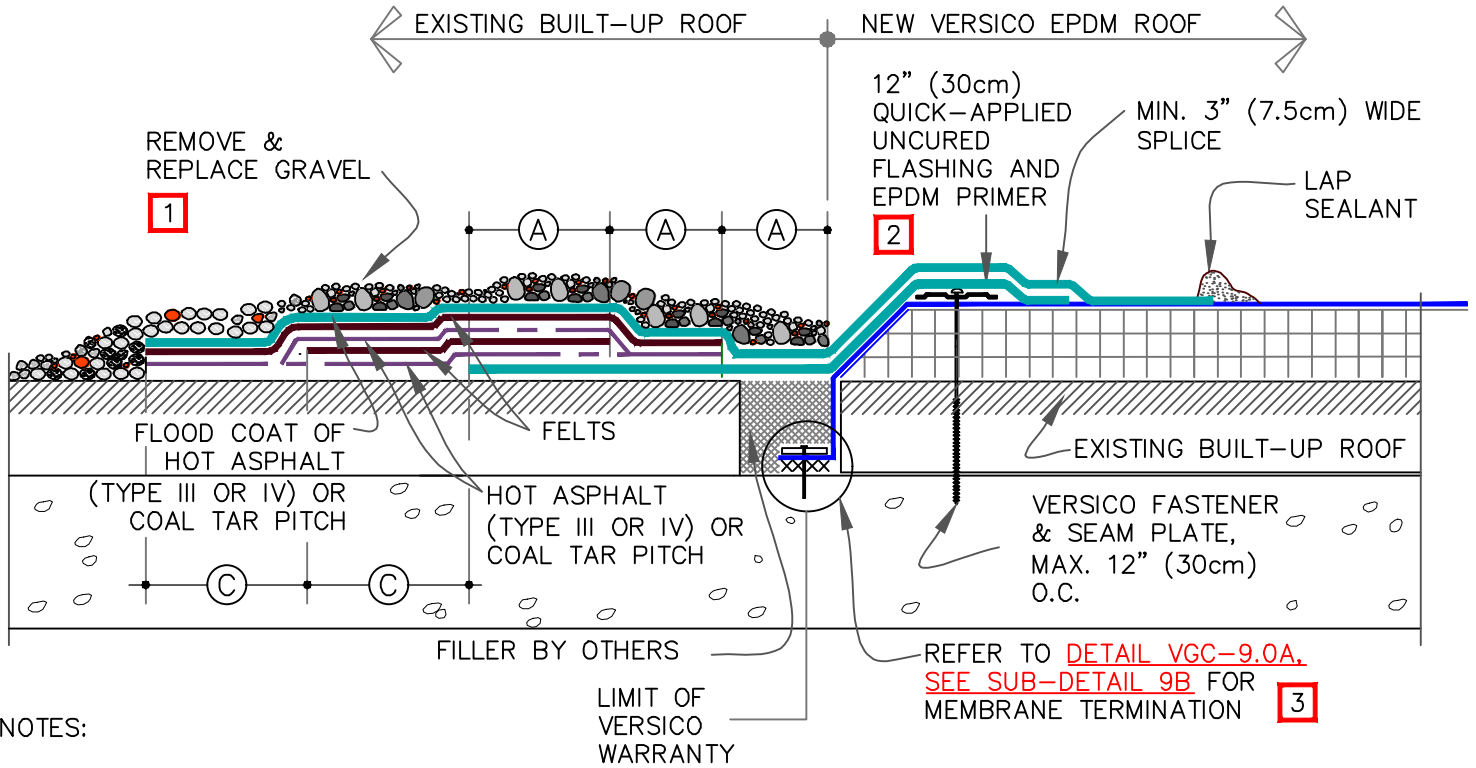

DIMENSIONS		cm	
(A)	5"	13	MIN.
(B)	2"	5	± 1/2" (1.5cm)
(C)	6"	15	

MAXIMUM WARRANTY: 30 YEARS



BUILT-UP ROOFING TIE-IN OVER CONCRETE ROOF DECK

- EPDM MEMBRANE
- APPROVED SUBSTRATE
- SEE NOTE(S)

VersiCard COMMON DETAILS (EPDM)

VGC-13.2

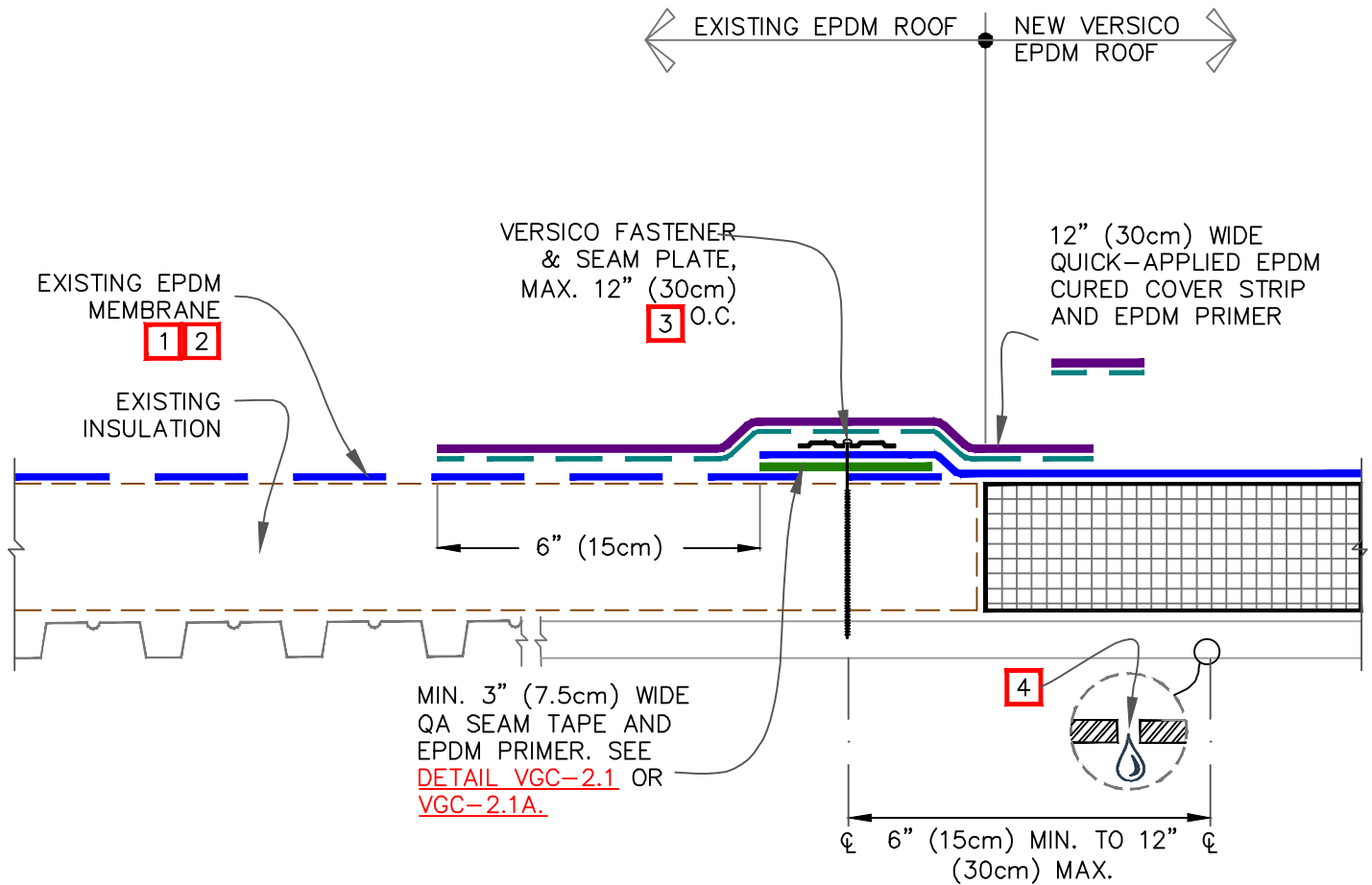



NOTES:

1. CONTACT MANUFACTURER OF EXISTING EPDM MEMBRANE ROOFING SYSTEM TO VERIFY ACCEPTANCE OF TIE-IN AND TO NOT VOID EXISTING WARRANTY.
2. PRIOR TO SPLICING, CLEAN EXISTING EPDM MEMBRANE BY SCRUBBING THE SPLICE AREA WITH WEATHERED MEMBRANE CLEANER AND ALLOW TO DRY.
3. ON MECHANICALLY ATTACHED SYSTEMS, HPV FASTENERS AND POLYMER SEAM PLATES ARE REQUIRED OVER STEEL DECKS.
4. IF FLUTES ARE PERPENDICULAR TO THE TIE-IN DRILL A 3/8" (1cm) DIAMETER WEEP HOLE INTO THE BOTTOM FLUTES OF THE STEEL DECK ALONG THE PERIMETER OF THE TIE-IN 6" (15cm) MINIMUM TO 12" (30cm) MAXIMUM FROM THE SEAM FASTENING PLATE.

MAXIMUM WARRANTY: 30 YEARS



TIE-IN TO EXISTING EPDM MEMBRANE

-  → EPDM MEMBRANE
-  → APPROVED SUBSTRATE
-  → SEE NOTE(S)

VersiGard COMMON DETAILS (EPDM)

VGC-13.3

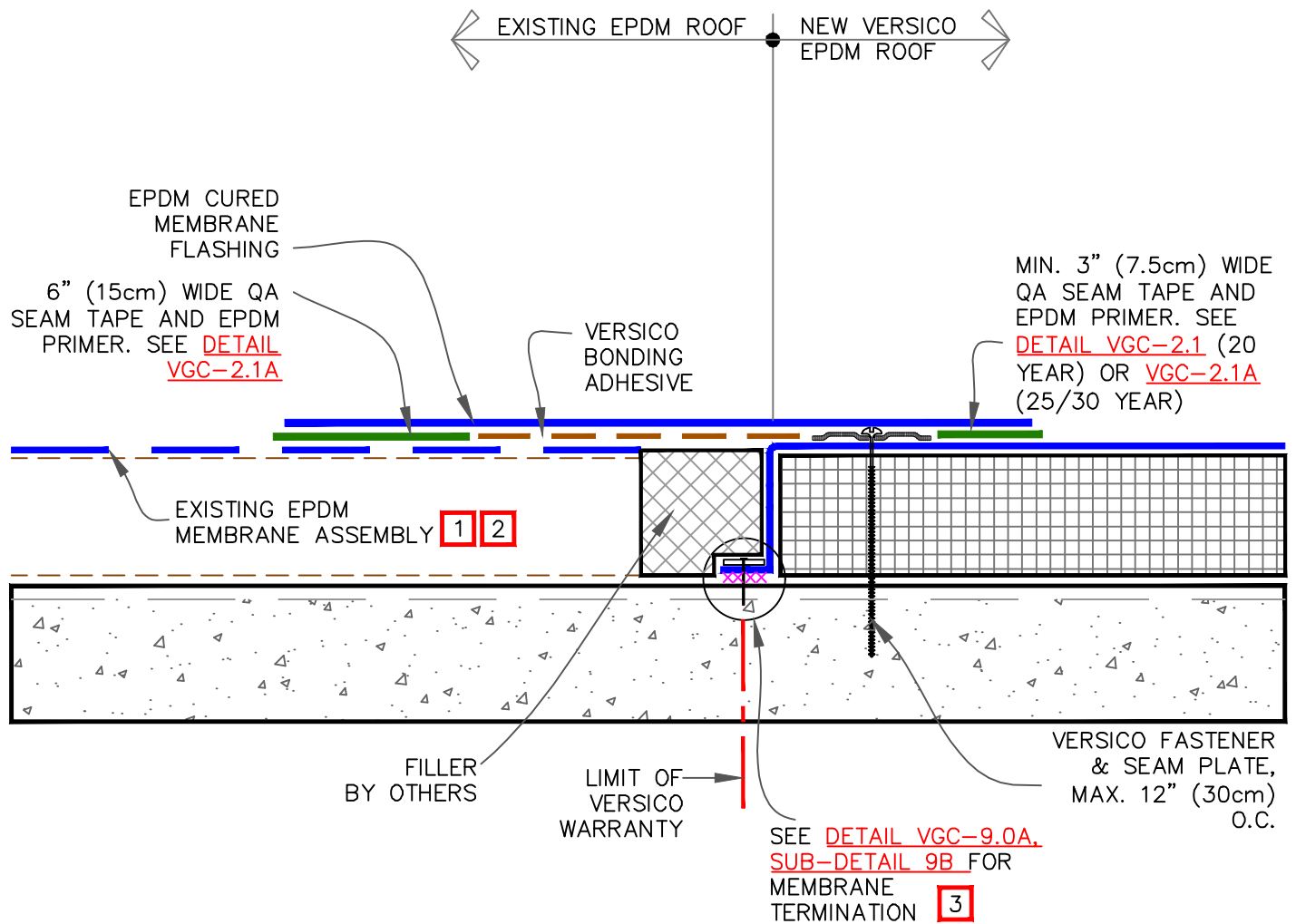

NOTES:

1. CONTACT MANUFACTURER OF EXISTING EPDM MEMBRANE ROOFING SYSTEM TO VERIFY ACCEPTANCE OF TIE-IN AND TO NOT VOID EXISTING WARRANTY.
2. PRIOR TO SPLICING, CLEAN EXISTING EPDM MEMBRANE BY SCRUBBING THE SPLICE AREA WITH WEATHERED MEMBRANE CLEANER; ALLOW TO DRY.
3. WATER CUT-OFF MASTIC MUST BE HELD UNDER CONSTANT COMPRESSION. WHEN RE-ROOFING OVER PRE-CAST CONCRETE, APPLY LIBERAL BEAD OF WATER CUT-OFF MASTIC IN THE JOINTS TO PREVENT MOISTURE MIGRATION.

MAXIMUM WARRANTY: 30 YEARS



EPDM TIE-IN OVER CONCRETE DECK

- EPDM MEMBRANE
- APPROVED SUBSTRATE
- 0 → SEE NOTE(S)

VersiGard COMMON DETAILS (EPDM)

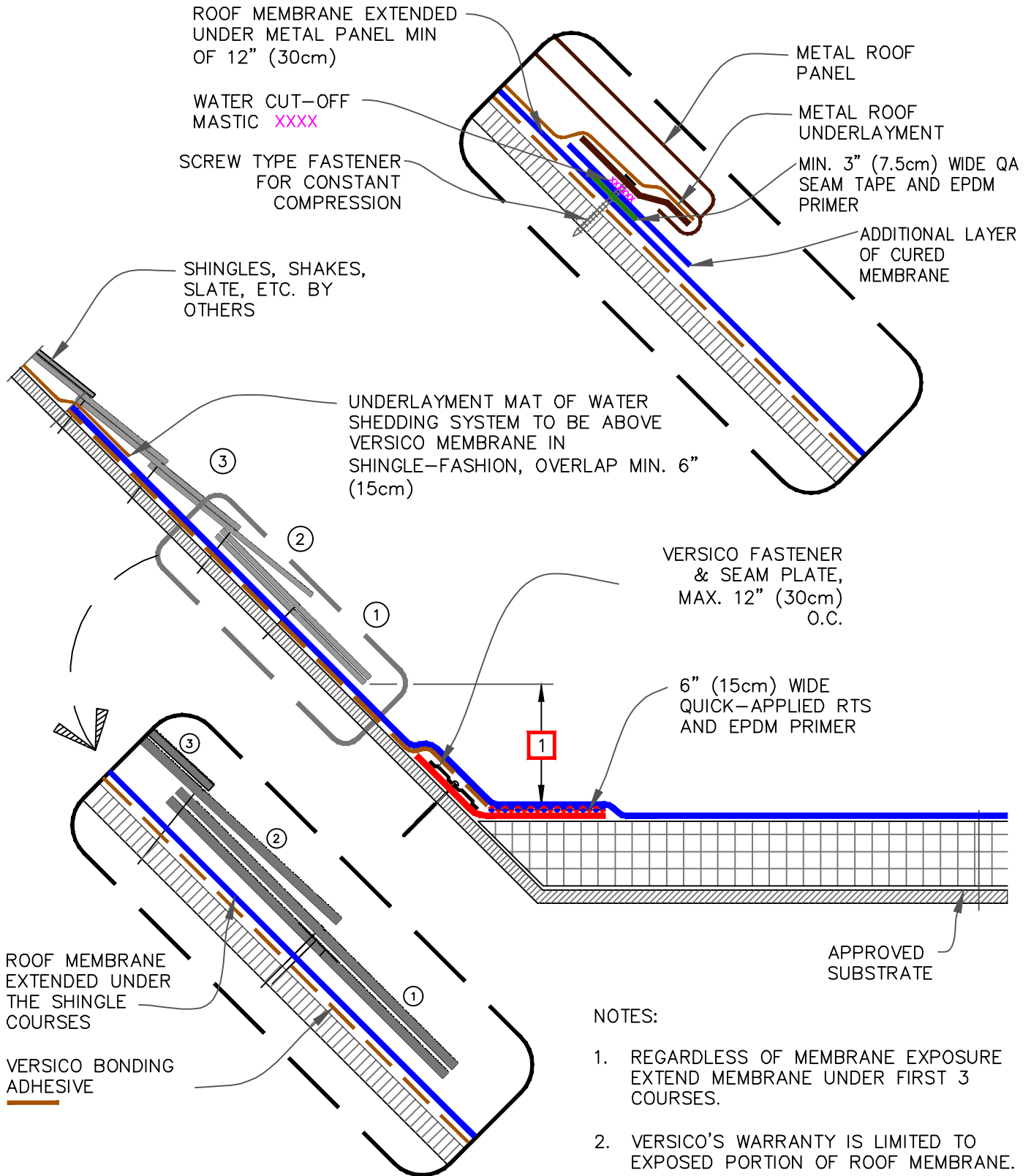

VGC-13.4



MAXIMUM WARRANTY: 30 YEARS



TIE-IN SHINGLED OR METAL PANEL ROOF

-  → EPDM MEMBRANE
-  → APPROVED SUBSTRATE
-  → SEE NOTE(S)

VersiGard COMMON DETAILS (EPDM)

VGC-13.5

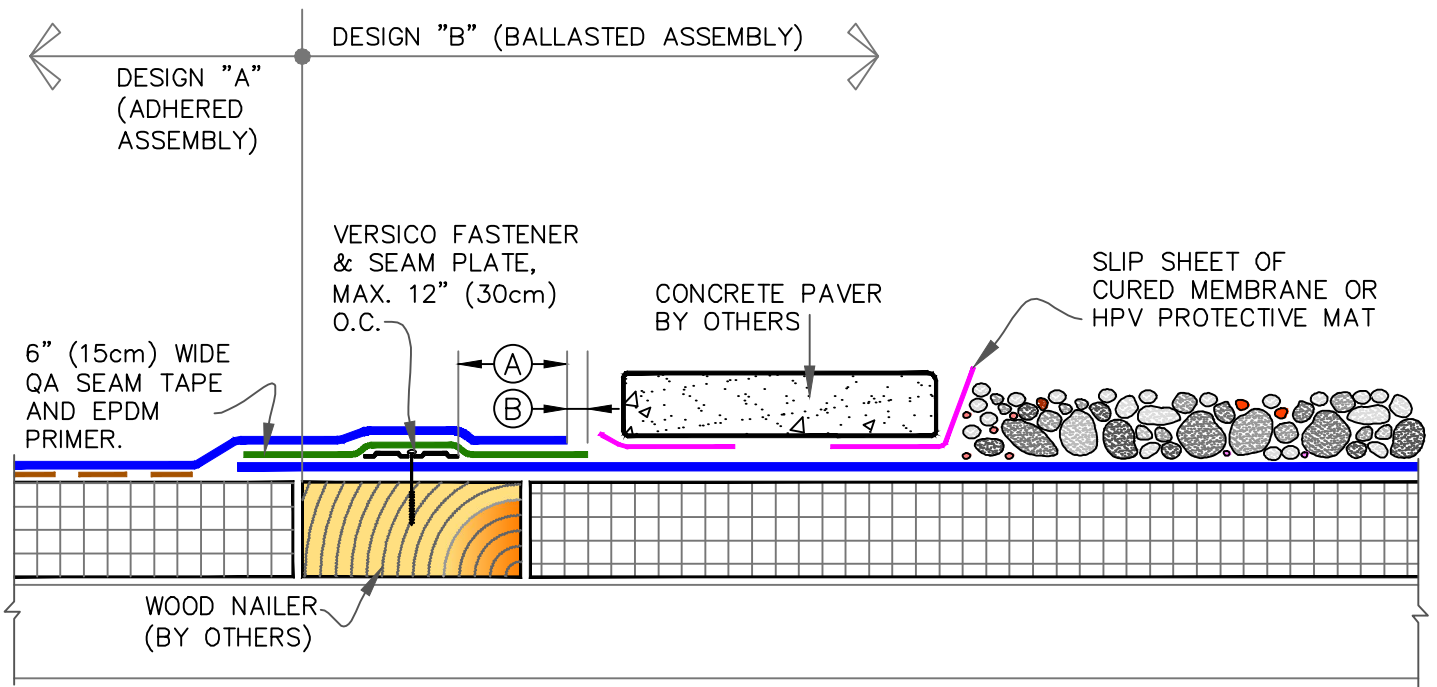

1 BALLASTED TO ADHERED TIE-IN

NOTE:

- ON MECHANICALLY ATTACHED SYSTEMS, HPV FASTENERS AND POLYMER SEAM PLATES ARE REQUIRED OVER STEEL DECKS.

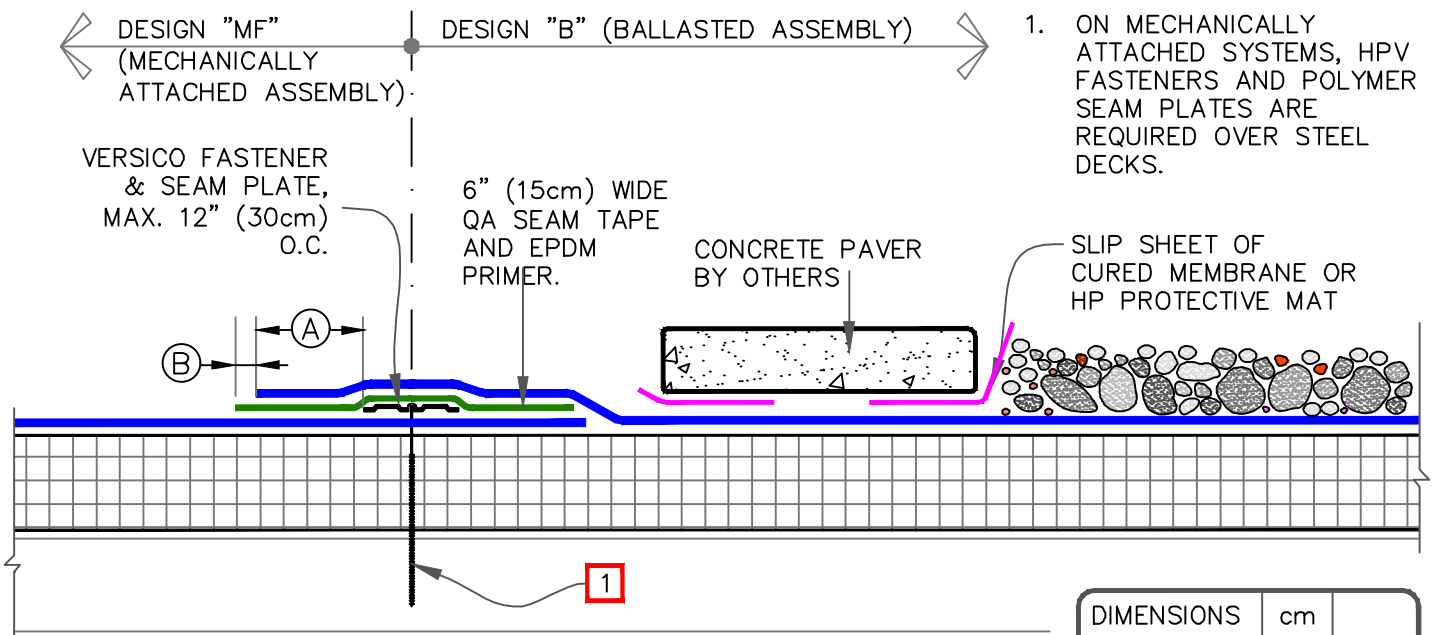

2 BALLASTED TO MECHANICALLY ATTACHED TIE-IN

DIMENSIONS		cm	
(A)	2"	5	MIN.
(B)	1/8"	0.5	MIN.
	1/2"	1.5	MAX.

MAXIMUM WARRANTY: 30 YEARS



TIE-IN BALLASTED ROOF TO ADHERED AND MECHANICALLY ATTACHED

- █ → EPDM MEMBRANE
- APPROVED SUBSTRATE
- 0 → SEE NOTE(S)

VersiCard COMMON DETAILS (EPDM)

VGC-13.6

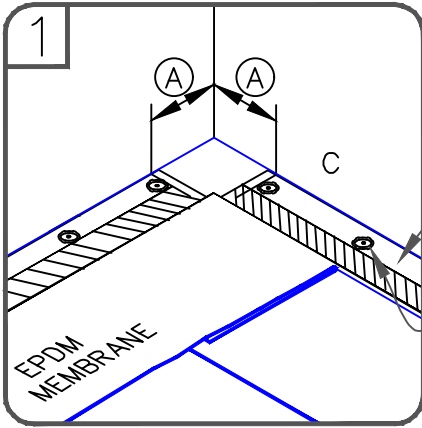

6" (15cm) WIDE QUICK-APPLIED RTS (MAY BE FASTENED INTO VERTICAL SUBSTRATE)

VERSICO SEAM PLATE & FASTENER.

EPDM PRIMER

CUT 45° AND APPLY EPDM PRIMER/QA SEAM TAPE

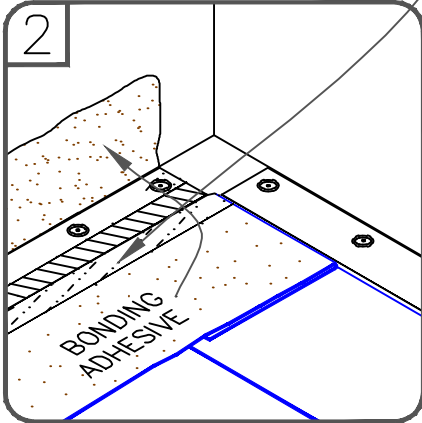
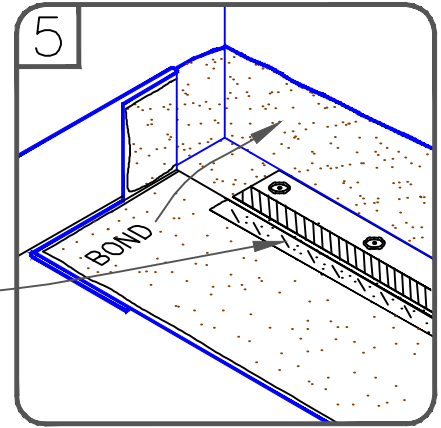

DIMENSIONS		cm	
(A)	6"	15	TO
	9"	23	

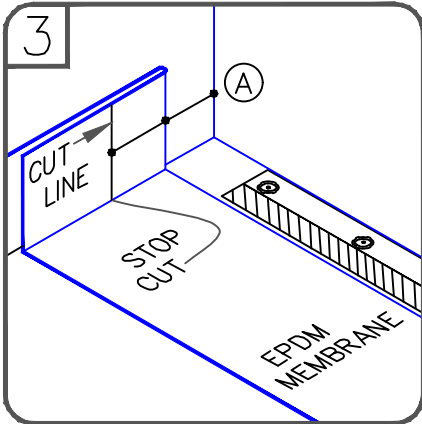
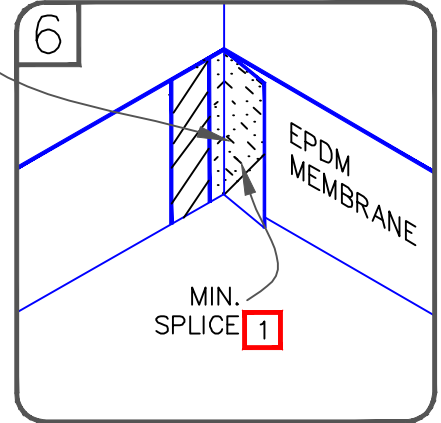

NOTES:

1. MINIMUM SPLICE WIDTH:
 - 1.1. 3" (7.5cm) UP TO 20 YEAR WARRANTIES
 - 1.2. 6" (15cm) FOR 25/30 YEAR WARRANTIES
2. REFER TO DETAIL [VGC-15.3](#) (20 YEAR) OR [VGC-15.4A](#) (25/30 YEAR) FOR INSIDE CORNER INSTALLATION REQUIREMENTS.

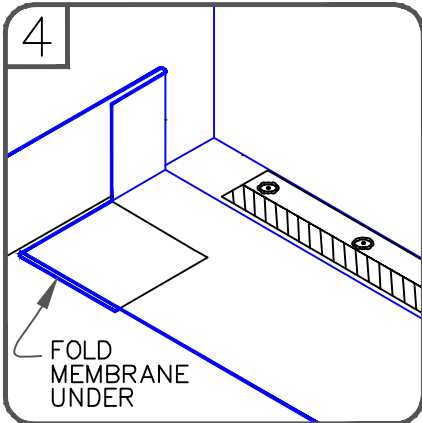
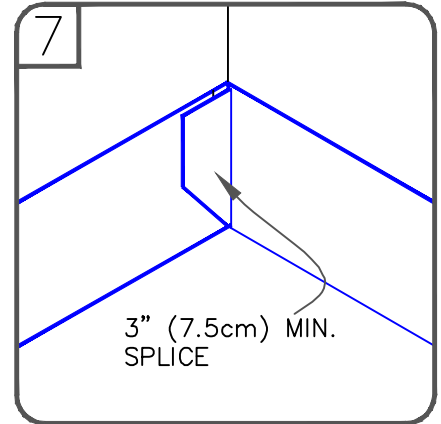

PIG EAR ON OPPOSITE WALL

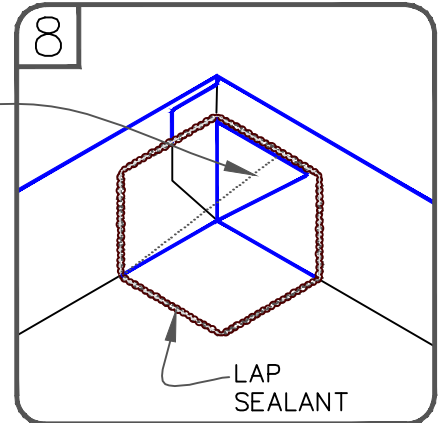

MAXIMUM WARRANTY: 30 YEARS



INSIDE CORNER WALL FLASHING WITH RTS (OPTION 1)

- EPDM MEMBRANE
- APPROVED SUBSTRATE
- SEE NOTE(S)

VersiGard COMMON DETAILS (EPDM)

VGC-15.1

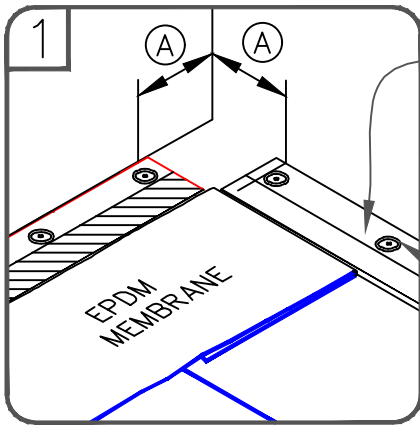

6" (15cm) QUICK-APPLIED RTS (MAY BE FASTENED INTO VERTICAL SUBSTRATE)

FORM PIG EAR WITH CONTINUOUS MEMBRANE AT CORNER AS SHOWN

VERSICO SEAM PLATE & FASTENER.

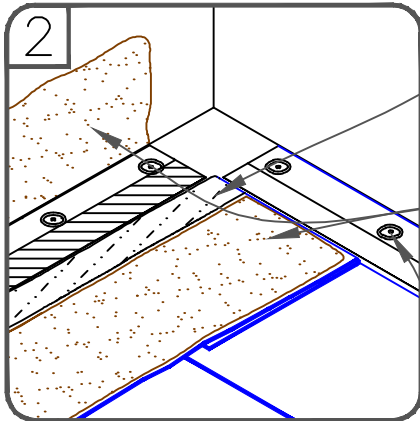
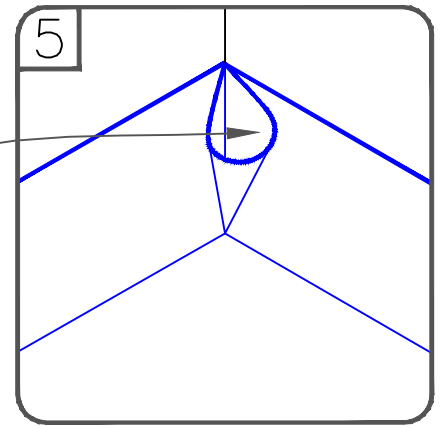

EPDM PRIMER

CUT & REMOVE EXCESSIVE MEMBRANE

VERSICO BONDING ADHESIVE

VERSICO SEAM FASTENING PLATE & FASTENER.

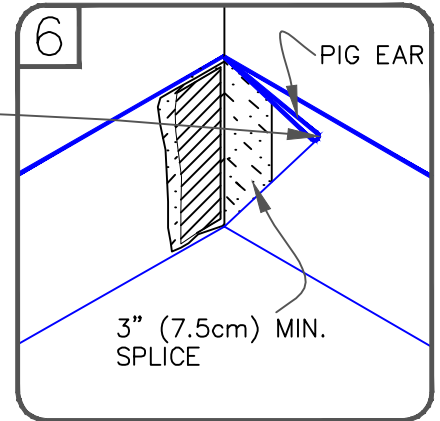

PIG EAR

3" (7.5cm) MIN. SPLICE

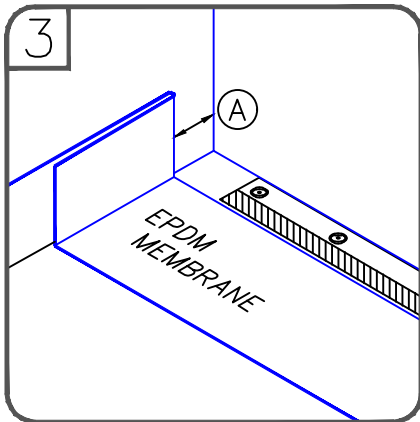

DIMENSIONS		cm	
(A)	6"	15	TO
	9"	23	

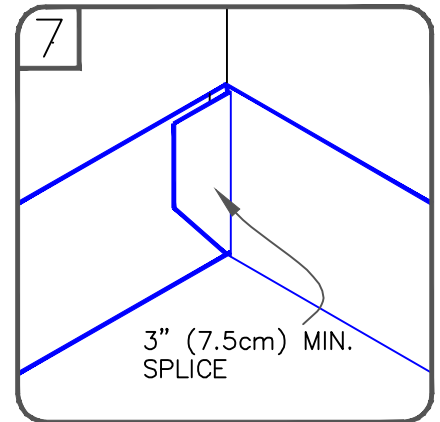

3" (7.5cm) MIN. SPLICE

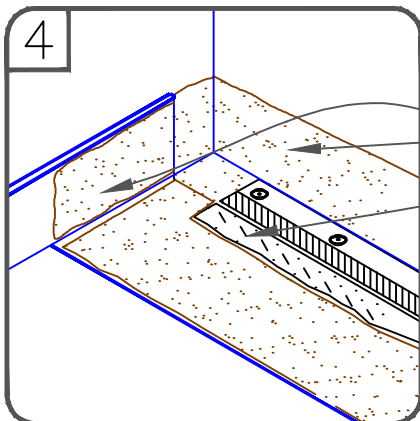

USE APPROPRIATE **VGC-9.0** DETAIL TERMINATION FOR WARRANTY DURATION (ABOVE ANTICIPATED WATER LEVEL OR SLUSH LINE)

VERSICO BONDING ADHESIVE

EPDM PRIMER

6" (15cm) WIDE QUICK-APPLIED UNCURED EPDM FLASHING AND EPDM PRIMER

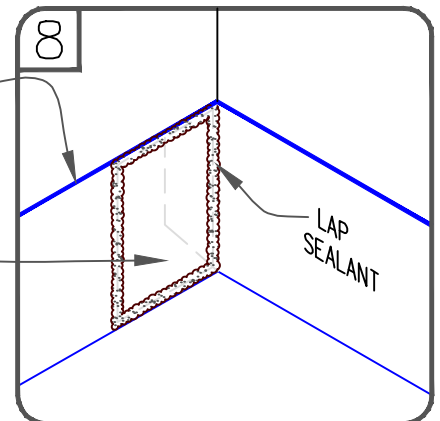



LAP SEALANT

MAXIMUM WARRANTY: 30 YEARS



INSIDE CORNER WALL FLASHING WITH RTS (OPTION 2)

-  → EPDM MEMBRANE
-  → APPROVED SUBSTRATE
-  → SEE NOTE(S)

VersiCard COMMON DETAILS (EPDM)

VGC-15.2

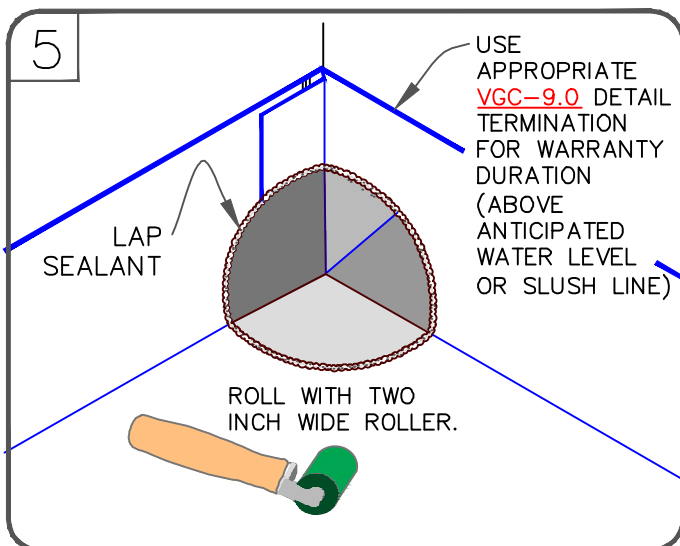
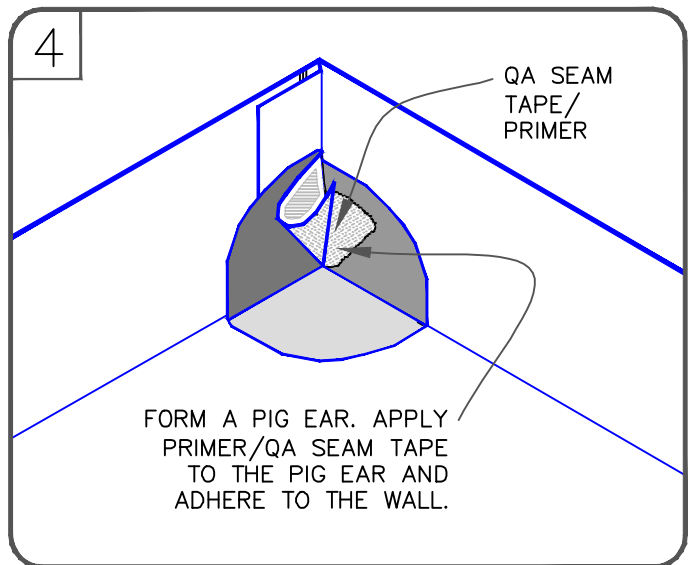
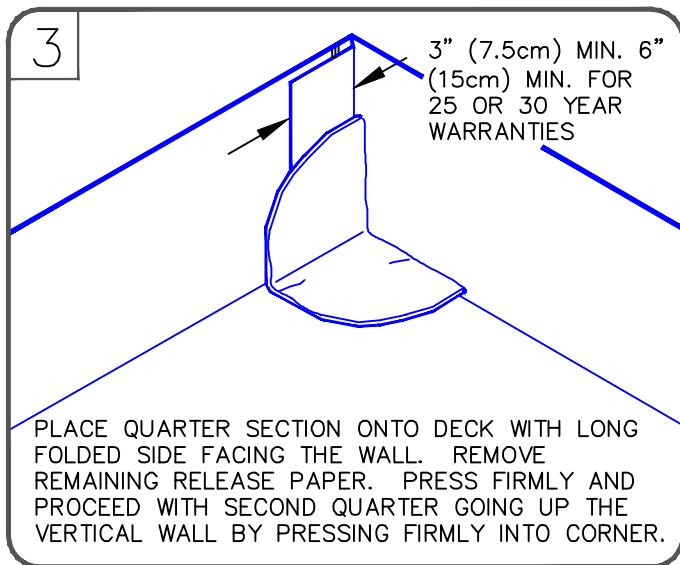
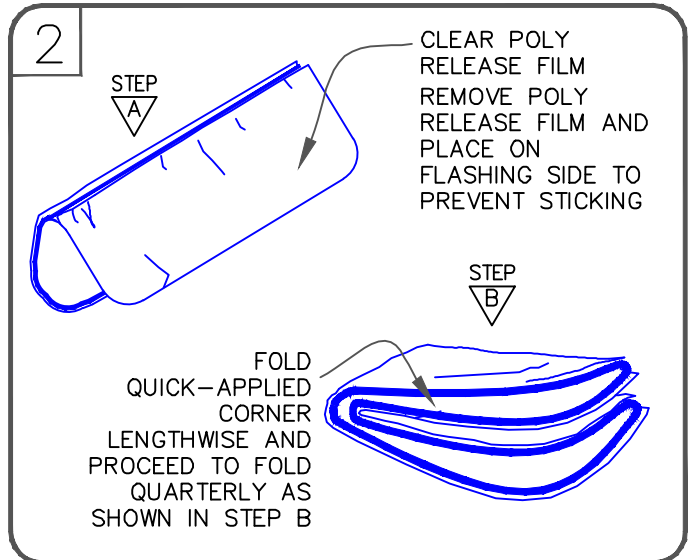
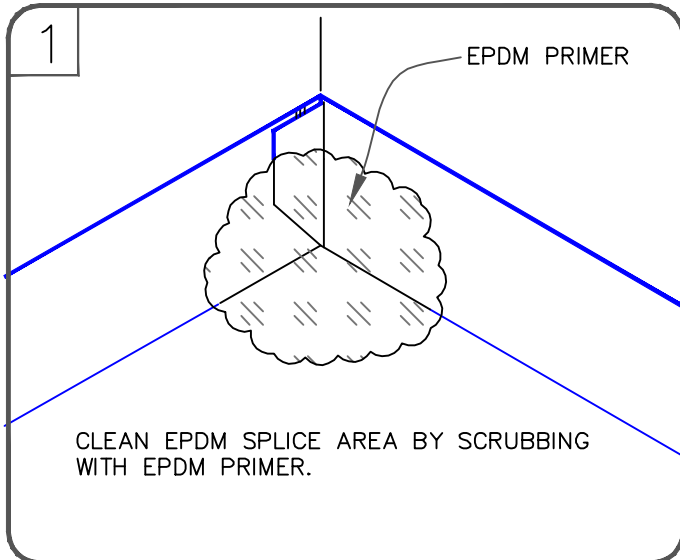

NOTES:

1. PRE-CUT 7" X 9" CORNER OR 9" X 9" QUICK-APPLIED UNCURED EPDM.
2. FOR PROJECTS WITH 25 AND 30-YEAR WARRANTIES OR WHEN USING 90-MIL MEMBRANE, INSTALL A 6" T-JOINT COVER PRIOR TO INSTALLING A 12" T-JOINT COVER. SEAL TOP LAYER WITH CONTINUOUS LAP SEALANT. PER DETAIL **VGC-15.4 A**
3. A HEAT GUN MUST BE USED WHEN FORMING QUICK-APPLIED UNCURED FLASHING IN COLDER TEMPERATURES.

MAXIMUM WARRANTY: 20 YEARS. SEE **NOTE 2**



INSIDE CORNER WITH CONTINUOUS EPDM WALL FLASHING

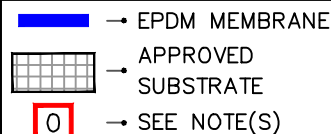

VersiGard COMMON DETAILS (EPDM)

VGC-15.3

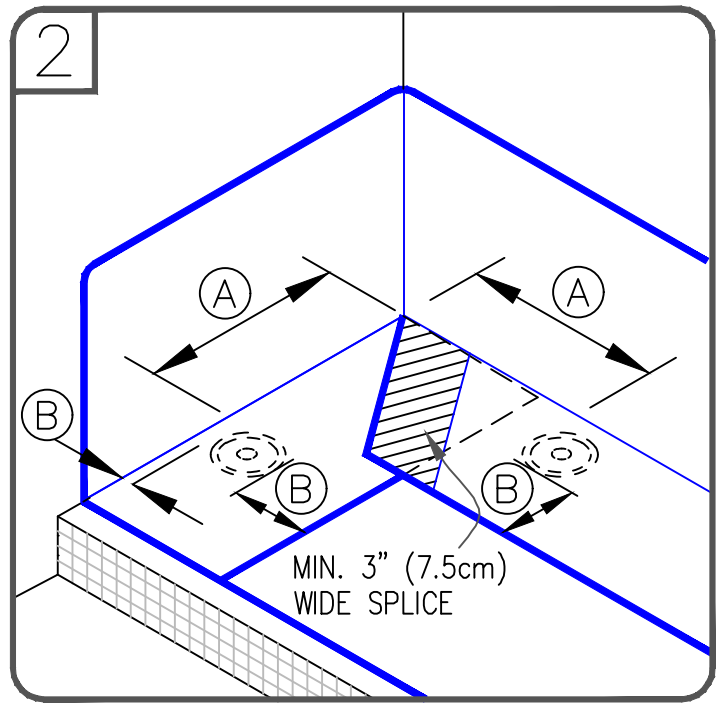
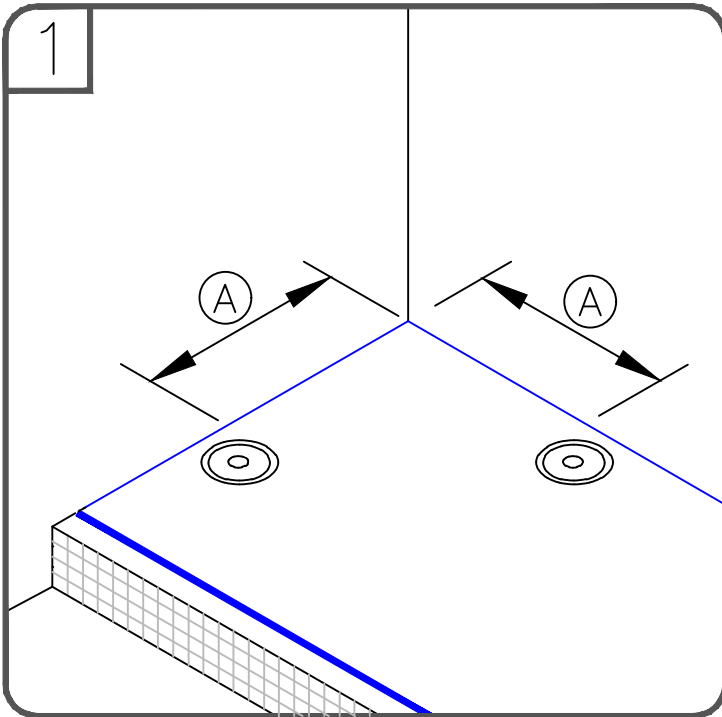

DIMENSIONS	cm	
(A) 6"	15	TO
9"	23	
(B) 3"	7.5	

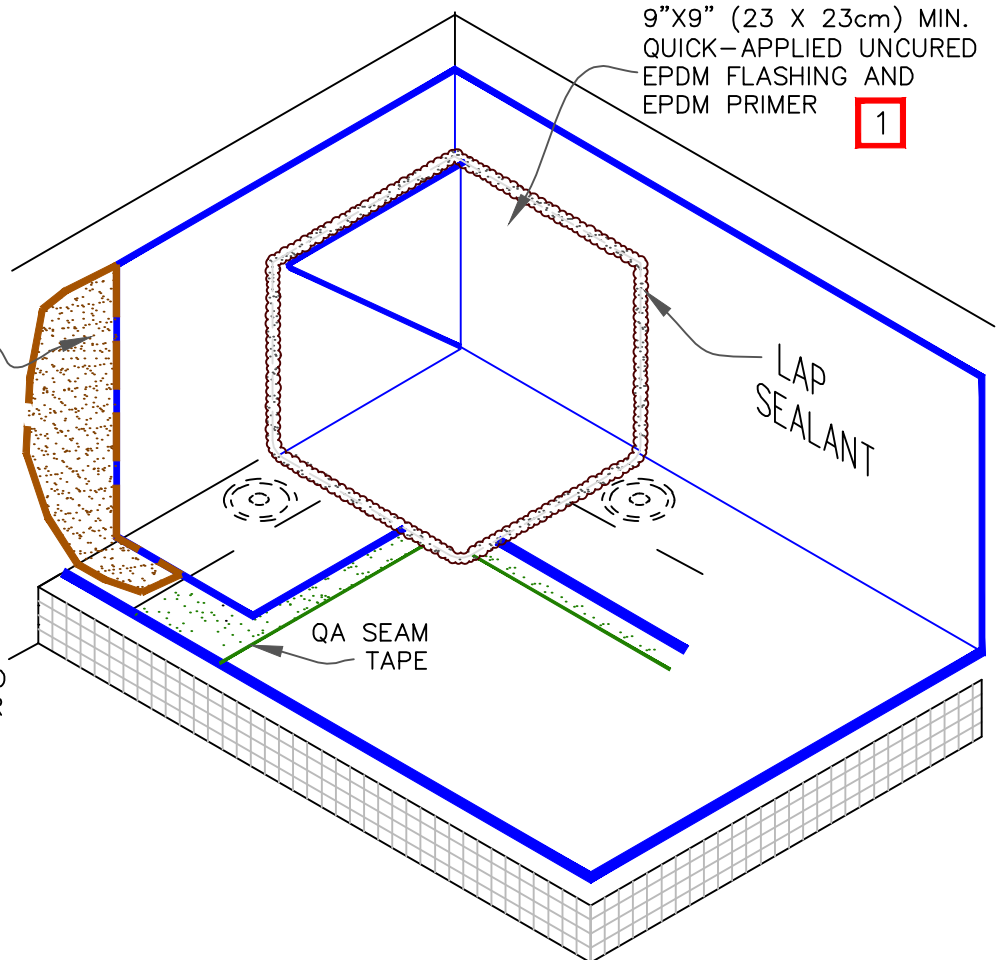

NOTES:

1. A HEAT GUN MUST BE USED WHEN FORMING QUICK-APPLIED UNCURED FLASHING IN COLDER TEMPERATURES.
2. FOR PROJECTS WITH 25 & 30-YEAR WARRANTIES OR WHEN USING 90-MIL MEMBRANE, REFER TO [DETAIL VGC-15.4A](#) FOR REQUIRED FLASHING ENHANCEMENTS.

MAXIMUM WARRANTY: 20 YEARS. SEE [NOTE 2](#)



INSIDE CORNER WITH SEPARATE EPDM WALL FLASHING

- → EPDM MEMBRANE
- APPROVED SUBSTRATE
- 0 → SEE NOTE(S)

VersiGard COMMON DETAILS (EPDM)

VGC-15.4

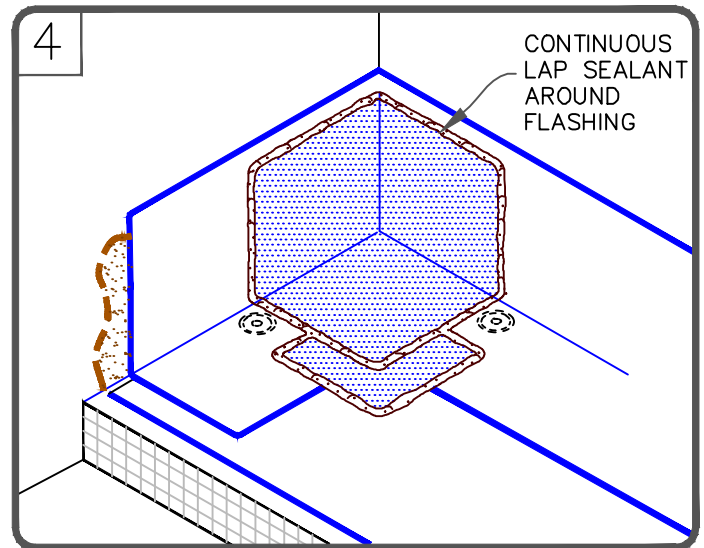
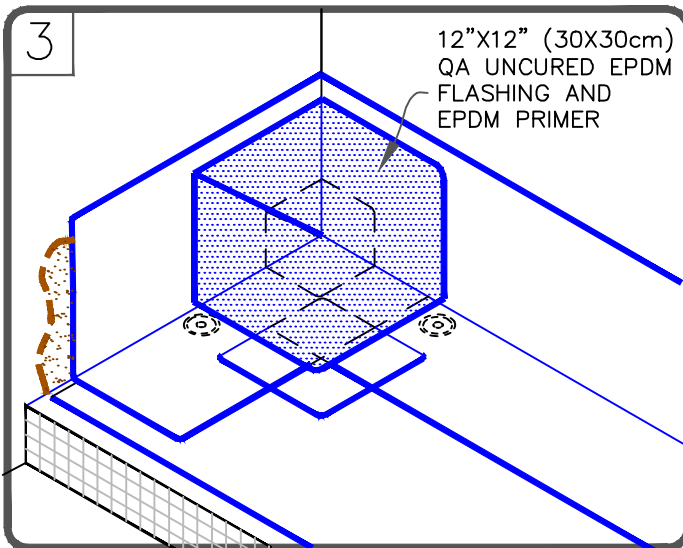
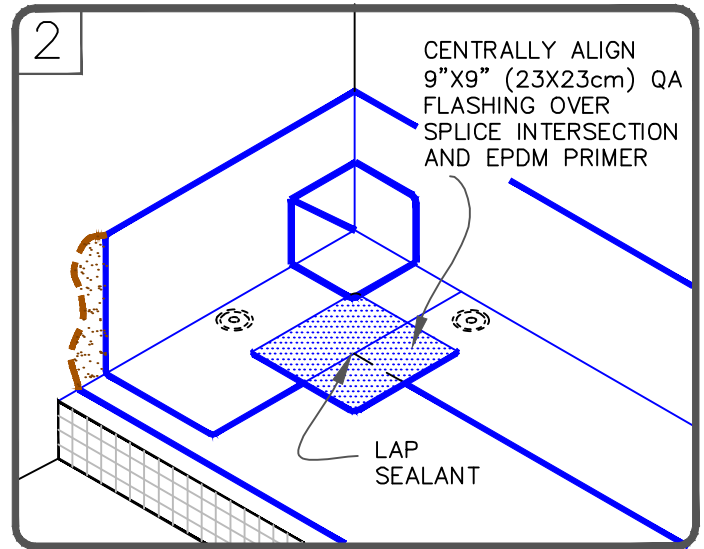
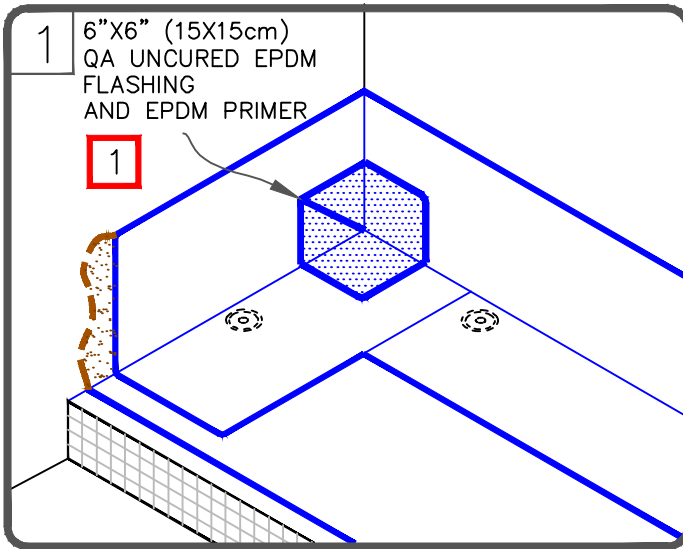



NOTES:

1. A 7"X9" (17.5cm X 23cm) QUICK-APPLIED PRE-CUT INSIDE/OUTSIDE CORNER MAY BE CUT DOWN TO 6" X 6" (7.5cm X 7.5cm).
2. A HEAT GUN MUST BE USED WHEN FORMING QUICK-APPLIED UNCURED EPDM FLASHING IN COLDER TEMPERATURES.
3. APPLY PRIMER AND QA SEAM TAPE TO ADHERE PIG EAR TO THE WALL.

MAXIMUM WARRANTY: 30 YEARS



INSIDE CORNER FLASHING FOR PROJECTS WITH 90-MIL MEMBRANE OR 30 YEAR WARRANTIES

-  → EPDM MEMBRANE
-  → APPROVED SUBSTRATE
-  → SEE NOTE(S)

VersiGard COMMON DETAILS (EPDM)

VGC-15.4A

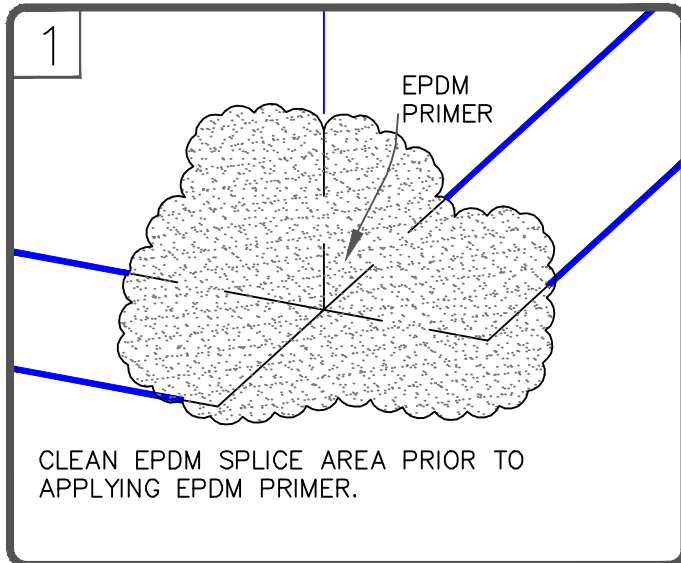

CLEAN EPDM SPLICE AREA PRIOR TO APPLYING EPDM PRIMER.

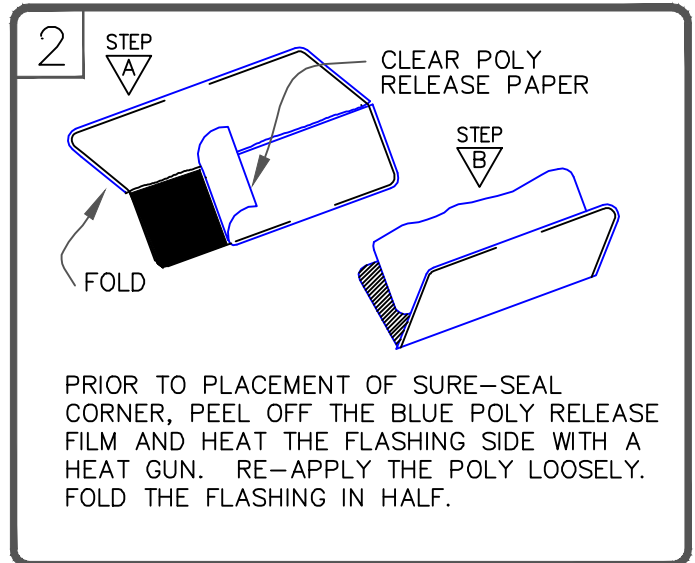

PRIOR TO PLACEMENT OF SURE-SEAL CORNER, PEEL OFF THE BLUE POLY RELEASE FILM AND HEAT THE FLASHING SIDE WITH A HEAT GUN. RE-APPLY THE POLY LOOSELY. FOLD THE FLASHING IN HALF.

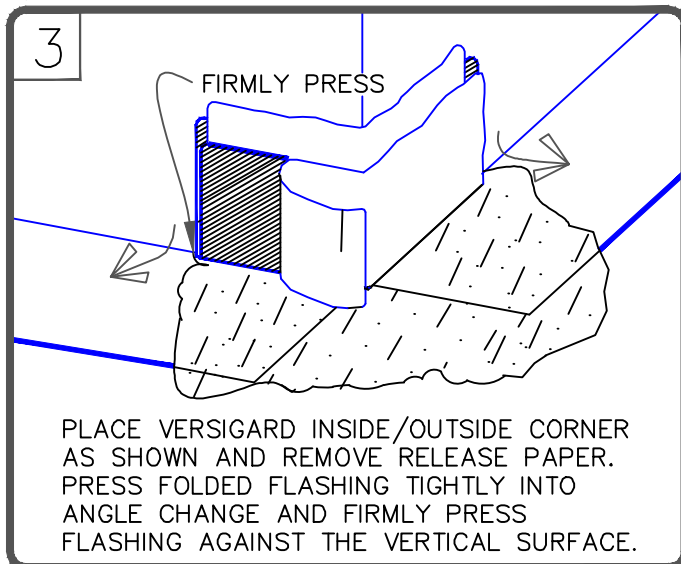

PLACE VERSIGARD INSIDE/OUTSIDE CORNER AS SHOWN AND REMOVE RELEASE PAPER. PRESS FOLDED FLASHING TIGHTLY INTO ANGLE CHANGE AND FIRMLY PRESS FLASHING AGAINST THE VERTICAL SURFACE.

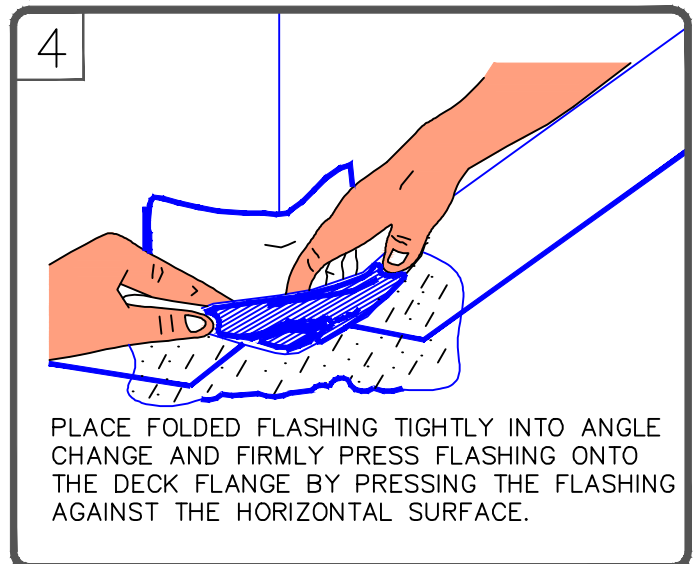

PLACE FOLDED FLASHING TIGHTLY INTO ANGLE CHANGE AND FIRMLY PRESS FLASHING ONTO THE DECK FLANGE BY PRESSING THE FLASHING AGAINST THE HORIZONTAL SURFACE.

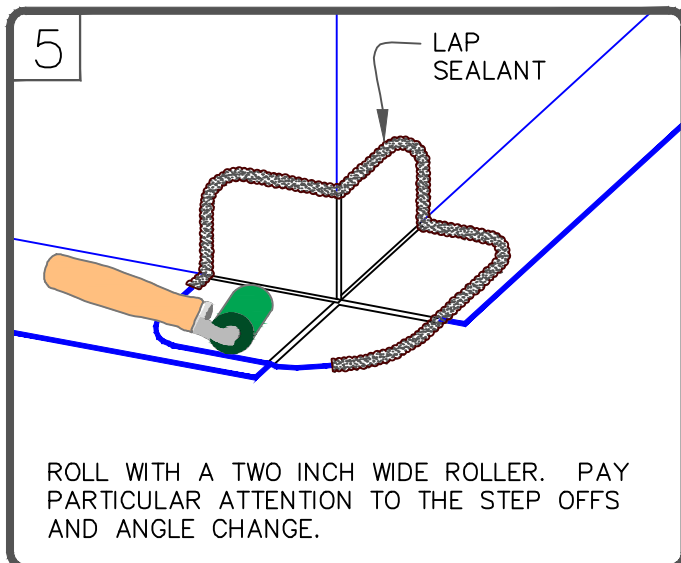

ROLL WITH A TWO INCH WIDE ROLLER. PAY PARTICULAR ATTENTION TO THE STEP OFFS AND ANGLE CHANGE.

NOTE:

- FOR PROJECTS WITH 25 & 30-YEAR WARRANTIES OR WHEN USING 90-MIL MEMBRANE, SEE [DETAIL VGC-15.7A](#) FOR REQUIRED FLASHING ENHANCEMENTS.

MAXIMUM WARRANTY: 20 YEARS. SEE [NOTE 1](#)



OUTSIDE CORNER WITH PRE-CUT QUICK-APPLIED CORNER

	→ EPDM MEMBRANE
	→ APPROVED SUBSTRATE
	→ SEE NOTE(S)

VersiGard COMMON DETAILS (EPDM)

VGC-15.5

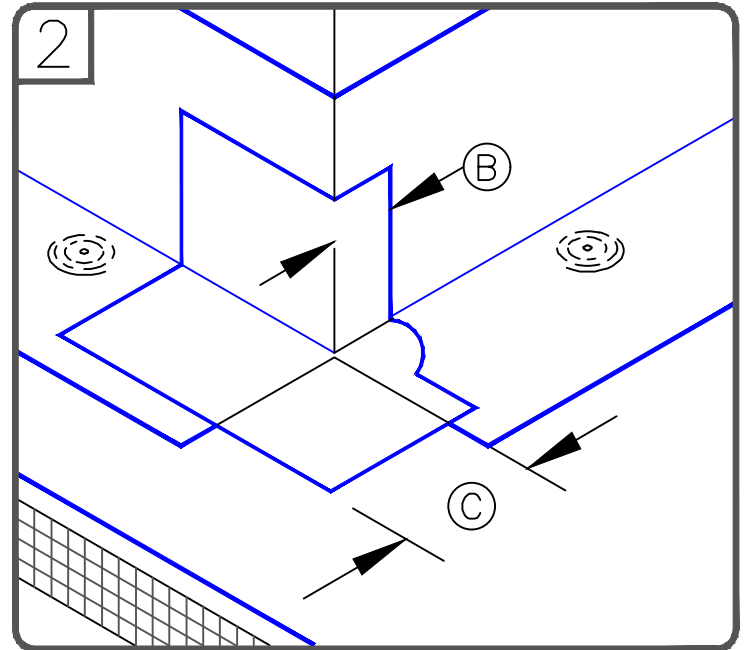
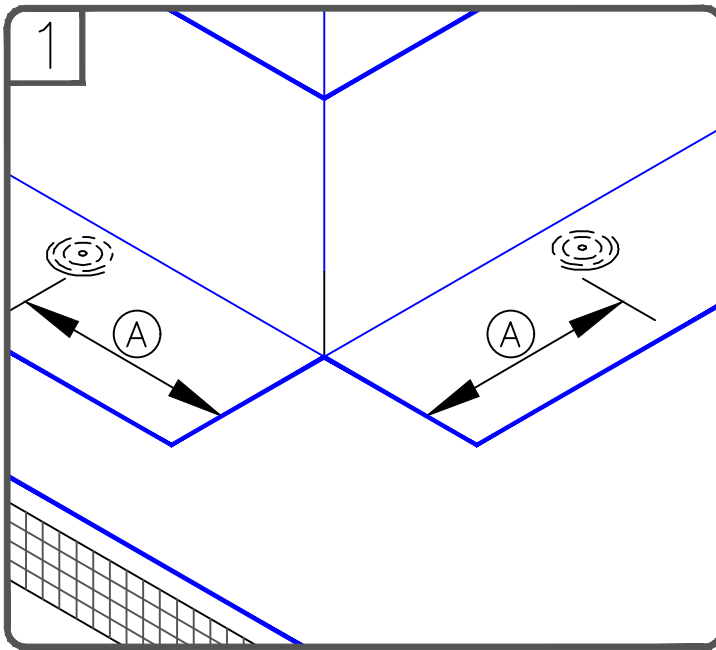

DIMENSIONS		cm	
(A)	6"	15	TO
	9"	23	
(B)	2"	5	MIN.
(C)	3"	7.5	MAX.

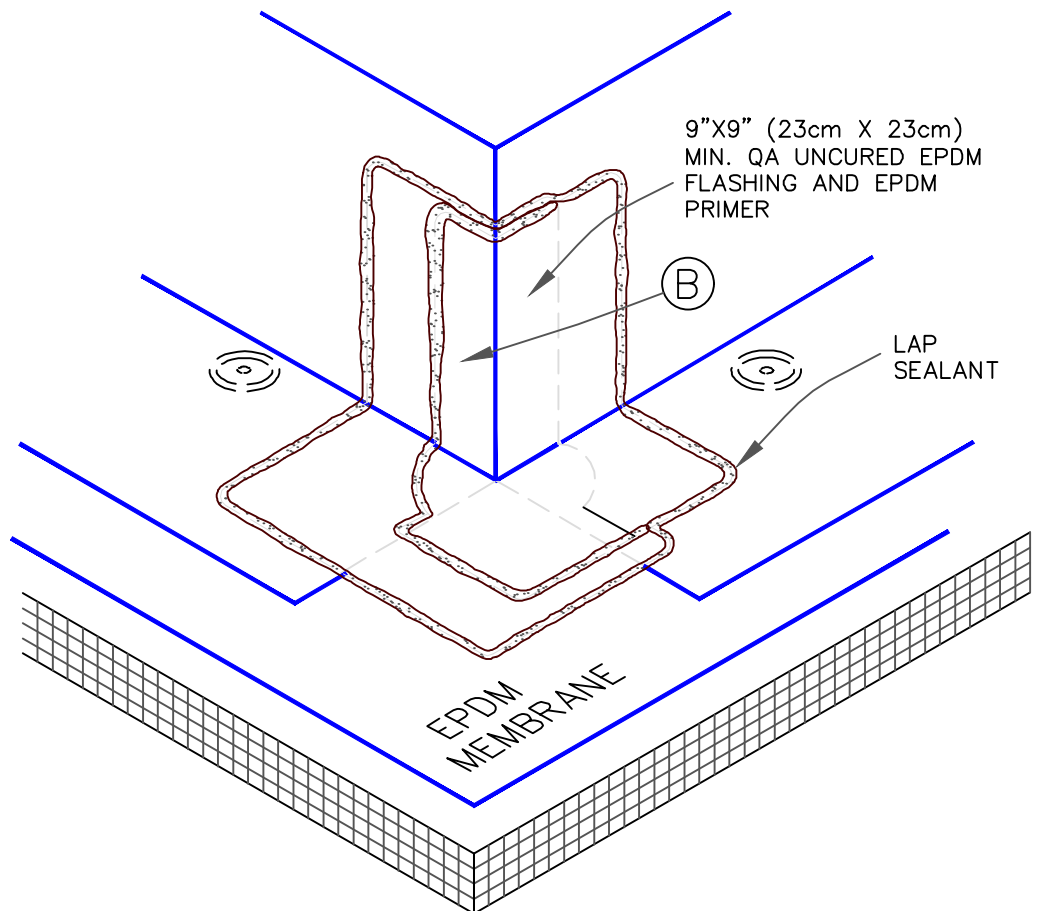



NOTES:

1. A HEAT GUN MUST BE USED WHEN FORMING QUICK-APPLIED UNCURED FLASHING IN COLDER TEMPERATURES.
2. FOR PROJECTS WITH 30-YEAR WARRANTY OR WHEN USING 90-MIL MEMBRANE, REFER TO [DETAIL VGC-15.7A](#) FOR REQUIRED FLASHING ENHANCEMENTS.

MAXIMUM WARRANTY: 25 YEARS



OUTSIDE CORNER WITH QUICK-APPLIED UNCURED EPDM FLASHING (2 PIECE)

-  → EPDM MEMBRANE
-  → APPROVED SUBSTRATE
-  → SEE NOTE(S)

VersiGard COMMON DETAILS (EPDM)

VGC-15.6

1

FASTEN MEMBRANE AND FLASH CURB OR WALL WITH CURED EPDM MEMBRANE FOLLOWING STANDARD PROCEDURES USING BONDING ADHESIVE and QA SEAM TAPE.

2

CUT A 9"x9" (23cm x 23cm) SECTION OF QUICK-APPLIED UNCURED EPDM FLASHING AND MAKE ROUNDED CORNERS AS SHOWN.

3

AFTER APPLYING EPDM PRIMER, REMOVE AND REPLACE POLY BACKING. FOLD FLASHING IN HALF WITH ROUNDED PORTION TURNED UP. CENTER FLASHING ON CORNER AND FIRMLY PRESS AGAINST VERTICAL SURFACE.

4

ROLL AND CREASE FLASHING TIGHTLY INTO ANGLE CHANGE AND FIRMLY ROLL FLASHING ONTO THE DECK MEMBRANE.

5 LAP SEALANT

AFTER ADHERING, ROLL WITH A TWO INCH WIDE STEEL HAND ROLLER. PAY PARTICULAR ATTENTION TO THE STEP OFFS AND ANGLE CHANGES.

DIMENSIONS		cm	
(A)	6"	15	TO
	9"	23	

NOTES:

- FOR PROJECTS WITH 25 & 30-YEAR WARRANTIES OR WHEN USING 90-MIL MEMBRANE, REFER TO [DETAIL VGC-15.7A](#) FOR REQUIRED FLASHING ENHANCEMENTS.
- A HEAT GUN MUST BE USED WHEN FORMING QUICK-APPLIED UNCURED EPDM FLASHING IN COLDER TEMPERATURES.

MAXIMUM WARRANTY: 20 YEARS. SEE [NOTE 1](#).



OUTSIDE CORNER WITH QUICK-APPLIED UNCURED EPDM FLASHING (1 PIECE)

- EPDM MEMBRANE
- APPROVED SUBSTRATE
- SEE NOTE(S)

VersiCard COMMON DETAILS (EPDM)

VGC-15.7

1

6" (15cm)

FASTEN MEMBRANE AND FLASH CURB OR WALL WITH CURED EPDM MEMBRANE FOLLOWING STANDARD PROCEDURES.

2

CENTER FOLD LINE

USE PRE-CUT T-JOINT COVERS OR CUT A 6"x6" (15X15cm) & 12"x12" (30X30cm) SECTION OF QUICK-APPLIED UNCURED FLASHING AND ROUND CORNERS

3

EPDM PRIMER

CLEAN EPDM SPLICE AREA WITH WEATHERED MEMBRANE CLEANER PRIOR TO APPLYING EPDM PRIMER

4

POLY FILM

REMOVE & REPLACE POLY BACKING ON FLASHING. FOLD FLASHING IN HALF WITH ROUNDED PORTION TURNED UP. CENTER ON CORNER & FIRMLY PRESS AGAINST VERTICAL SURFACE

5

ROLL & CREASE FLASHING TIGHTLY INTO ANGLE CHANGE & FIRMLY ROLL FLASHING ONTO THE DECK MEMBRANE

USE HEAT GUN TO WARM THE FLASHING IN COLD WEATHER

6

ROLL WITH A TWO INCH WIDE STEEL HAND ROLLER. PAY PARTICULAR ATTENTION TO THE STEP OFFS AND ANGLE CHANGES

7

ROLL STEP OFFS AND ANGLE CHANGES

8

APPLY EPDM PRIMER TO SPLICE AREA. INSTALL THE 12"x12" (30cmX30cm) SECTION OF QUICK-APPLIED UNCURED EPDM FLASHING CENTERED OVER PREVIOUSLY APPLIED FLASHING.

9

SEAL ALL EDGES WITH LAP SEALANT AS SHOWN

MAXIMUM WARRANTY: 30 YEARS



OUTSIDE CORNER FLASHING FOR PROJECTS WITH 90-MIL MEMBRANE OR 30 YEAR WARRANTIES

- EPDM MEMBRANE
- APPROVED SUBSTRATE
- SEE NOTE(S)

VersiGard COMMON DETAILS (EPDM)

VGC-15.7A

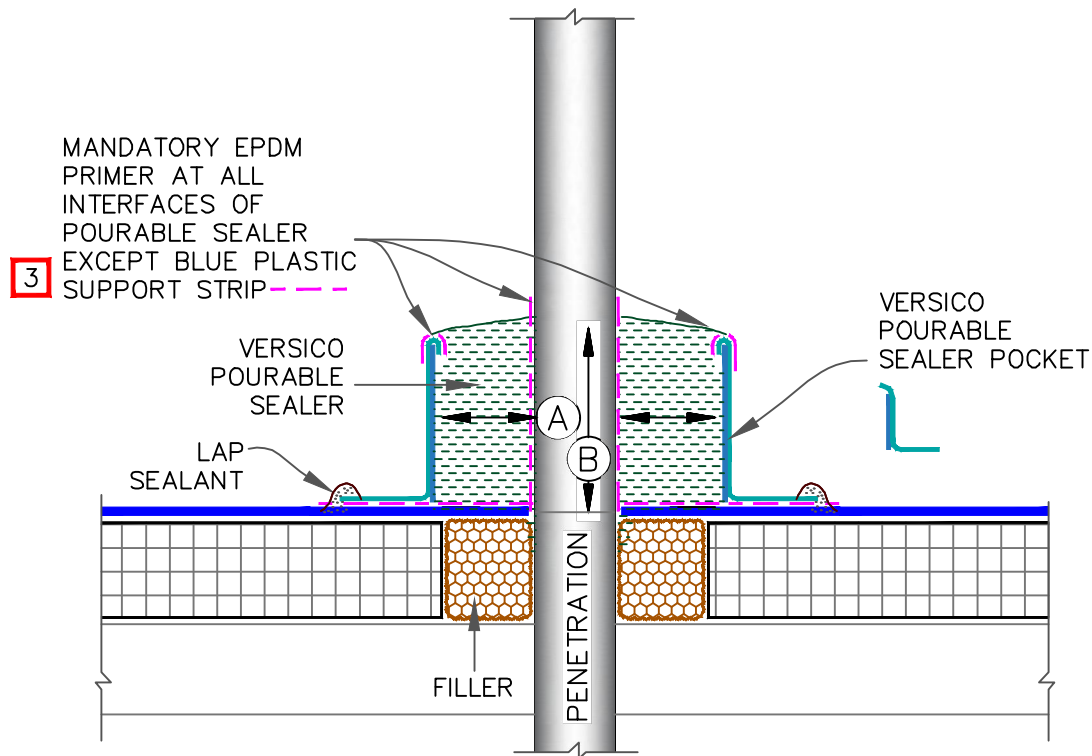

NOTES:

1. THE MAXIMUM ALLOWABLE SURFACE TEMPERATURE OF THE PENETRATION SHALL NOT EXCEED 180° F (82° C).
2. ALL DEBRIS (PAINT, RUST, LEAD, OTHER FLASHINGS, ETC.) MUST BE REMOVED FROM THE PENETRATION.
3. ALL SURFACES MUST BE PRIMED WITH EPDM PRIMER PRIOR TO APPLYING POURABLE SEALER. DO NOT PRIME THE BLUE PLASTIC SUPPORT STRIP.
4. POURABLE SEALER MUST COMPLETELY FILL POURABLE SEALER POCKET TO PREVENT PONDING OF WATER.
5. POURABLE SEALER MUST CONTACT PRIMED QUICK-APPLIED UNCURED FLASHING AND DECK MEMBRANE.
6. SECUREMENT IS REQUIRED FOR POURABLE SEALER POCKETS WHICH ARE GREATER THAN 18" (46cm) IN DIAMETER. REFER TO SPECIFICATIONS.
7. ON MECHANICALLY-ATTACHED ROOFING SYSTEMS, ADDITIONAL MEMBRANE SECUREMENT IS REQUIRED (SIMILAR TO [VGMA-8.1](#)) REGARDLESS OF SIZE OR DIAMETER.
8. MINIMUM 1" (2.5cm) CLEARANCE REQUIRED BETWEEN PENETRATIONS.

DIMENSIONS	cm	
(A)	1"	2.5 MIN.
(B)	2"	5 MIN.

MAXIMUM WARRANTY: 20 YEARS



QUICK-APPLIED POURABLE SEALER POCKET

- EPDM MEMBRANE
- APPROVED SUBSTRATE
- SEE NOTE(S)

VersiGard COMMON DETAILS (EPDM)

VGC-16.1

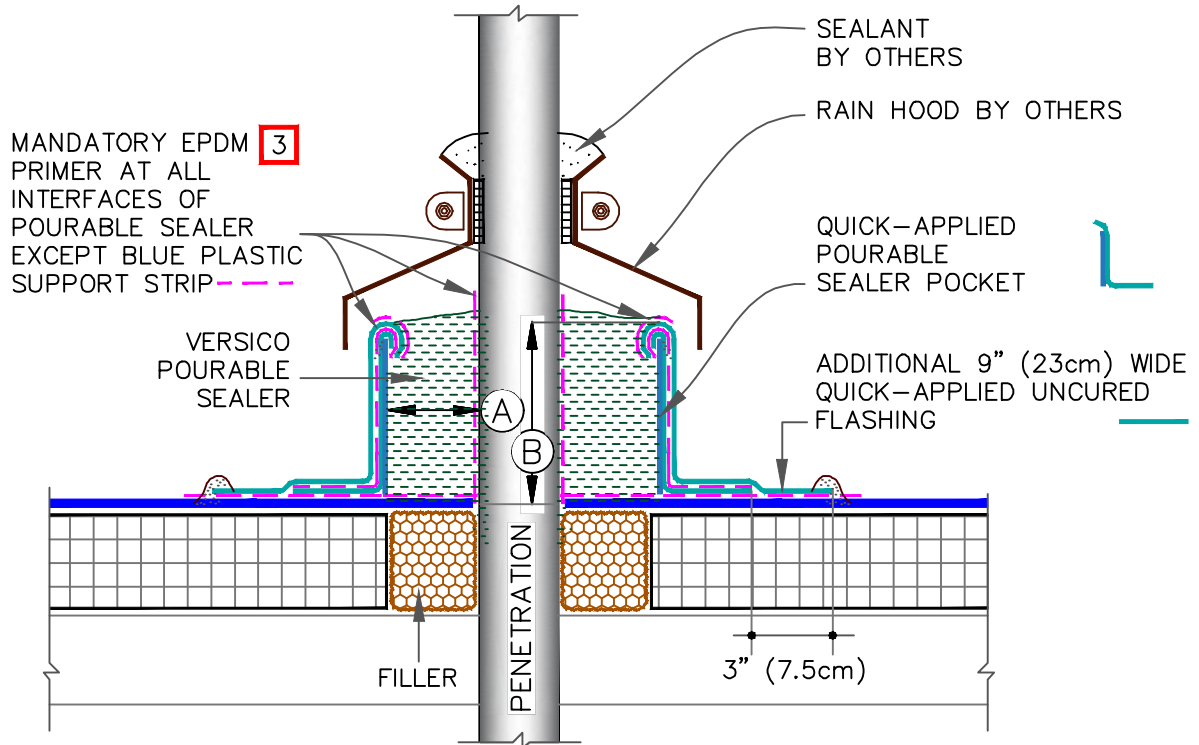

NOTES:

1. THE MAXIMUM ALLOWABLE SURFACE TEMPERATURE OF THE PENETRATION SHALL NOT EXCEED 180° F (82° C).
2. ALL DEBRIS (PAINT, RUST, LEAD, OTHER FLASHINGS, ETC.) MUST BE REMOVED FROM THE PENETRATION.
3. ALL SURFACES MUST BE PRIMED WITH EPDM PRIMER PRIOR TO APPLYING POURABLE SEALER. DO NOT PRIME THE BLUE PLASTIC SUPPORT STRIP.
4. POURABLE SEALER MUST COMPLETELY FILL POURABLE SEALER POCKET TO PREVENT PONDING OF WATER.
5. POURABLE SEALER MUST CONTACT PRIMED QUICK-APPLIED UNCURED EPDM FLASHING AND DECK MEMBRANE.
6. SECUREMENT IS REQUIRED FOR POURABLE SEALER POCKETS WHICH ARE GREATER THAN 18" (46cm) IN DIAMETER. REFER TO SPECIFICATIONS.
7. ON MECHANICALLY-ATTACHED ROOFING SYSTEMS, ADDITIONAL MEMBRANE SECUREMENT IS REQUIRED (SIMILAR TO [DETAIL VGMA-8.1](#)) REGARDLESS OF SIZE OR DIAMETER.
8. MINIMUM 1" (2.5cm) CLEARANCE REQUIRED BETWEEN PENETRATIONS.

DIMENSIONS	cm		
(A)	1"	2.5	MIN.
(B)	2"	5	MIN.

MAXIMUM WARRANTY: 30 YEARS



QUICK-APPLIED POURABLE SEALER POCKET 30 YEAR WARRANTIES)

- EPDM MEMBRANE
- APPROVED SUBSTRATE
- SEE NOTE(S)

VersiCard COMMON DETAILS (EPDM)

VGC-16.1A

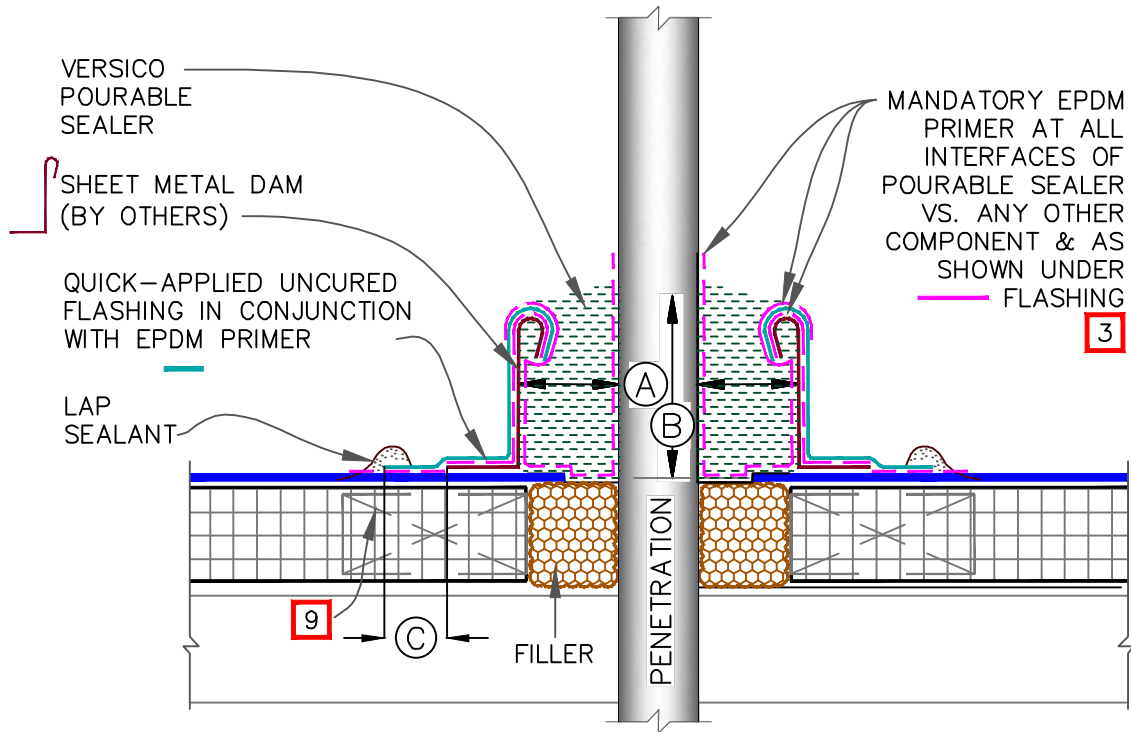

MANDATORY EPDM PRIMER AT ALL INTERFACES OF POURABLE SEALER VS. ANY OTHER COMPONENT & AS SHOWN UNDER FLASHING **3**

NOTES:

1. THE MAXIMUM ALLOWABLE SURFACE TEMPERATURE OF THE PENETRATION SHALL NOT EXCEED 180° F (82° C).
2. ALL DEBRIS (PAINT, RUST, LEAD, OTHER FLASHINGS, ETC.) MUST BE REMOVED FROM THE PENETRATION.
3. ALL SURFACES MUST BE PRIMED WITH EPDM PRIMER PRIOR TO APPLYING POURABLE SEALER.
4. POURABLE SEALER MUST COMPLETELY FILL POURABLE SEALER POCKET TO PREVENT PONDING OF WATER.
5. POURABLE SEALER MUST CONTACT PRIMED QUICK-APPLIED UNCURED EPDM FLASHING AND DECK MEMBRANE.
6. SECUREMENT IS REQUIRED FOR POURABLE SEALER POCKETS WHICH ARE GREATER THAN 18" (46cm) IN DIAMETER. REFER TO SPECIFICATIONS.
7. ON MECHANICALLY-ATTACHED ROOFING SYSTEMS, ADDITIONAL MEMBRANE SECUREMENT IS REQUIRED (SIMILAR TO [DETAIL_VGMA-8.1](#)) REGARDLESS OF SIZE AND DIAMETER, UNLESS WOOD NAILERS ARE PRESENT.
8. DECK FLANGE MUST BE CONTINUOUS WITH ROUNDED CORNERS.
9. WHEN ANY ONE SIDE OF THE FIELD FABRICATED POURABLE SEALER POCKET EXCEEDS 12" (30cm), USE WOOD BLOCKING TO ANCHOR SHEET METAL.
10. MINIMUM 1" (2.5cm) CLEARANCE REQUIRED BETWEEN PENETRATIONS.

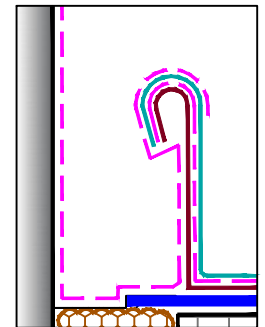

MANDATORY EPDM PRIMER AT ALL INTERFACES OF POURABLE SEALER VS. ANY OTHER COMPONENT & AS SHOWN UNDER FLASHING

DIMENSIONS		cm	
(A)	1"	2.5	MIN.
(B)	2"	5	MIN.
(C)	3"	7.5	

MAXIMUM WARRANTY: 20 YEARS



FIELD FABRICATED POURABLE SEALER POCKET

- EPDM MEMBRANE
- APPROVED SUBSTRATE
- SEE NOTE(S)

VersiGard COMMON DETAILS (EPDM)

VGC-16.2

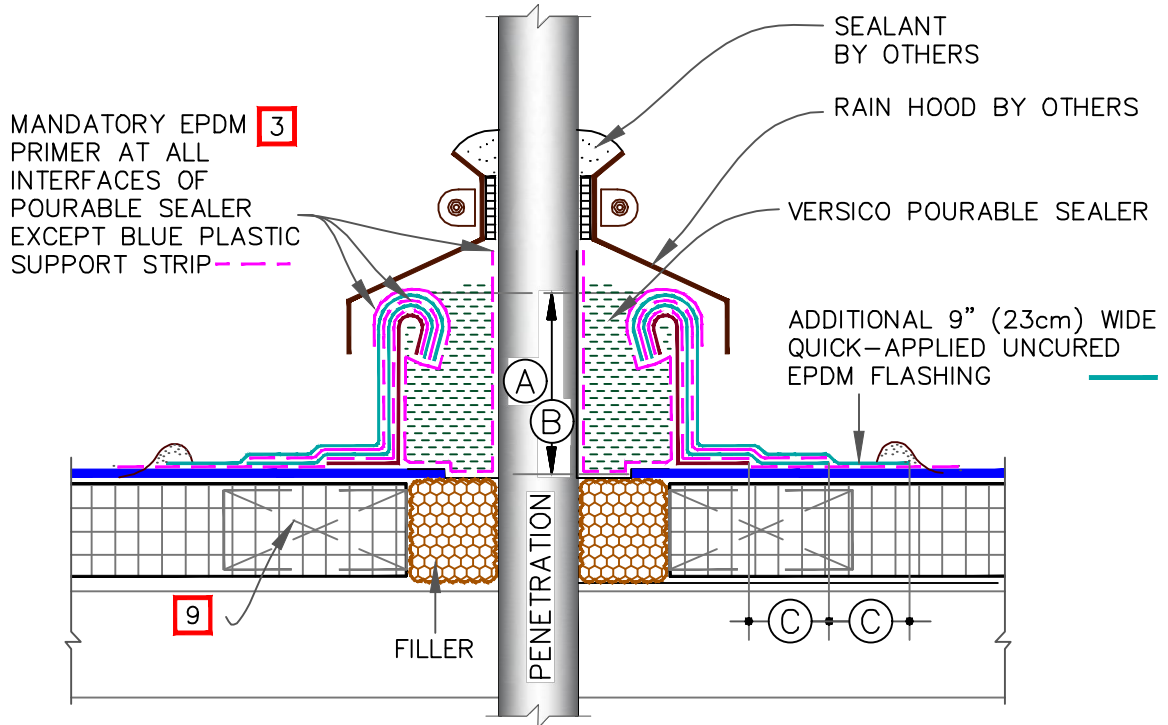

NOTES:

1. THE MAXIMUM ALLOWABLE SURFACE TEMPERATURE OF THE PENETRATION SHALL NOT EXCEED 180° F (82° C).
2. ALL DEBRIS (PAINT, RUST, LEAD, OTHER FLASHINGS, ETC.) MUST BE REMOVED FROM THE PENETRATION.
3. ALL SURFACES MUST BE PRIMED WITH EPDM PRIMER PRIOR TO APPLYING POURABLE SEALER.
4. POURABLE SEALER MUST COMPLETELY FILL POURABLE SEALER POCKET TO PREVENT PONDING OF WATER.
5. POURABLE SEALER MUST CONTACT PRIMED QUICK-APPLIED UNCURED EPDM FLASHING AND DECK MEMBRANE.
6. SECUREMENT IS REQUIRED FOR POURABLE SEALER POCKETS WHICH ARE GREATER THAN 18" (46cm) IN DIAMETER. REFER TO SPECIFICATIONS.
7. ON MECHANICALLY-ATTACHED ROOFING SYSTEMS, ADDITIONAL MEMBRANE SECUREMENT IS REQUIRED (SIMILAR TO [DETAIL VGMA-8.1](#)) REGARDLESS OF SIZE AND DIAMETER, UNLESS WOOD NAILERS ARE PRESENT.
8. DECK FLANGE MUST BE CONTINUOUS WITH ROUNDED CORNERS.
9. WHEN ANY ONE SIDE OF THE FIELD FABRICATED POURABLE SEALER POCKET EXCEEDS 12" (30cm), USE WOOD BLOCKING TO ANCHOR SHEET METAL.
10. MINIMUM 1" (2.5cm) CLEARANCE REQUIRED BETWEEN PENETRATIONS.

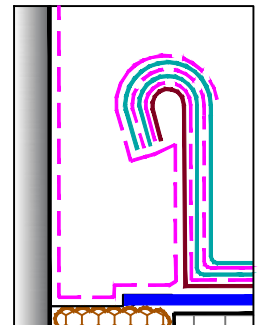

MANDATORY EPDM PRIMER AT ALL INTERFACES OF POURABLE SEALER VS. ANY OTHER COMPONENT & AS SHOWN UNDER FLASHING

DIMENSIONS		cm	
(A)	1"	2.5	MIN.
(B)	2"	5	MIN.
(C)	3"	7.5	

MAXIMUM WARRANTY: 30 YEARS



FIELD FABRICATED POURABLE SEALER POCKET (30 YEAR WARRANTIES)

- EPDM MEMBRANE
- APPROVED SUBSTRATE
- 0 → SEE NOTE(S)

VersiGard COMMON DETAILS (EPDM)

VGC-16.2A

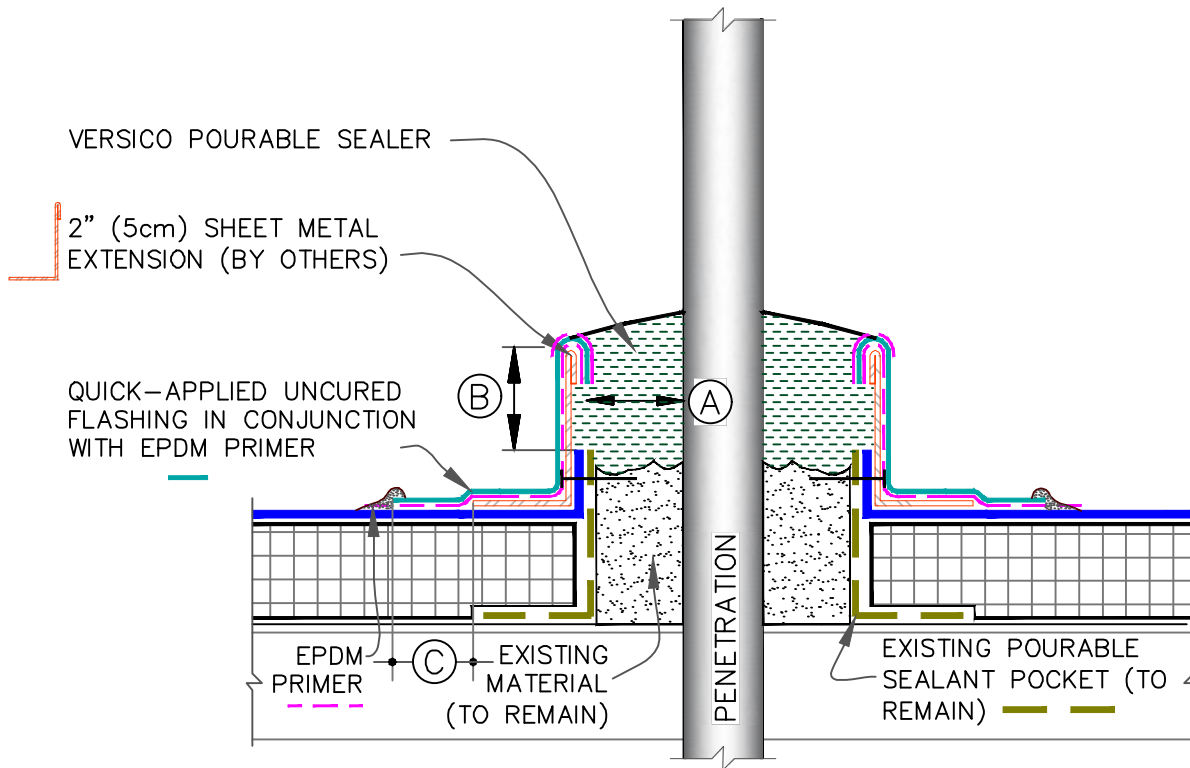

NOTES:

1. THE MAXIMUM ALLOWABLE SURFACE TEMPERATURE OF THE PENETRATION SHALL NOT EXCEED 180° F (82° C).
2. ALL DEBRIS (PAINT, RUST, LEAD, OTHER FLASHINGS, ETC.) MUST BE REMOVED FROM THE PENETRATION.
3. ALL SURFACES MUST BE PRIMED WITH EPDM PRIMER PRIOR TO APPLYING POURABLE SEALER.
4. POURABLE SEALER MUST COMPLETELY FILL POURABLE SEALER POCKET TO PREVENT PONDING OF WATER.
5. POURABLE SEALER MUST CONTACT PRIMED QUICK-APPLIED UNCURED EPDM FLASHING.
6. SHAPE METAL DAM TO FIT EXISTING PITCH POCKET.
7. SECUREMENT IS REQUIRED FOR POURABLE SEALER POCKETS WHICH ARE GREATER THAN 18" (46cm) IN DIAMETER. REFER TO SPECIFICATIONS.
8. ON MECHANICALLY-ATTACHED ROOFING SYSTEMS, ADDITIONAL MEMBRANE SECUREMENT IS REQUIRED (SIMILAR TO [DETAIL VGMA-8.1](#)) REGARDLESS OF SIZE OR DIAMETER.
9. MINIMUM 1" (2.5cm) CLEARANCE REQUIRED BETWEEN PENETRATIONS.

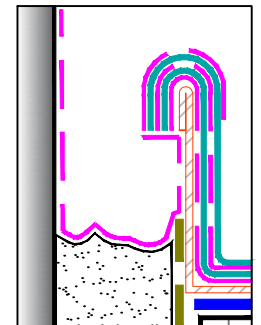

MANDATORY EPDM PRIMER AT ALL INTERFACES OF POURABLE SEALER

DIMENSIONS		cm	
(A)	1"	2.5	MIN.
(B)	2"	5	MIN.
(C)	3"	7.5	

MAXIMUM WARRANTY: 20 YEARS



EXTENDED POURABLE SEALER POCKET

- EPDM MEMBRANE
- APPROVED SUBSTRATE
- SEE NOTE(S)

VersiGard COMMON DETAILS (EPDM)

VGC-16.3

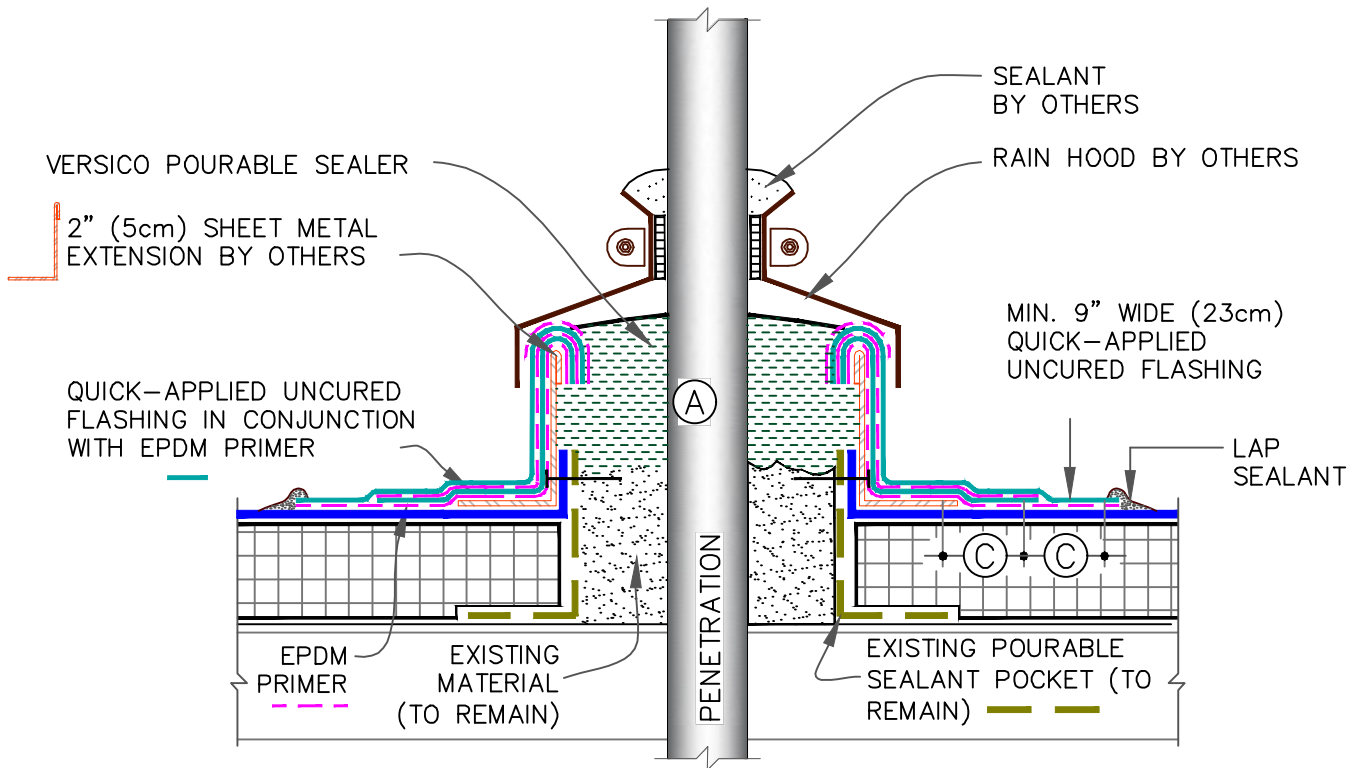

NOTES:

1. THE MAXIMUM ALLOWABLE SURFACE TEMPERATURE OF THE PENETRATION SHALL NOT EXCEED 180° F (82° C).
2. ALL DEBRIS (PAINT, RUST, LEAD, OTHER FLASHINGS, ETC.) MUST BE REMOVED FROM THE PENETRATION.
3. ALL SURFACES MUST BE PRIMED WITH EPDM PRIMER PRIOR TO APPLYING POURABLE SEALER.
4. POURABLE SEALER MUST COMPLETELY FILL POURABLE SEALER POCKET TO PREVENT PONDING OF WATER.
5. POURABLE SEALER MUST CONTACT PRIMED QUICK-APPLIED UNCURED EPDM FLASHING.
6. SHAPE METAL DAM TO FIT EXISTING PITCH POCKET.
7. SECUREMENT IS REQUIRED FOR POURABLE SEALER POCKETS WHICH ARE GREATER THAN 18" (46cm) IN DIAMETER. REFER TO SPECIFICATIONS.
8. ON MECHANICALLY-ATTACHED ROOFING SYSTEMS, ADDITIONAL MEMBRANE SECUREMENT IS REQUIRED (SIMILAR TO [DETAIL VGMA-8.1](#)) REGARDLESS OF SIZE OR DIAMETER.
9. MINIMUM 1" (2.5cm) CLEARANCE REQUIRED BETWEEN PENETRATIONS.

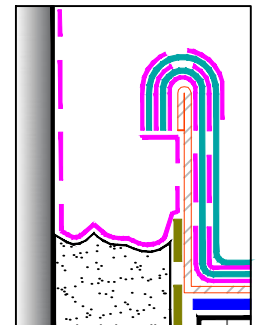

MANDATORY EPDM PRIMER AT ALL INTERFACES OF POURABLE SEALER

DIMENSIONS		cm	
(A)	1"	2.5	MIN.
(B)	2"	5	MIN.
(C)	3"	7.5	

MAXIMUM WARRANTY: 30 YEARS



EXTENDED POURABLE SEALER POCKET (30 YEAR WARRANTIES)

- EPDM MEMBRANE
- APPROVED SUBSTRATE
- SEE NOTE(S)

VersiGard COMMON DETAILS (EPDM)

VGC-16.3A

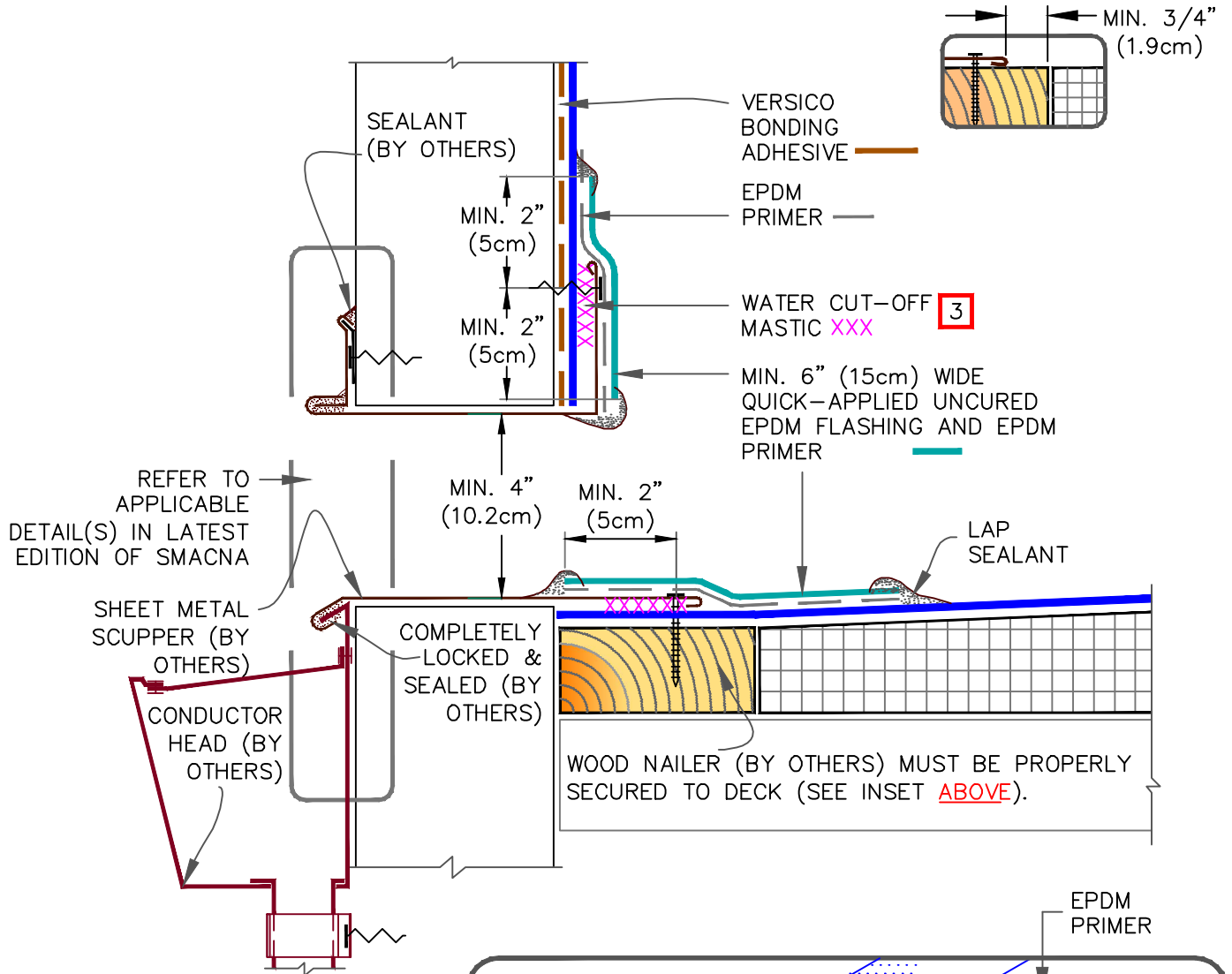

NOTES:

1. METAL SCUPPER BOX MUST HAVE CONTINUOUS FLANGES WITH ROUNDED CORNERS. SOLDER ALL SCUPPER SEAMS WATER-TIGHT.
2. WATER CUT-OFF MASTIC UNDER SCUPPER FLANGE MUST BE UNDER CONSTANT COMPRESSION.
3. CLEAN METAL FLANGE WITH WEATHERED MEMBRANE CLEANER; AND ALLOW TO DRY.
4. SCUPPERS WITHOUT A CONTINUOUS WATERTIGHT DESIGN MUST BE FLASHED IN PER [VGC-15](#) OUTSIDE CORNER DETAILS.

MAXIMUM WARRANTY: 25 YEARS

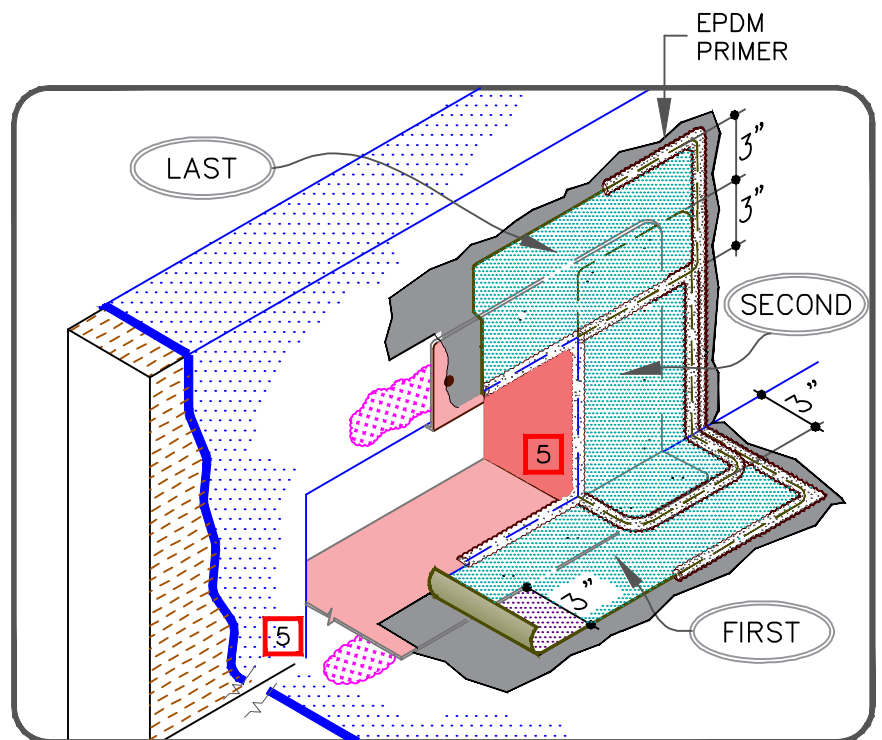

SCUPPER: SINGLE LAYER FLASHING

	→ EPDM MEMBRANE
	→ APPROVED SUBSTRATE
	→ SEE NOTE(S)

VersiGard COMMON DETAILS (EPDM)

VGC-18.1

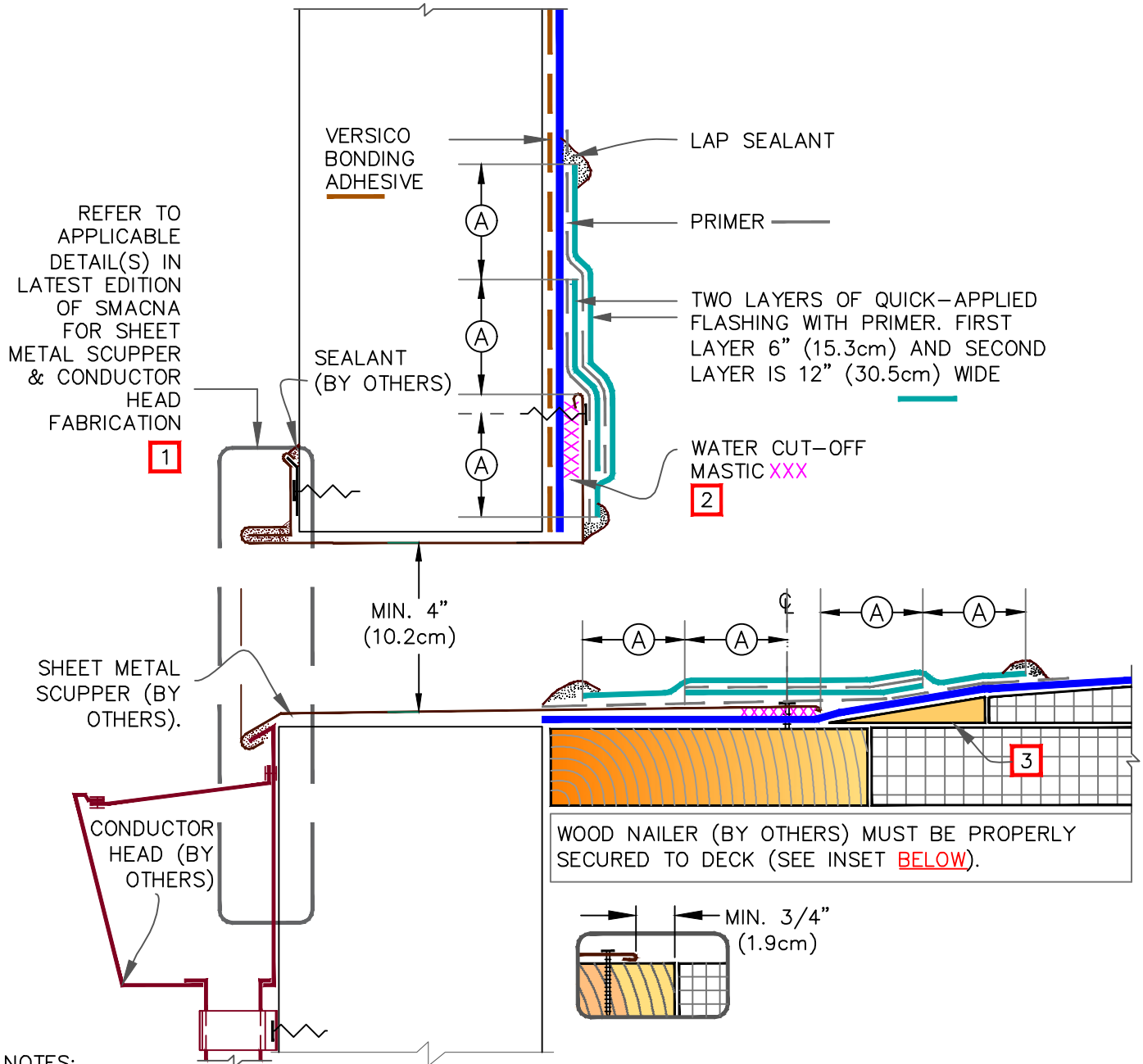

1. METAL SCUPPER BOX MUST HAVE CONTINUOUS FLANGES WITH ROUNDED CORNERS, SOLDER ALL SCUPPER SEAMS AIR & WATER-TIGHT.
2. WATER CUT-OFF MASTIC UNDER SCUPPER FLANGES MUST BE UNDER CONSTANT COMPRESSION.
3. TAPERED EDGE STRIP BY HUNTER OR CANT STRIP, AS REQUIRED & SET IN ADHESIVE OR SHAVE THE EDGES OF TAPERED INSULATION.

DIMENSIONS		cm	
(A)	2"	5	MIN.

MAXIMUM WARRANTY: 30 YEARS



SCUPPER: DOUBLE LAYERS
FLASHING PAGE 1 OF 2

- EPDM MEMBRANE
- APPROVED SUBSTRATE
- SEE NOTE(S)

VersiGard COMMON
DETAILS (EPDM)

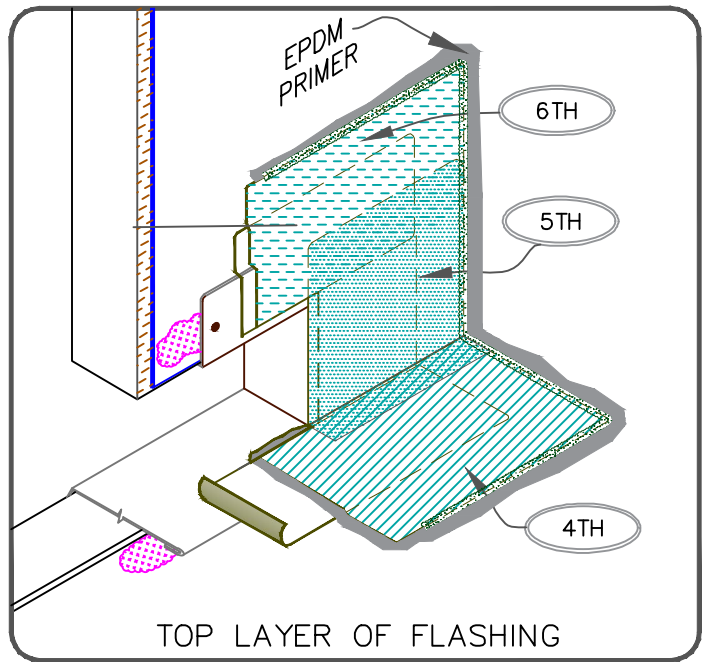
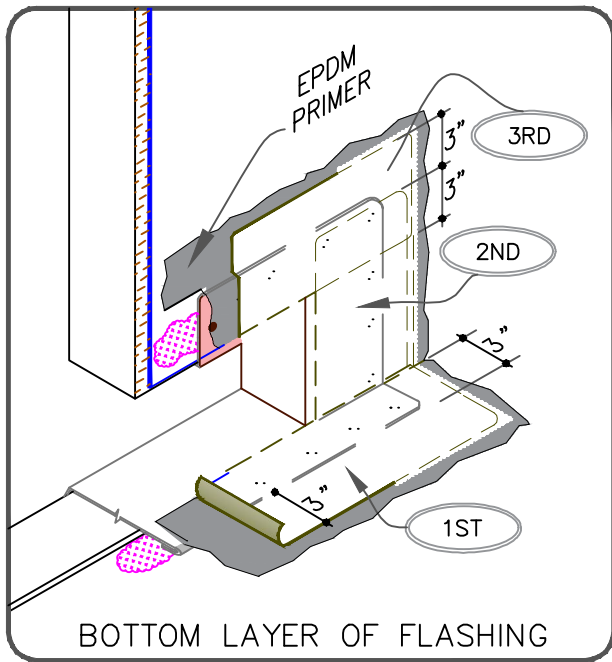
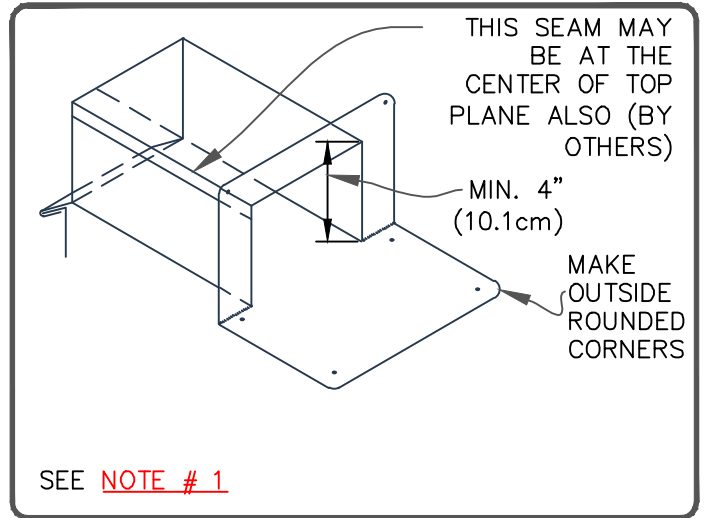
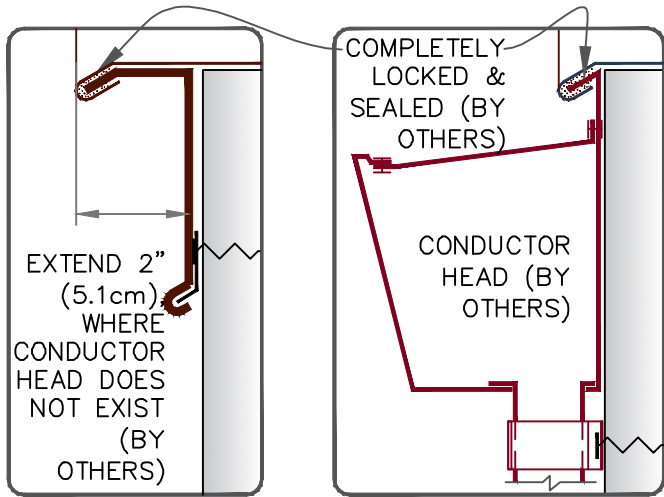

VGC-18.1A



MAXIMUM WARRANTY: 30 YEARS



SCUPPER: DOUBLE LAYERS
FLASHING PAGE 2 OF 2

-  → EPDM MEMBRANE
-  → APPROVED SUBSTRATE
-  → SEE NOTE(S)

VersiGard COMMON
DETAILS (EPDM)

VGC-18.1A

USE APPROPRIATE **VGC-9.0** DETAIL TERMINATION FOR WARRANTY DURATION (ABOVE ANTICIPATED WATER LEVEL OR SLUSH LINE)

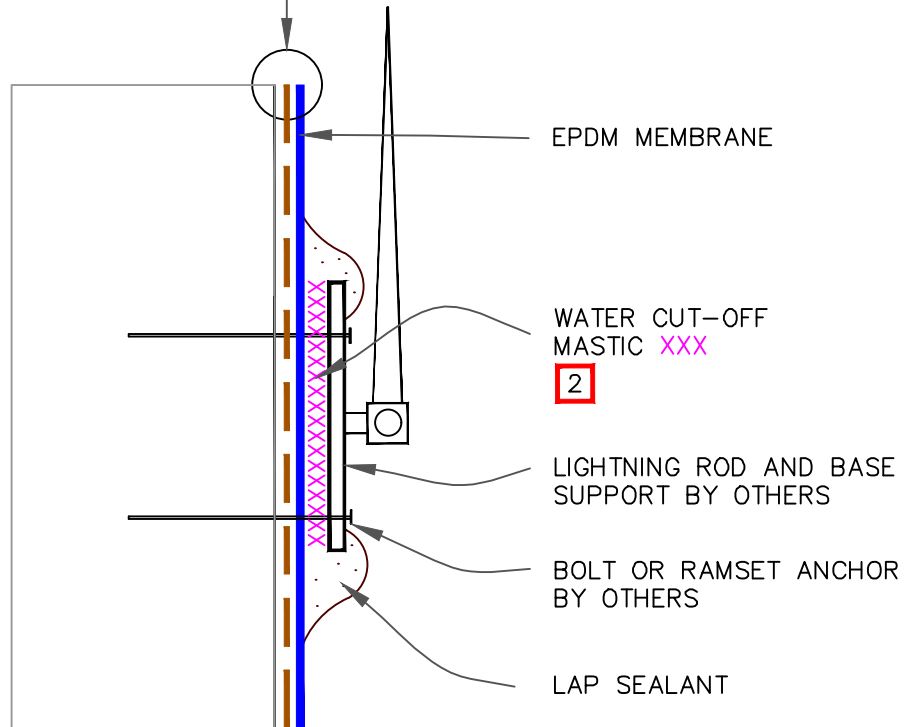



NOTES:

1. DETAIL MAY BE USED FOR ANY FASTENER PENETRATION (E.G., ACCESS LADDER, ANCHOR SUPPORT TO PARAPET).
2. WATER CUT-OFF MASTIC MUST BE UNDER CONSTANT COMPRESSION.
3. COMPLY WITH ZONING ORDNANCE AND LOCAL CODES FOR MOUNTING A LIGHTNING SYSTEM.
4. DETAIL UNACCEPTABLE FOR HORIZONTAL APPLICATIONS ON ROOF DECK.

MAXIMUM WARRANTY: 30 YEARS



LIGHTNING ROD AT PARAPET (VERTICAL ATTACHMENT)

-  → EPDM MEMBRANE
-  → APPROVED SUBSTRATE
-  → SEE NOTE(S)

VersiGard COMMON DETAILS (EPDM)

VGC-20.1

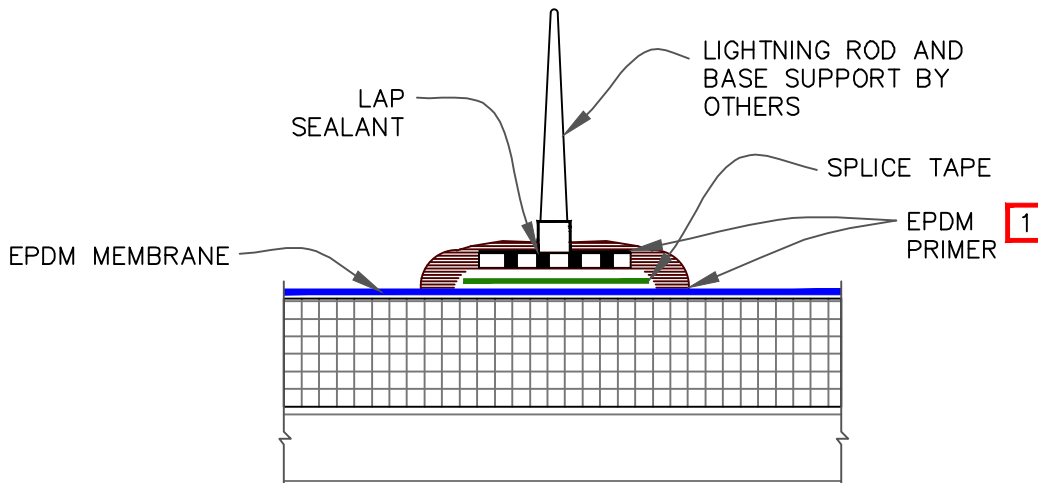
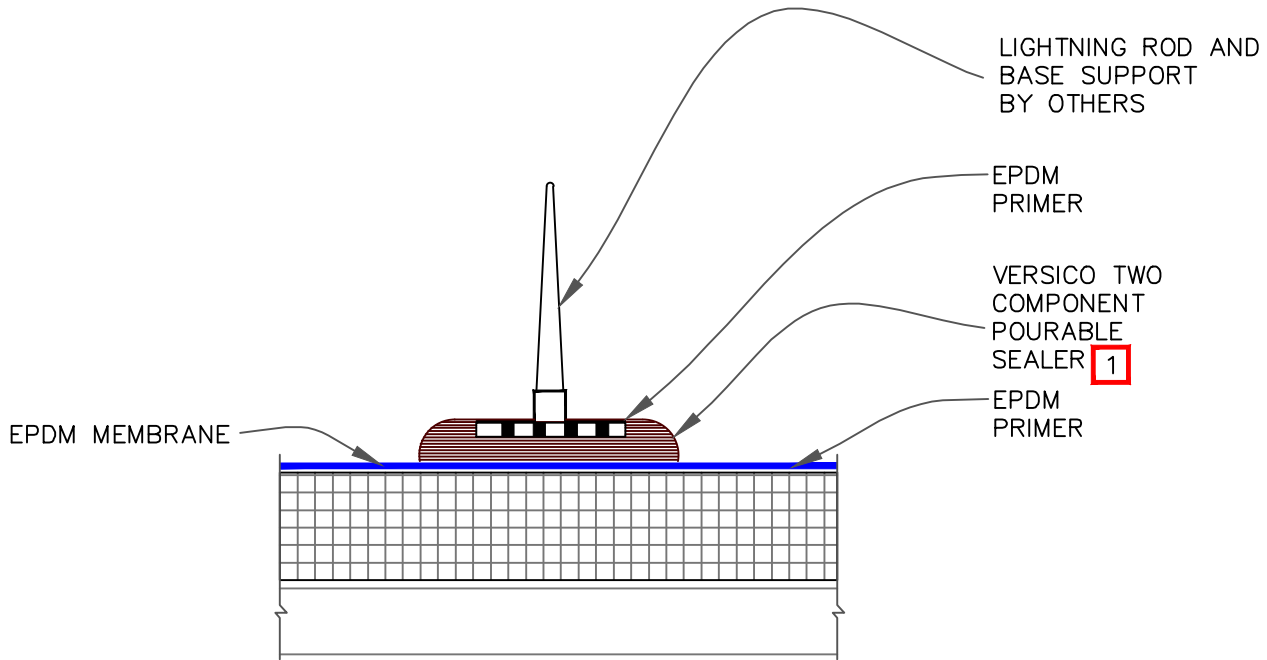



NOTES:

1. VERSICO TWO COMPONENT POURABLE SEALER IN CONJUNCTION WITH EPDM PRIMER, OR UNIVERSAL SINGLE-PLY SEALANT.
2. CLEAN EXPOSED MEMBRANE WITH WEATHERED MEMBRANE CLEANER AND ALLOW TO DRY.
3. PRIOR TO THE APPLICATION OF POURABLE SEALER, APPLY EPDM PRIMER TO THE MEMBRANE AND LIGHTNING ROD BASE ACHIEVING A VERY THIN EVEN COAT ON BOTH SURFACES. ALLOW PRIMER TO DRY UNTIL IT IS TACK FREE.
4. COMPLY WITH ZONING ORDNANCE AND LOCAL CODES FOR MOUNTING A LIGHTNING SYSTEM.

MAXIMUM WARRANTY: 30 YEARS



LIGHTNING ROD AT DECK LEVEL

-  → EPDM MEMBRANE
-  → APPROVED SUBSTRATE
-  → SEE NOTE(S)

VersiGard COMMON DETAILS (EPDM)

VGC-20.2

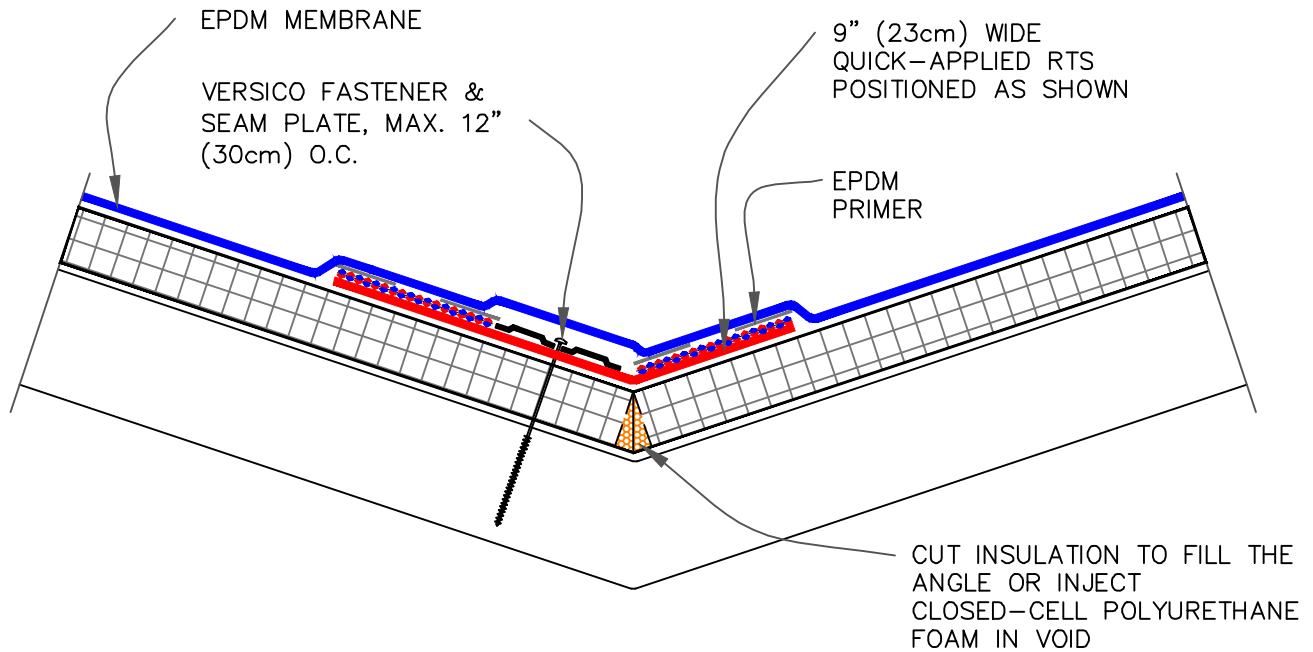



NOTES:

1. DETAIL FOR VERSIGARD/VERSIGARD-WHITE ADHERED AND VERSIGARD MECHANICALLY-ATTACHED ROOFING SYSTEMS WHEN SLOPE AT VALLEY EXCEEDS 2" (5cm) IN ONE HORIZONTAL FOOT.
2. ON MECHANICALLY-ATTACHED ROOFING SYSTEMS, HPV FASTENERS AND POLYMER SEAMS ARE REQUIRED OVER STEEL DECKS.
3. EPDM PRIMER MUST BE APPLIED TO BACK SIDE OF DECK MEMBRANE PRIOR TO COMPLETING SPLICE TO QUICK APPLIED RTS.

MAXIMUM WARRANTY: 30 YEARS



VALLEY

-  → EPDM MEMBRANE
-  → APPROVED SUBSTRATE
-  → SEE NOTE(S)

VersiGard COMMON DETAILS (EPDM)

VGC-22

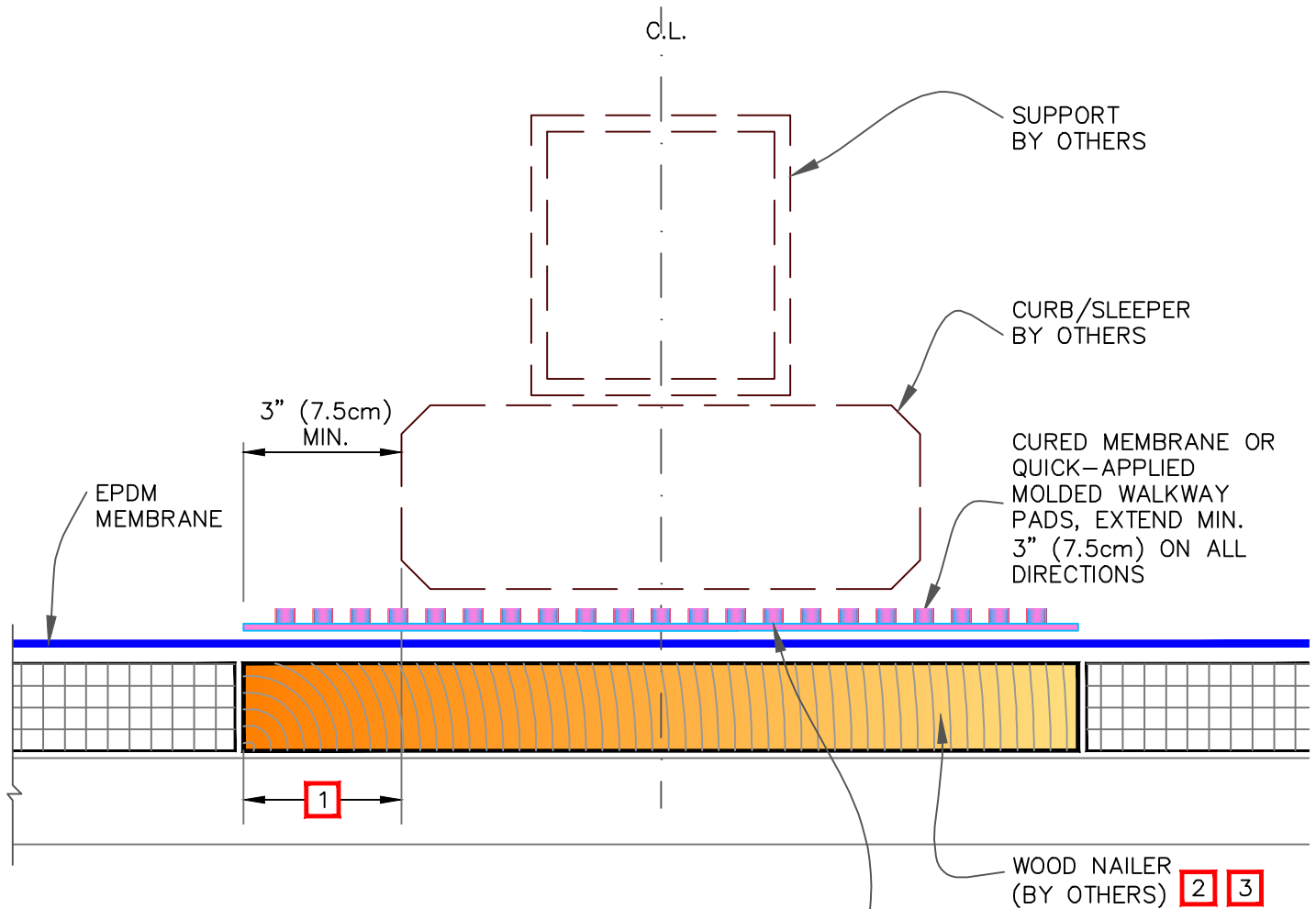

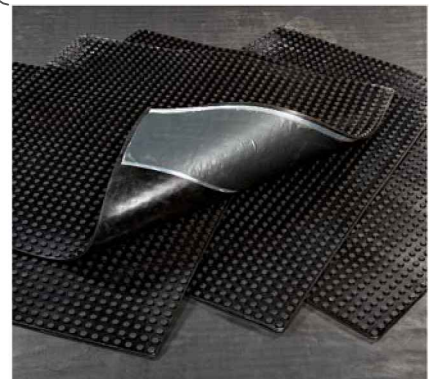

NOTES:

1. SLEEPER MUST BE LARGE ENOUGH TO SUPPORT WEIGHT OF EQUIPMENT WITHOUT INDENTING INSULATION. EXTEND WOOD NAILER OUT AS REQUIRED BY STRUCTURAL ENGINEER TO DISTRIBUTE SUBJECT LOAD OR AT LEAST EXTEND OUT MIN. 3" (7.5cm).
2. ENSURE SCREW/ANCHOR HEADS IN TOP SURFACE OF WOOD BLOCKING ARE RECESSED TO PROTECT MEMBRANE.
3. WOOD NAILERS REQUIRED IF WEIGHT OF SLEEPER MAY INDENT OR DAMAGE INSULATION.
4. CONSULT STRUCTURAL ENGINEER AND/OR SPECIFIER TO AVOID WATER PONDING DUE TO DECK DEFLECTION.



MAXIMUM WARRANTY: 30 YEARS



SLEEPER	 → EPDM MEMBRANE
	 → APPROVED SUBSTRATE
	 → SEE NOTE(S)

VersiGard COMMON DETAILS (EPDM)
VGC-24

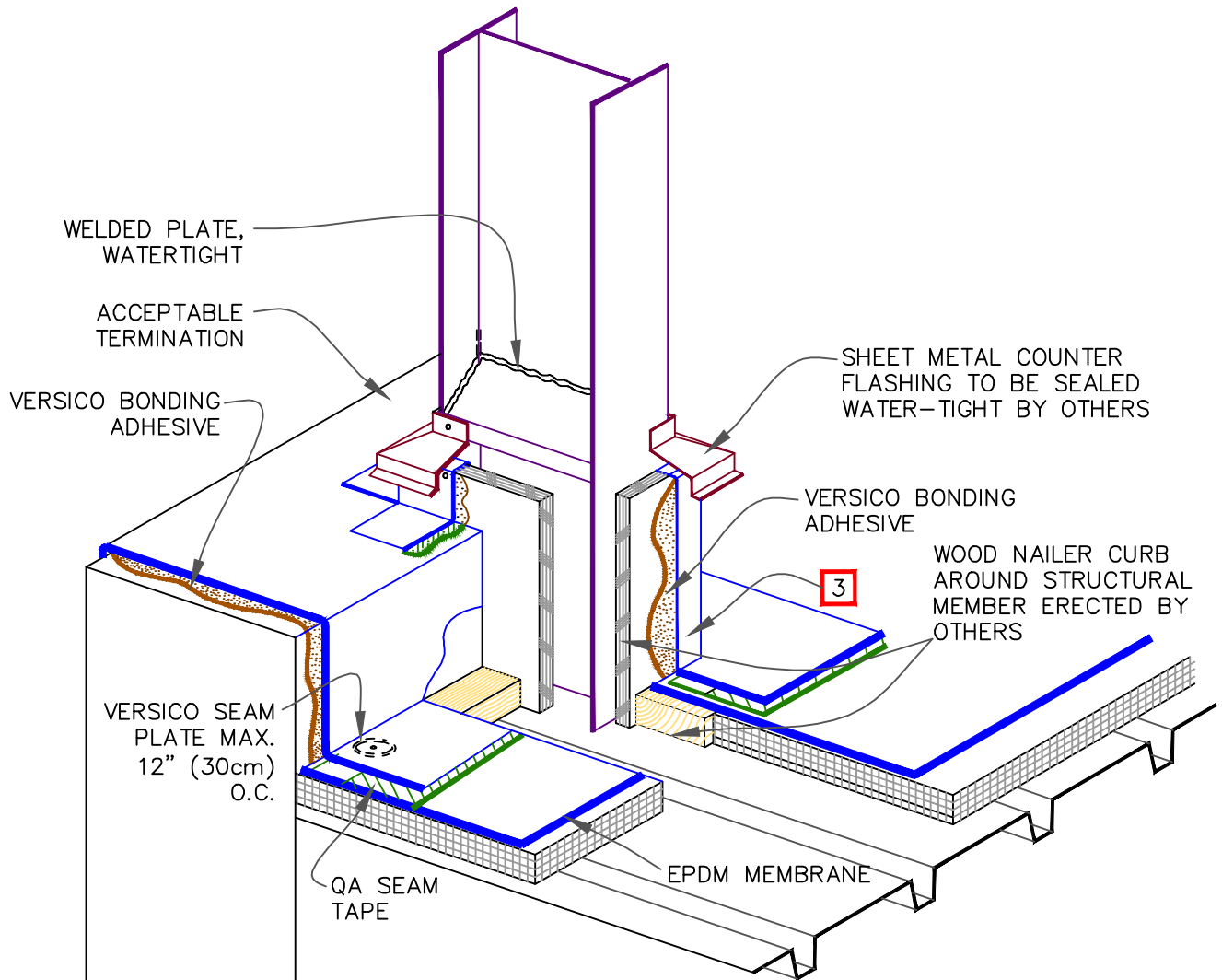



NOTES:

1. FOR PARAPET FLASHING, REFER TO DETAIL(S) [VGC-12.](#)
2. FOR CURB FLASHING, REFER TO DETAIL(S) [VGC-5.](#)
3. FOR CORNER APPLICATION, REFER TO DETAIL(S) [VGC-15.](#)

MAXIMUM WARRANTY: 30 YEARS



I-BEAM PENETRATION

-  → EPDM MEMBRANE
-  → APPROVED SUBSTRATE
-  → SEE NOTE(S)

VersiGard COMMON DETAILS (EPDM)

VGC-30

