



PETITION FOR A SPECIAL PRIVILEGE

ccl-246 (7/15)

SP 2738
CCF 160259

- New application \$250.00 Fee**
- Amendment to add items to Special Privilege # _____ (\$125.00 Fee)**
- Amendment to remove items from Special Privilege # _____ (No fee)**
- Amendment for change of ownership for Special Privilege # _____ (No fee)**

- File petition with the Department of Public Works, Attention: Special Privileges, 841 North Broadway, Room 919, Milwaukee, WI 53202.
- Fee must be submitted with petition. Checks should be made payable to the City of Milwaukee.
- Questions? Call 414-286-2454

To the Honorable, The Common Council of the City of Milwaukee: MEMENTO LLC (LESEE)
 The Licensee 153 NORTH MILWAUKEE, a WI LP (OWNER)
(Name of Individual, Partners, Corporation or LLC)

being the owners of the following property known by street address as 330 E MENDOTA ST.
(Street Address and Zip Code)

in the 4th Aldermanic District respectfully petition the Common Council of the City of Milwaukee according to the provisions of Section 66.0425 of the Wisconsin Statutes, that the following privilege be granted:

Description of Special Privilege: PARKLET

Of which a plan or sketch is herewith submitted. Petitioner agrees to comply with all laws and all ordinances of the City of Milwaukee, to abide by any order or resolution of the Common Council affecting this privilege, to be primarily liable for damages to person or property by reason of the granting of such privilege, pay annual compensation as provided by law in the sum to be fixed by the proper city officers, and to file and keep current throughout the existence of the privilege, a certificate of insurance indicating applicant holds a public liability policy in at least the sums of \$25,000.00/\$50,000.00 bodily injury, and \$10,000.00 property damage, insuring the city against any liability that might arise by reason of the privilege.

Petitioner further agrees to remove said privilege whenever public necessity so requires when so ordered upon resolution adopted by the Common Council or other legislative body.

Should this special privilege be discontinued for any reason whatsoever, petitioner agrees to remove all construction work executed pursuant to this special privilege, to restore to its former condition and to the approval of the Commissioner of Public Works, any curb, pavement, or other public improvement which was removed, changed or disturbed by reason of the granting of this special privilege. Petitioner further agrees not to contest the validity of Section 66.0425 of the Wisconsin Statutes, or the legality of this special privilege in any way.

Name (Please Print): Benjamin La Marlin, Authorized Agent
(Individual, Partner, or Agent if corporation or LLC as shown above)

Signature: [Signature] Date: 5/26/16
(Individual, Partner, or Agent if corporation or LLC)

Corporation or LLC Name: 153 North Milwaukee, LP
(If applicable, as shown above)

Mailing Address (If different than property address above): 157 N. Milwaukee 53202

(OVER)

City: _____ State: _____ Zip: _____

Telephone: _____ E-Mail: _____

Architect/Engineer/Contractor (If Applicable) LESEE

Name: MEMENTO LLC dba BAVETTE

Address: 330 E MENDOTA STREET

City: MILWAUKEE State: WI Zip: 53202

Telephone: 414-273-3375 E-Mail: KAREN@BAVETTEMILWAUKEE.COM

IMPORTANT NOTICE FOR CUSTOMERS PAYING BY CHECK

When you provide a check as payment, you authorize us either to use information from your check to make a one-time electronic fund transfer from your account or to process the payment as a check transaction.



PROPOSED PARKLET

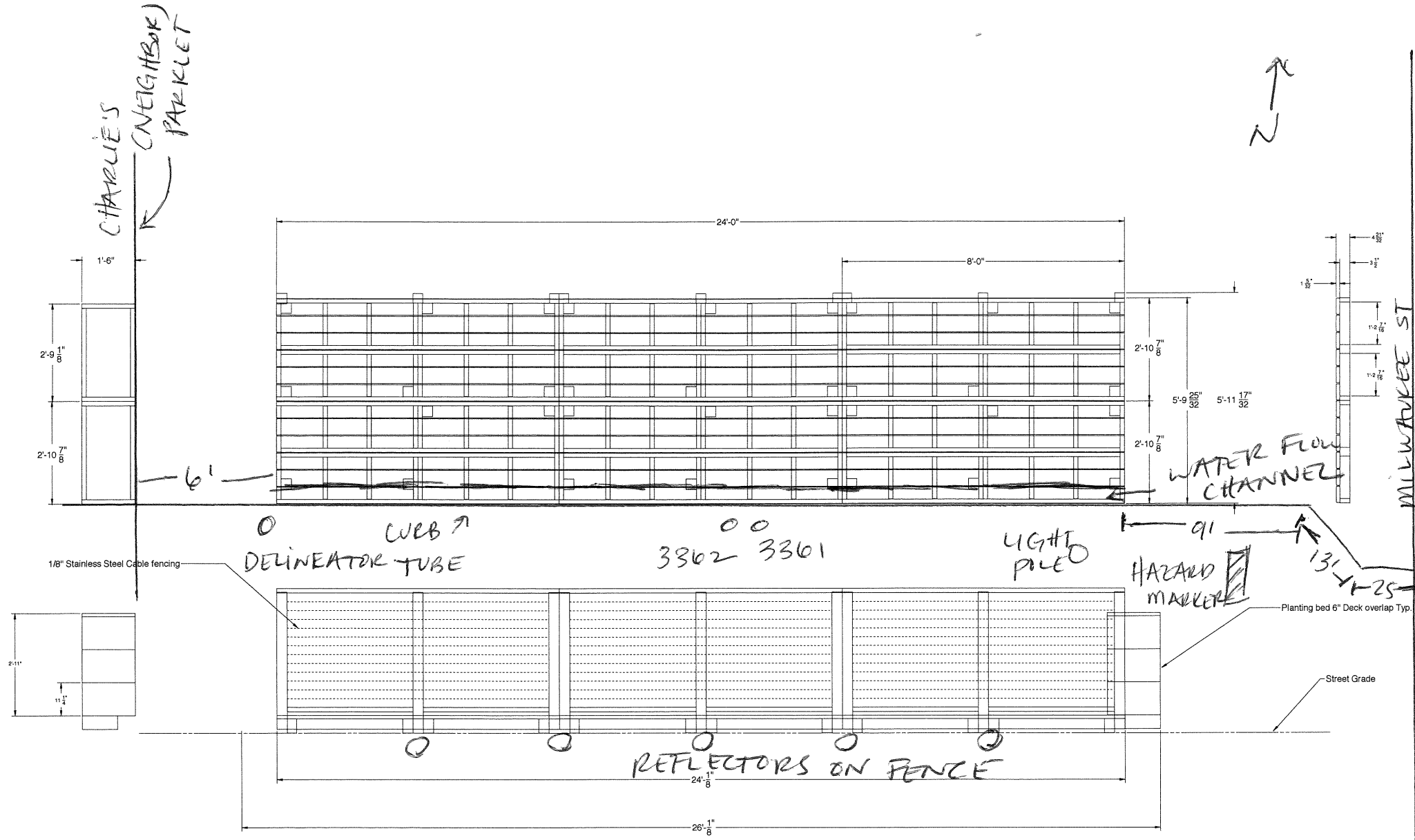

~~XXXXXXXXXXXXXXXXXXXX~~
MOMENTUM dba BAVETTE
330 E MENOMONEE ST.
MAY 25, 2010

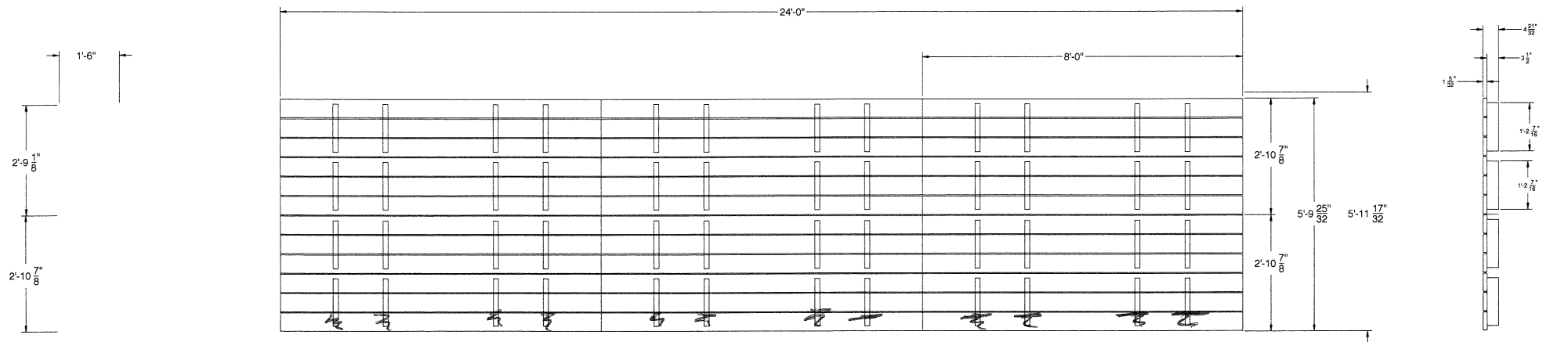

1/8" Stainless Steel Cable fencing

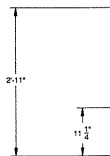

Planting bed 6" Deck overlap Typ.

Street Grade

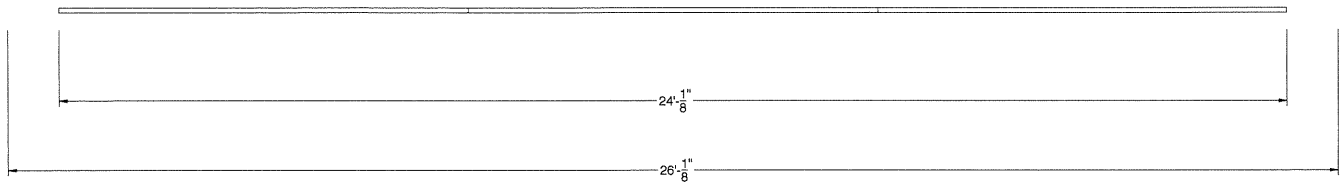

Bavette La Boucherie Parklet *BASE*

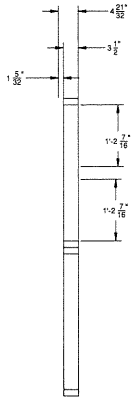
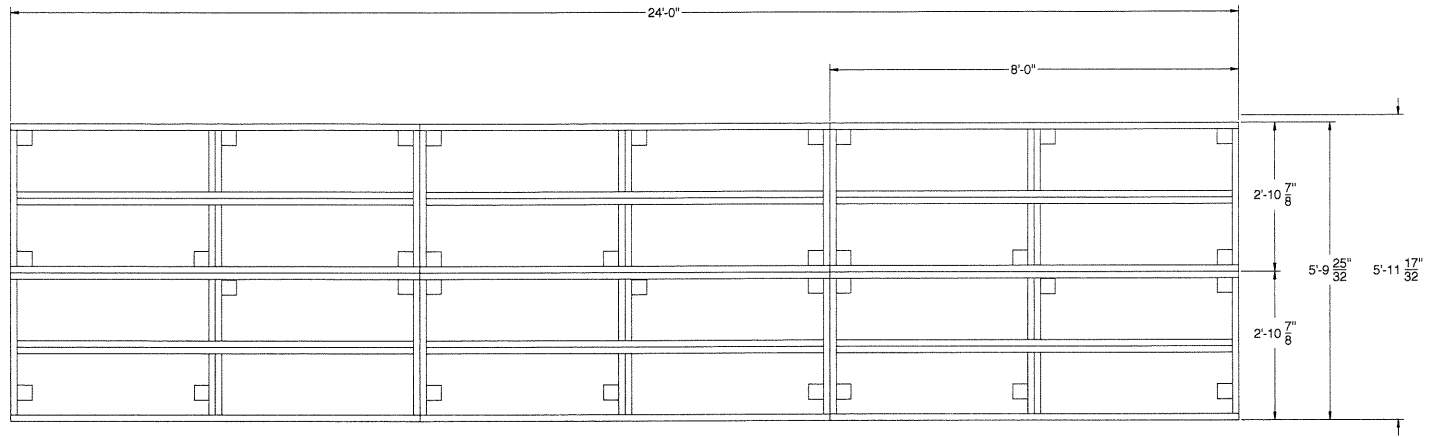
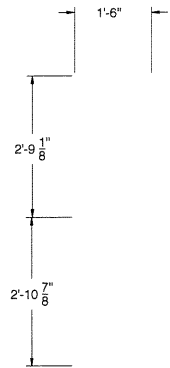

1/8" Stainless Steel Cable fencing

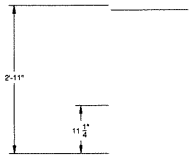

Planting bed 6" Deck overlap Typ.

Street Grade

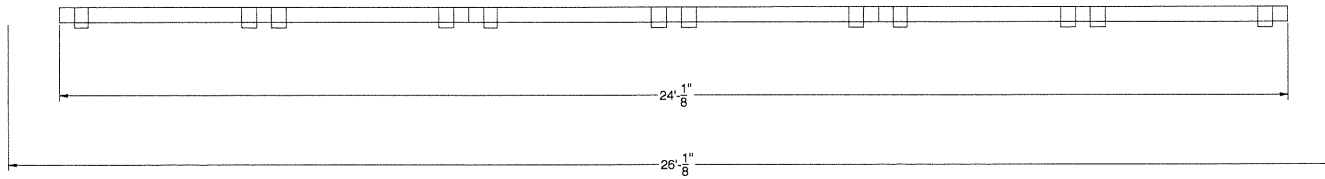

Bavette La Boucherie Parklet *BASE*

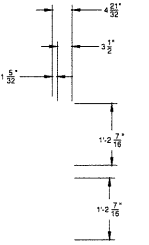
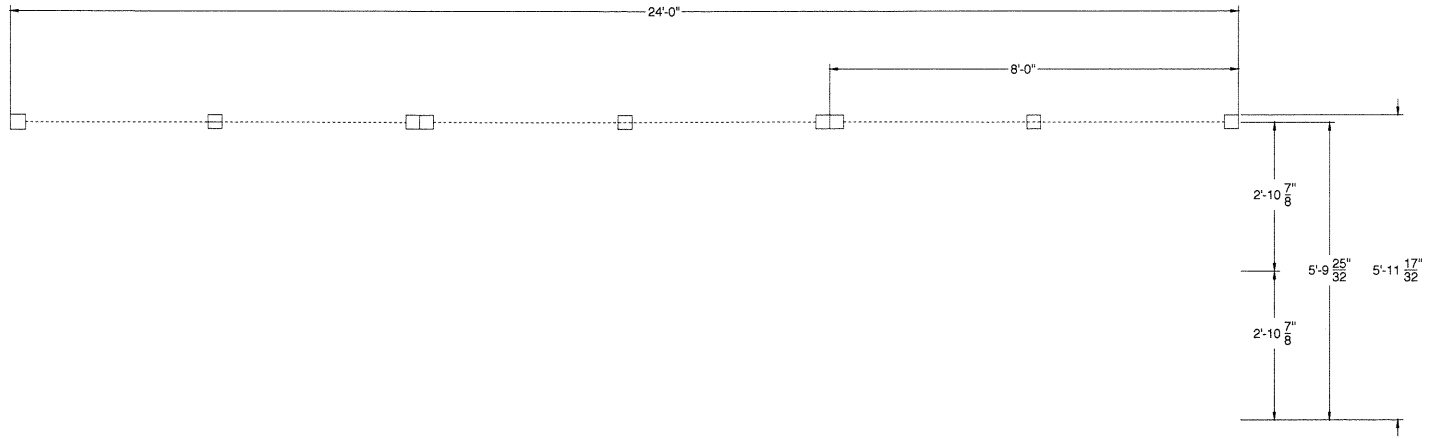
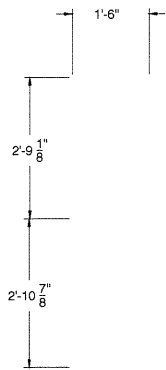

1/8" Stainless Steel Cable fencing

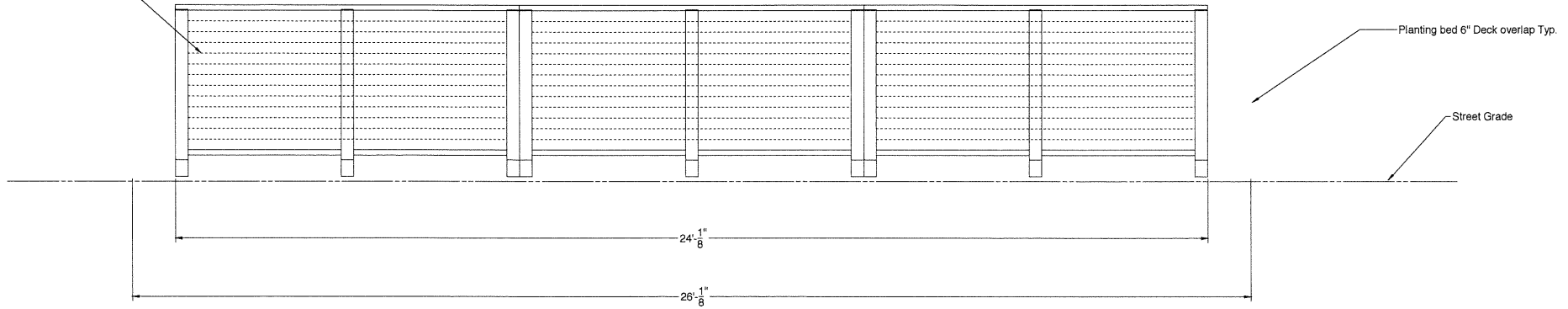
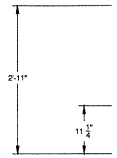

Bavette La Boucherie Parklet *FENCE*

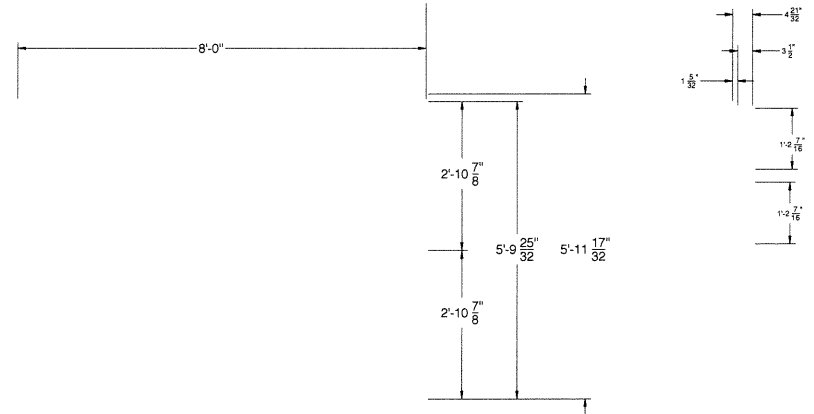
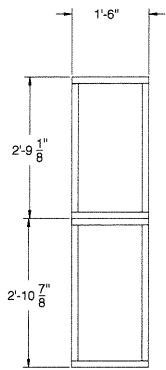

1/8" Stainless Steel Cable fencing

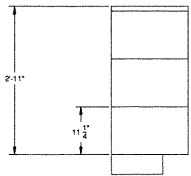

Planting bed 6" Deck overlap Typ.

Street Grade

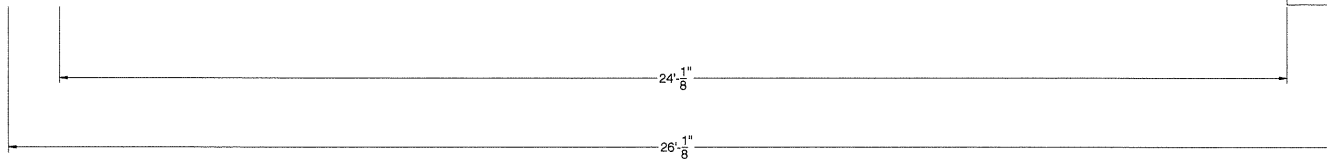

Bavette La Boucherie Parklet *SIDE PLANTERS
ACTING AS FENCE*

Bavette Cut list treated pine									
Type	Price	Qty	Extended	Description	Source				
Framing	\$	214.94							
fence	\$	925.85							
Planter	\$	478.94							
Decking	\$	286.46							
Tools	\$	277.00							
	\$	-							
Not in total	\$	32.97							
Total:	\$	2,183.19							
Framing	\$	4.27	24 \$	102.48	2" x 4" x 8' Lumber uncut	Menards			
Framing	\$	4.27	9 \$	38.43	2" x 4" x 8' Lumber	Menards		96	
Not in total	\$	10.99	3 \$	32.97	2" x 6" x 8' Flat Handrail - Treated pine may warp over time	Menards			
fence	\$	9.99	9 \$	89.91	4" x 4" x 48" AC2® CedarTone Premium Pressure	Menards			
Decking	\$	2.37	8 \$	18.96	2" x 4" x 8' Lumber decking support	Menards			
Decking	\$	6.32	36 \$	227.52	8' AC2® CedarTone Premium Pressure Treated Decking	Menards	14.4375	6.6493506	92.0625
fence	\$	59.95	4 \$	239.80	VistaView Stainless Steel Hand-Crimp Lag Stud for 1/8" Cable Railing (Lot of 10)	Amazon	19.875	4.8301886	5
fence	\$	67.50	4 \$	270.00	VistaView Stainless Steel Hand-Crimp Threaded Terminals for 1/8" Cable Railing (Lot of 10)	Amazon			2
fence	\$	88.14	1 \$	88.14	1/8" X 200', 7x19, Grade 304 Vinyl Coated Stainless Steel Cable Reel	Amazon			
Framing	\$	8.99	3 \$	26.97	4" x 4" x 8' Pressure Treated Pine Lumber- Ground	Menards		96	
Planter	\$	45.79	6 \$	274.74	2" x 12" x 8' Red Cedar Lumber	Menards			
Planter	\$	20.42	10 \$	204.20	2" x 12" x 8' AC2® CedarTone Premium Pressure Treated GC Lumber	Menards			
fence	\$	6.49	3 \$	19.47	2" x 4" x 8' AC2® CedarTone Premium Pressure Treated GC Lumber	Menards			
Decking	\$	39.98	1 \$	39.98	KREG SDK-C2W-700 2-Inch, #8 Coarse, Deck Screw, 700 Ct	Amazon			16
Framing	\$	6.97	1 \$	6.97	Crown Bolt 30042 3/8 Inch Zinc-Plated SAE Flat Washers, 50-Count	Amazon			
Framing	\$	9.09	1 \$	9.09	The Hillman Group 150009 Finish Hex Nut, 3/8-Inch by 16-Inch, 100-Pack	Amazon			
Framing	\$	24.46	1 \$	24.46	The Hillman Group 240183 Carriage Bolt, 3/8-Inch X 4-1/2-Inch, 50-Pack	Amazon			
Framing	\$	6.54	1 \$	6.54	The Hillman Group 300024 Split lock Zinc Washer, 3/8-Inch, 100-Pack	Amazon			
fence	\$	2.99	2 \$	5.98	Grip Fast 5/16" x 4" Zinc-Plated Lag Screws (14 Pieces)	Menards			
fence	\$	70.85	3 \$	212.55	Mr. Spindle Configured 2" x 6" x 96" Handrail- Cedar	Menards			
Tools	\$	79.00	1 \$	79.00	KREG KJDECKSYS Deck Jig	Amazon			
Tools	\$	198.00	1 \$	198.00	22" Hand Swager Crimper for 1/8" , 3/16" Stainless Steel Cable Fittings	Amazon			
	\$	-							
	\$	-							
	\$	-							
	\$	-							
	\$	-							
	\$	-							
	\$	-							
	\$	-							
	\$	-							

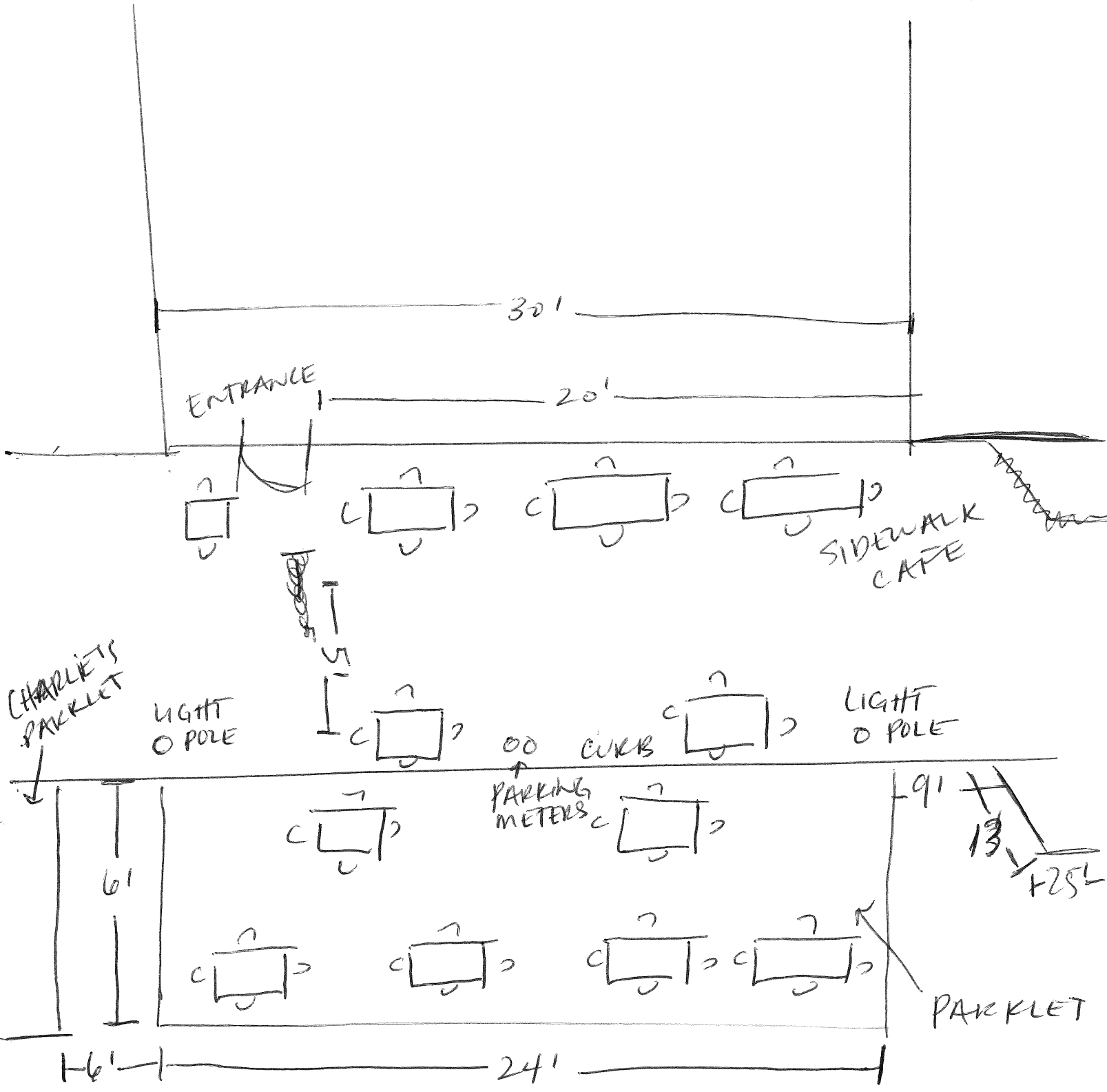

MEMENTO LLC dba BAVETTE
 330 E MEMORONTEE ST.
 MAY 25, 2014

