

PROJECT NOTES

A. APPLICABLE CODES

- CONSTRUCTION & MATERIALS: CONFORM WITH THE FOLLOWING REGULATORY REQUIREMENTS.
 PRIMARY BUILDING CODE: INTERNATIONAL BUILDING CODE, 2015 AS WELL AS THE INTERNATIONAL EXISTING BUILDING CODE, 2015
 FIRE PREVENTION: INTERNATIONAL BUILDING CODE, 2015, AND THE NATIONAL FIRE CODE (NFPA).
 ACCESSIBILITY: INTERNATIONAL BUILDING CODE, 2015, ANSI A117.1, 2009 VERSION.
- HISTORIC STATUS
 THE GERMANIA BUILDING WAS LISTED IN THE NATIONAL REGISTER OF HISTORIC PLACES ON JULY 7, 1983.
 THE GERMANIA BUILDING WAS GRANTED HISTORIC DESIGNATION BY THE CITY OF MILWAUKEE HISTORIC PRESERVATION COMMISSION.
- IEBC BUILDING DATA
 LEVEL 2 ALTERATION PER IEBC
 WORK AREA = STOREFRONT REPLACEMENT AT BUILDING ENTRY
- BUILDING DATA
 OCCUPANCY CLASSIFICATION: R-2 AND S-2
 CONSTRUCTION TYPE: TYPE IB
 SPRINKLERED: NFPA - 13 THROUGHOUT BUILDING
 NUMBER OF STORIES: 11 - ALLOWED; BUILDING IS 8 STORIES
 BUILDING HEIGHT: 110', 160'-4" ALLOWED PER 504.2
 ALLOWABLE AREA PER FLOOR AT R2 OCCUPANCY (TYPE IB) = UNLIMITED (UL)
 ALLOWABLE AREA AT S2 OCCUPANCY (TYPE IB) = 70,000 SF

B. EXISTING CONDITIONS

- THE OWNER WILL MAKE AVAILABLE A SURVEY OF THE SITE, EXISTING UTILITIES AND EXISTING CONSTRUCTION. THE SURVEY REPRESENTS ALL CONDITIONS KNOWN TO THE OWNER. OTHER CONSTRUCTION, OF WHICH NO RECORDS ARE AVAILABLE, MAY BE ENCOUNTERED. THE CONTRACTOR SHALL FURNISH HIS OWN CONCLUSIONS AS TO THE EXTENT OF SUCH CONSTRUCTION, AND SHALL NOTIFY THE OWNER AND THE ARCHITECT IMMEDIATELY IF THE SURVEY APPEARS TO BE AT VARIANCE WITH THE ACTUAL CONDITIONS ENCOUNTERED.
- THE CONTRACTOR SHALL VISIT THE SITE AND BE KNOWLEDGEABLE OF CONDITIONS THEREON. THE CONTRACTOR SHALL INVESTIGATE, VERIFY AND BE RESPONSIBLE FOR ALL CONDITIONS OF THE PROJECT AND SHALL NOTIFY THE ARCHITECT OF ANY CONDITIONS REQUIRING MODIFICATION BEFORE PROCEEDING WITH THE WORK.
- THE CONTRACTOR IS RESPONSIBLE FOR PROPERLY LAYING OUT THE WORK AND FOR ALL LINES AND MEASUREMENTS FOR THE WORK.
- DETAILS SHOWN ARE INDICATIVE OF THE CHARACTER, PROFILES, MATERIALS AND SYSTEMS REQUIRED FOR THE WORK INCLUDING THOSE CONDITIONS NOT COVERED BY SPECIFIC DETAILS.
- WHERE THE DESIGN INTENT CANNOT BE DETERMINED FROM THE DRAWINGS OR SPECIFICATIONS, CONSULT THE ARCHITECT BEFORE PROCEEDING WITH THE WORK.

C. DIMENSIONING

- DIMENSIONS SHALL GOVERN, DO NOT SCALE DRAWINGS. WHERE THERE APPEARS TO BE A CONFLICT BETWEEN DIMENSIONS OR WHERE DIMENSIONS CANNOT BE DETERMINED FROM THE DRAWINGS, CONSULT THE ARCHITECT BEFORE PROCEEDING WITH THE WORK.
- THE CONTRACTOR SHALL VERIFY THE DIMENSIONS SHOWN ON THE DRAWINGS BEFORE LAYING OUT THE WORK, AND SHALL BE HELD RESPONSIBLE FOR ANY ERRORS OR INACCURACIES RESULTING FROM HIS FAILURE TO DO SO. THE CONTRACTOR SHALL NOTIFY THE ARCHITECT OF ANY DISCREPANCIES BETWEEN THE DRAWINGS AND THE SITE CONDITIONS ENCOUNTERED.

D. DESIGN BUILD NOTES

- ELECTRICAL & LOW VOLTAGE: THE ELECTRICAL AND LOW VOLTAGE SCOPE IS TO BE PERFORMED AS A 'DESIGN-BUILD' ARRANGEMENT. MEANING THE ELECTRICAL CONTRACTOR IS THE ENGINEER OF RECORD FOR THEIR RELATED SCOPE OF WORK. THE INFORMATION OUTLINED ON BOTH THE REFLECTED CEILING PLAN AND FURNITURE PLAN ARE FOR REFERENCE ONLY AND OUTLINE THE DESIGN INTENT OF THE TENANT. THE RESPONSIBILITY TO PROVIDE CODE COMPLIANT ELECTRICAL AND LOW VOLTAGE DESIGN IS THE RESPONSIBILITY OF THE ELECTRICAL CONTRACTOR. THE RESPONSIBILITIES OF THE CONTRACTOR INCLUDE BUT ARE NOT LIMITED TO THE FOLLOWING:
 - DRAWINGS THAT OUTLINE DESIGN
 - SUBMITTAL FOR REVIEW BY THE BUILDING OPERATOR AND TENANT
 - NEW EQUIPMENT SHOULD MATCH EXISTING PRODUCTS WHERE POSSIBLE
 - REVIEWS, SUBMITTALS AND REVIEW FEES AS REQUIRED TO THE AUTHORITIES HAVING JURISDICTION
 - COORDINATION WITH PROJECT TEAM
 - MATERIAL AND PRODUCT SUBMITTALS TO BE REVIEWED BY THE GENERAL CONTRACTOR, BUILDING MANAGER AND ARCHITECT
- FIRE PROTECTION AND FIRE ALARM: THE FIRE PROTECTION AND FIRE ALARM SYSTEM MODIFICATIONS ARE TO BE PERFORMED AS A 'DESIGN-BUILD' ARRANGEMENT. MEANING THE CONTRACTOR IS THE ENGINEER OF RECORD FOR THEIR RELATED SCOPE OF WORK. THE INFORMATION OUTLINED ON THE REFLECTED CEILING PLAN OUTLINES THE DESIGN INTENT. THE RESPONSIBILITIES OF THE CONTRACTOR INCLUDE BUT ARE NOT LIMITED TO THE FOLLOWING:
 - DRAWINGS THAT OUTLINE DESIGN
 - NEW EQUIPMENT SHOULD MATCH EXISTING PRODUCTS WHERE POSSIBLE
 - SUBMITTAL FOR REVIEW BY THE BUILDING OPERATOR AND TENANT
 - REVIEWS, SUBMITTALS AND REVIEW FEES AS REQUIRED TO THE AUTHORITIES HAVING JURISDICTION
 - COORDINATION WITH PROJECT TEAM
 - MATERIAL AND PRODUCT SUBMITTALS TO BE REVIEWED BY THE GENERAL CONTRACTOR, BUILDING MANAGER AND ARCHITECT

GENERAL NOTES:

- PERMITS: ALL SELECTED CONTRACTORS ARE REQUIRED TO HOLD VALID PERMITS PRIOR TO COMMENCING WITH WORK OUTLINED.
- EGRESS: CONTRACTOR SHALL MAINTAIN REQUIRED PATHS OF EGRESS FROM OCCUPIED AREA OF EXISTING BUILDING.
- NOISE AND DUST CONTROL: CONTRACTOR TO PROVIDE NOISE AND DUST CONTROL IN BUILDINGS WHERE OCCUPANTS ARE ADJACENT TO THE PROJECT AREA.
- DASHED LINES INDICATE ELEMENTS SCHEDULED FOR DEMOLITION.
- COORDINATE ALL SERVICE INTERRUPTIONS WITH OWNER AND UTILITIES.
- DEMO DRAWINGS ARE BASED ON ORIGINAL DESIGN DRAWINGS AND FIELD OBSERVATIONS. ALL LOCATIONS SHOWN ARE APPROXIMATE. VERIFY EXACT DIMENSIONS IN FIELD.
- CONTRACTOR SHALL PRESERVE AND PROTECT ALL EXISTING BUILDING AMENITIES NOT SLATED FOR DEMOLITION OR REMODELING.
- PATCH, REPAIR AND PAINT EXISTING FINISHES AS REQUIRED AT SELECTED DEMOLITION TO MATCH NEW FINISHES TYPICAL.
- BUILDING ITEMS THAT ARE IN GOOD CONDITION SUCH AS: DOORS, DOOR HARDWARE, LIGHT FIXTURES ETC. SHALL BE RETURNED TO THE BUILDING OWNER OR RE-USED AS SCHEDULED.
- TELEDATA: COORDINATE WITH TENANT AND/OR BUILDING OWNER. ELECTRICAL CONTRACTOR IS RESPONSIBLE FOR RACEWAYS AND WIRING. TENANT OR OWNER IS RESPONSIBLE FOR COORDINATION OF TELEDATA SERVICE SCHEDULING.
- EQUIPMENT: FURNISHED BY OWNER AND INSTALLED BY CONTRACTOR UNLESS NOTED.
- GLASS SPECIFICATION: ALL GLASS TO BE CLEAR AND UN-TINTED TO MEET THE SECRETARY OF THE INTERIOR'S STANDARDS FOR REHABILITATION. BASIS OF DESIGN: SOLARBAN 60 STAFFIRE ULTRA-CLEAR GLAZING LOW-E. ALTERNATES TO BE PROPOSED TO ARCHITECT PRIOR TO INSTALLATION.

LEGEND:

- DOORS & FRAMES TO BE REMOVED
- EXISTING WALL TO REMAIN
- NEW DOOR AND FRAME
- NORTH ARROW

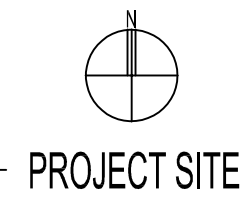
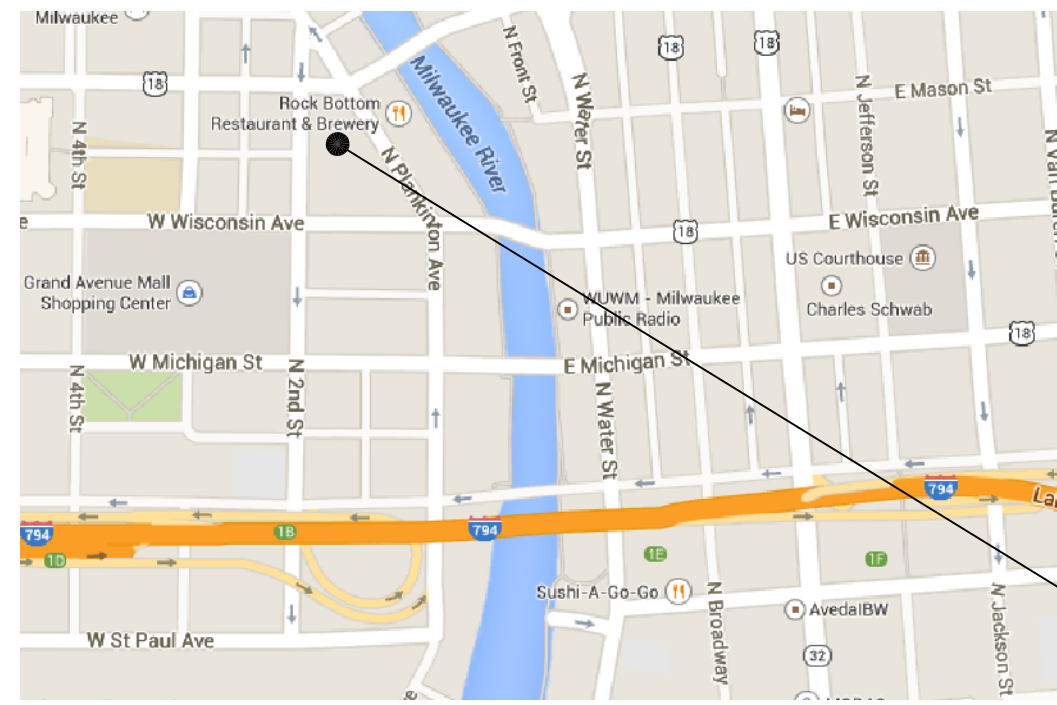

PROJECT SITE

APPROVED
By Tim Askin-HPC at 2:43 pm, Feb 17, 2022

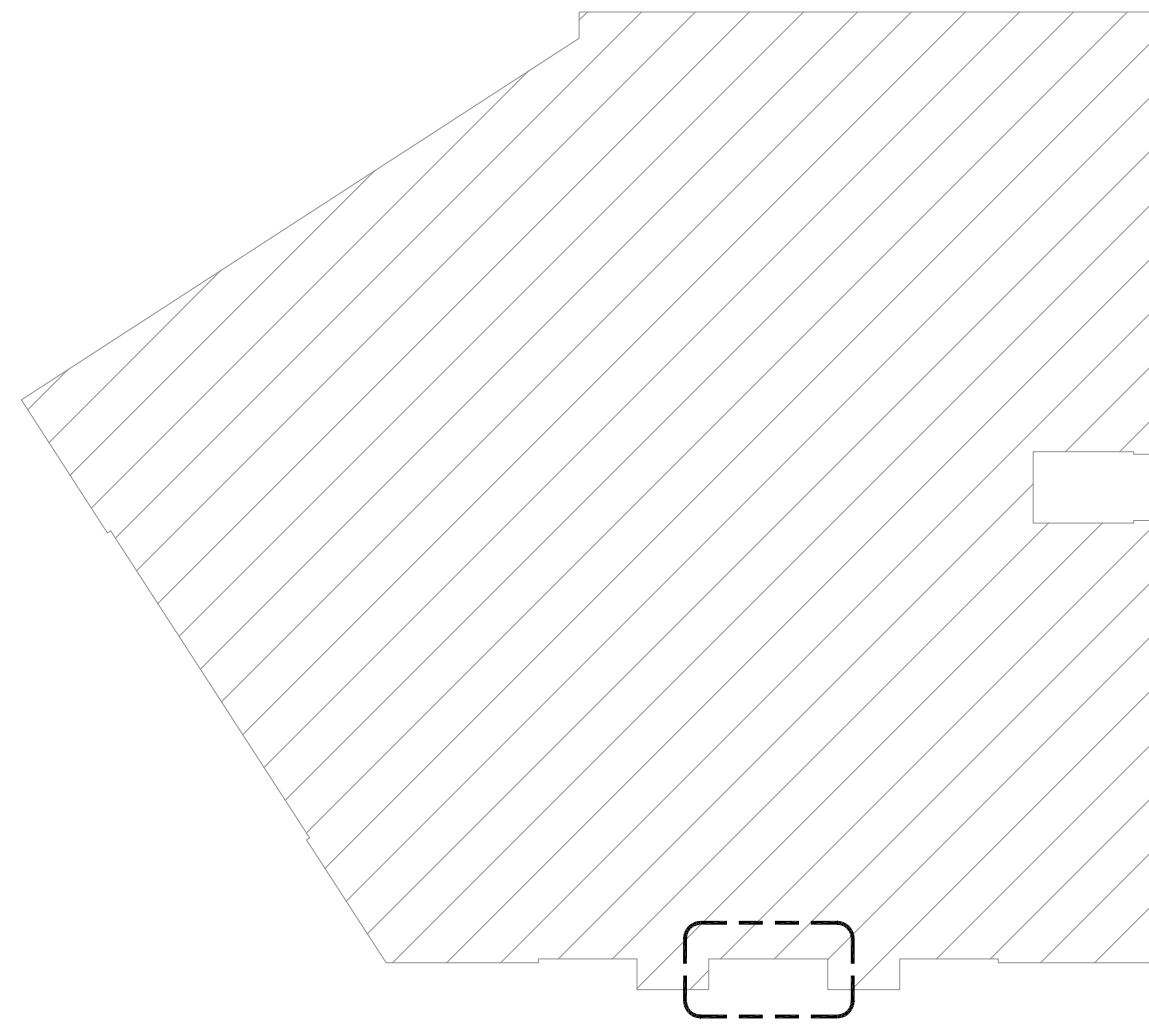

7 AREA OF WORK
NTS

DOOR AND FRAME NOTES:

- ALL DOOR HARDWARE TO MEET ADA REQUIREMENTS.
- DOORS AND FRAMES TO HAVE PAINTED OR BAKED ON FINISH (NOT ANODIZED FINISH) TO MEET THE SECRETARY OF THE INTERIOR'S STANDARDS FOR REHABILITATION. COLOR: DARK BONZE - VERIFY FINAL COLOR SELECTION WITH ARCHITECT.
- SALVAGE EXISTING PULLS WITH THE GERMANIA MOTIF. SELECT BEST QUALITY PULLS FOR CLEANING AND REUSE AT THE EXTERIOR OF THE BUILDING. TURN OVER REMAINING PULLS TO OWNER. COORDINATE NEW PULL STYLE WITH ARCHITECT IF REUSE IS NOT POSSIBLE.
- SALVAGE KEY FOB AND MAG LOCKS FOR REINSTALLATION.
- ALL LOW VOLTAGE WIRING AND DOOR OPERATORS TO BE COORDINATED WITH OWNER.
- HARDWARE GROUP
 - CONTINUOUS HINGES
 - PULLS
 - PANIC DEVICE
 - CYLINDER
 - CLOSER
 - OVERHEAD STOP
 - SEAL
 - SWEEP THRESHOLD

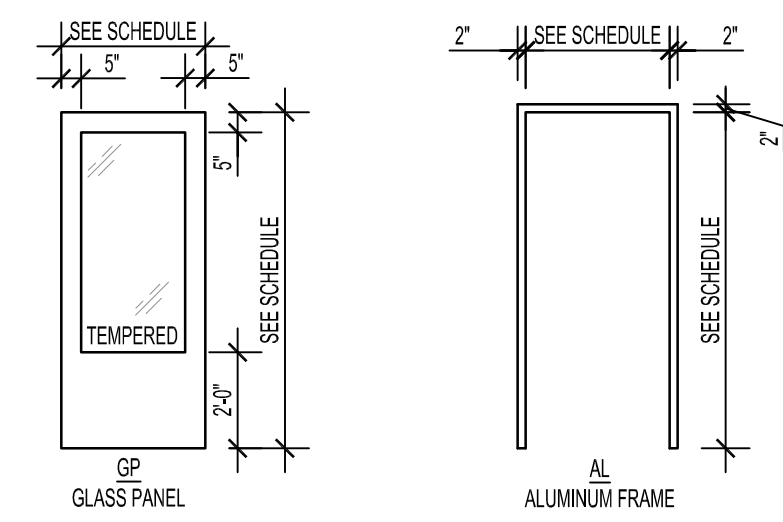

6 DOOR AND FRAME ELEVATIONS
1/4" = 1'-0"

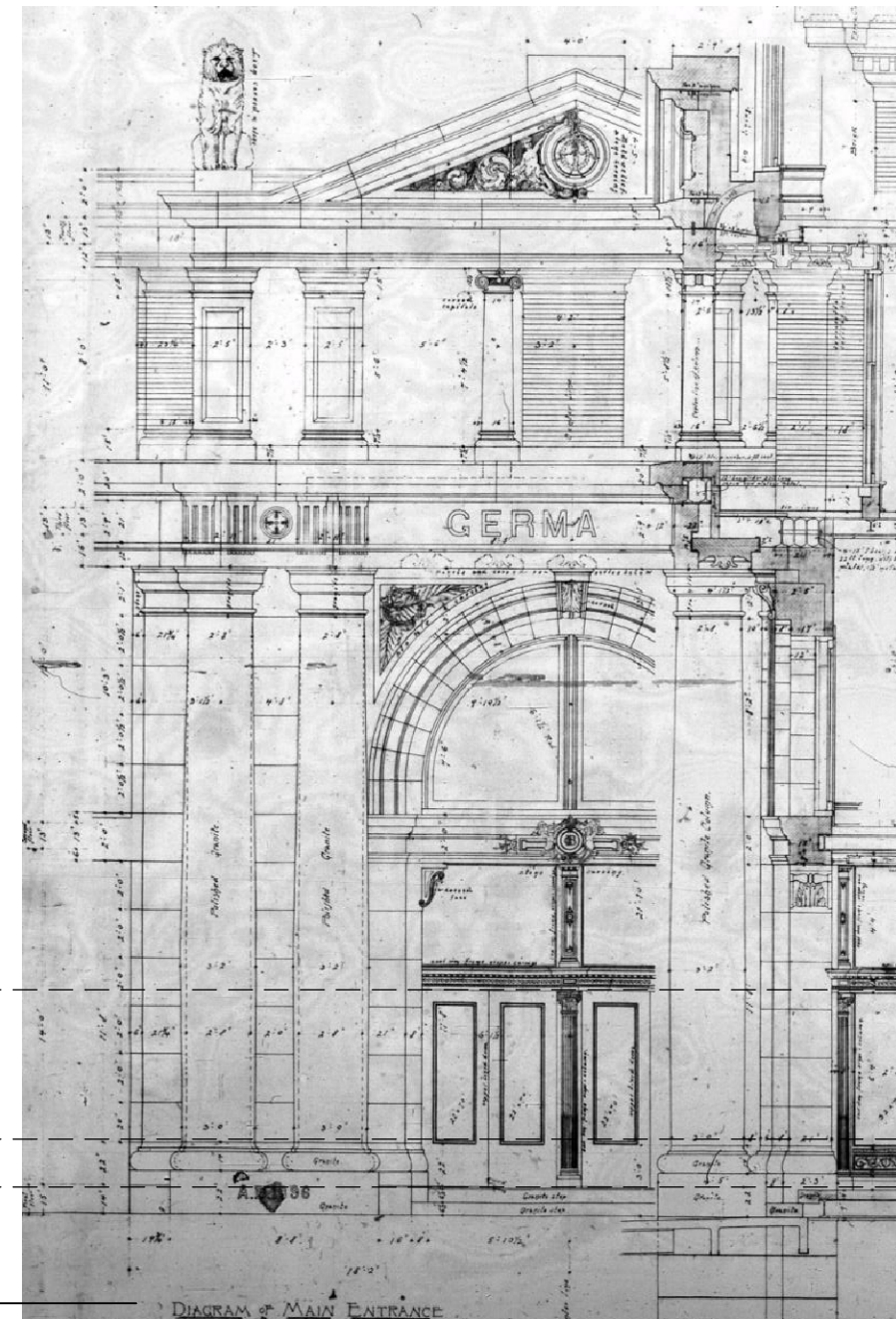

5 PARTIAL NORTH ELEVATION - ORIGINAL DRAWINGS
1/8" = 1'-0"



4 PARTIAL NORTH ELEVATION - DEMOLITION
1/8" = 1'-0"

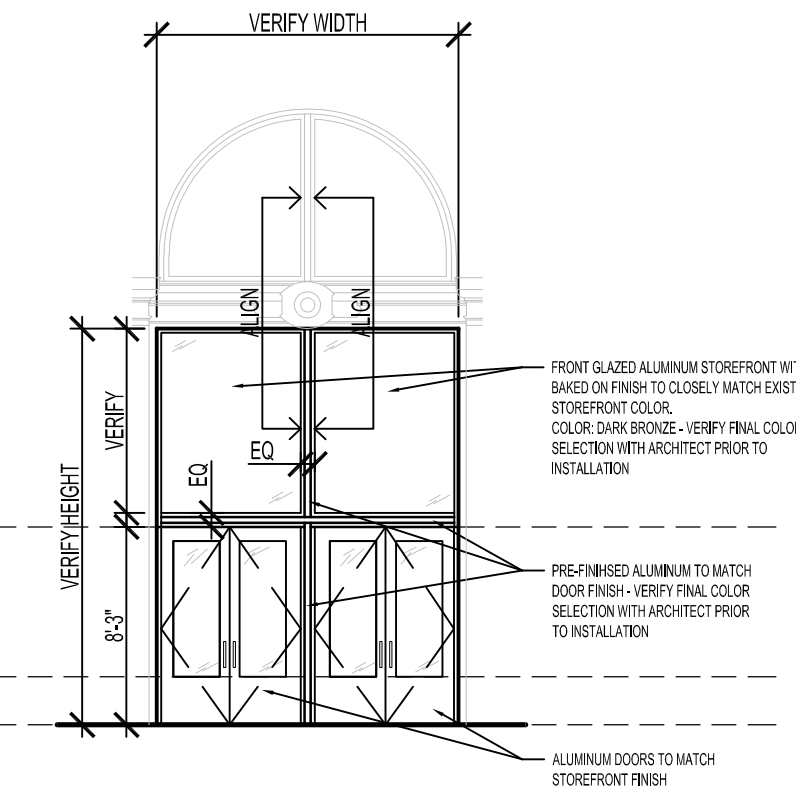

3 PARTIAL NORTH ELEVATION - NEW WORK
1/8" = 1'-0"

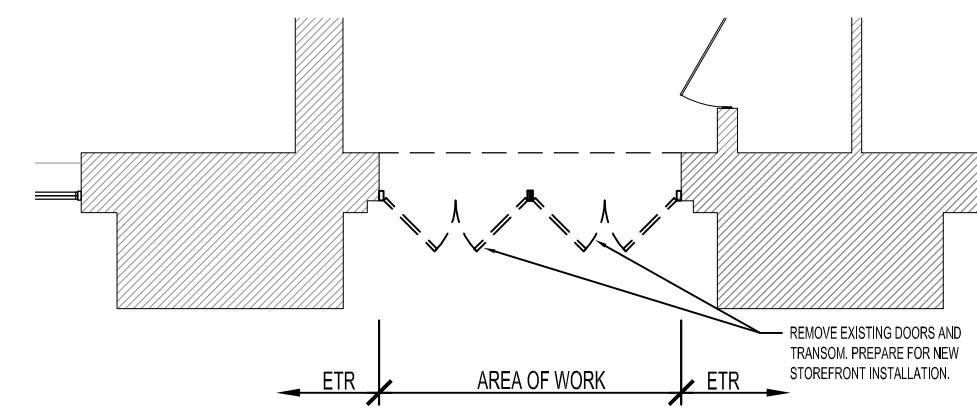

2 PARTIAL FIRST FLOOR DEMOLITION PLAN
1/8" = 1'-0"

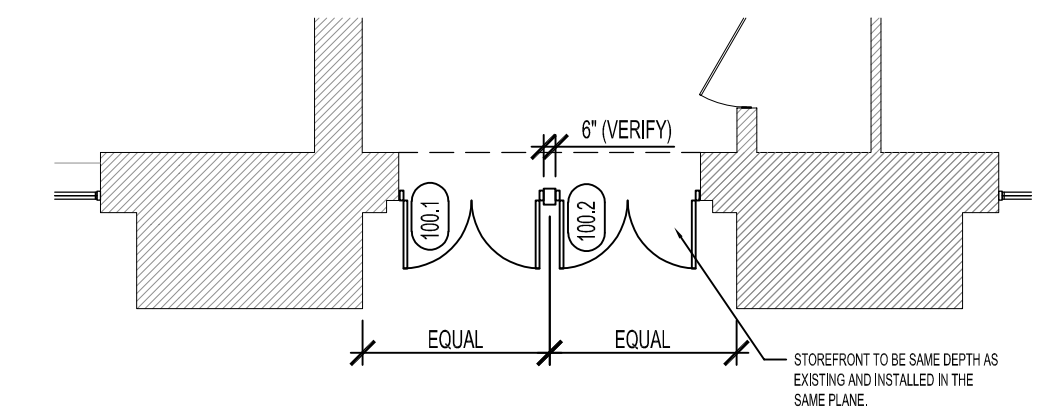

1 PARTIAL FIRST FLOOR NEW PLAN
1/8" = 1'-0"

DOOR AND FRAME SCHEDULE

Type Mark	NUMBER OF PANELS	DOORS					FRAMES			FIRE RATING	HARDWARE GROUP	REMARKS	
		PANEL A WIDTH	PANEL B WIDTH	PANEL HEIGHT	PANEL TYPE	PANEL MATERIAL	PANEL FINISH	FRAME TYPE	FRAME MATERIAL				FRAME FINISH
100.1	2	VERIFY	VERIFY	8' - 3"	GP	AL	PT	AL	AL	PT	-	SEE NOTES	
100.2	2	VERIFY	VERIFY	8' - 3"	GP	AL	PT	AL	AL	PT	-	SEE NOTES	

PROJECT NAME:
GERMANIA APARTMENTS
ENTRY REPLACEMENT
135 WEST WELLS
MILWAUKEE, WI 53203

OWNERS INFO:
CARDINAL CAPITAL
MANAGEMENT, INC.
901 S. 70TH STREET
WEST ALLIS, WI 53214
P 414.727.9902

ARCHITECT:
KORB + ASSOCIATES
ARCHITECTS
648 N. PLANKINTON AVE.
SUITE 240
MILWAUKEE, WI 53203
P 414.273.8230

REV. NO.	DATE:
1	01/01/2020

PROJ. NO: 21005-07
SCALE: AS NOTED
PHASE: CONSTRUCTION SET
DATE: FEBRUARY 4, 2022

FIRST FLOOR PLAN

A100