



CITY OF MILWAUKEE  
OFFICE OF THE CITY CLERK

Wednesday, April 12, 2023

COMMITTEE MEETING NOTICE

AD 03

ORTIZ, George A, Agent  
TUTUCAN, LLC  
2124 N FARWELL Av  
Milwaukee, WI 53202

You are requested to attend a hearing which is to be held in Room 301-B, Third Floor, City Hall or you may attend virtually using the link below.

**Tuesday, April 25, 2023 at 10:20 AM**

The access code is <https://meet.goto.com/623644525>. If you wish to call in: +1 (408) 650-3123 and use Access Code: 623-644-525. Please see the enclosed best practices document for further instructions.

**Regarding:** Your Class B Tavern and Public Entertainment Premises License Applications Requesting Instrumental Musicians and Bands as agent for "TUTUCAN, LLC" for "Cafes" at 2124 N FARWELL Av.

There is a possibility that your application may be denied for one or more of the following reasons: The recommendation of the committee regarding the application shall be based on evidence presented at the hearing. Per MCO 85-2.7-4, probative evidence concerning whether or not a new license should be granted may be presented on the following subjects: whether or not the applicant meets the municipal requirements, the appropriateness of the location and premises where the licensed premises is to be located and whether use of the premises for the purposes or activities permitted by the license would tend to facilitate a public or private nuisance or create undesirable neighborhood problems such as disorderly patrons, unreasonably loud noise, litter, and excessive traffic and parking congestion. Probative evidence relating to these matters may be taken from the plan of operation submitted with the license application, if any, but shall not include the content of any music. Evidence regarding the fitness of the location of the premises to be maintained as the principal place of business, including but not limited to whether there is an overconcentration of businesses of the type for which the license is sought; whether the proposal is consistent with any pertinent neighborhood business or development plans, or the location's proximity to areas where children are typically present. The applicant's record in operating similarly licensed premises; and whether or not the applicant has been charged with or convicted of any felony, misdemeanor, municipal offense or other offense, the circumstances of which substantially relate to the activity to be permitted by the license being applied for or any other factor which reasonably relates to the public health, safety or welfare may also be considered. See attached police report or correspondence.

**Notice for applicants with warrants or unpaid fines:** Proof of warrant satisfaction or payment of fines must be submitted at the hearing on the above date and time. Failure to comply with this requirement may result in a delay of the granting/denial of your application.

Failure to appear at this meeting may result in the denial of your license. Individual applicants must appear only in person or by an attorney. Corporate or Limited Liability applicants must appear only by the agent designated on the application or by an attorney. Partnership applicants must appear by a partner listed on the application or by an attorney. If you wish to do so and at your own expense, you may be accompanied by an attorney of your choosing to represent you at this hearing.

You will be given an opportunity to speak on behalf of the application and to respond and challenge any charges or reasons given for the denial. No petitions can be accepted by the committee, unless the people who signed the petition are present at the committee hearing and willing to testify. You may present witnesses under oath and you may also confront and cross-examine opposing witnesses under oath. If you have difficulty with the English language, you should bring an interpreter with you, at your expense, so that you can answer questions and participate in your hearing.

You may examine the application file at this office during regular business hours prior to the hearing date. Inquiries regarding this matter may be directed to the person whose signature appears below.

Limited parking for persons attending meetings in City Hall is available at reduced rates (5 hour limit) at the Milwaukee Center on the southwest corner of East Kilbourn and North Water Street. Parking tickets must be validated in the first floor information booth in City Hall.

PLEASE NOTE: Upon reasonable notice, efforts will be made to accommodate the needs of disabled individuals through sign language interpreters or other auxiliary aids. For additional information or to request this service, contact the Council Services Division ADA Coordinator at (414) 286-2998, Fax - (414) 286-3456, TDD - (414) 286-2025.

JIM OWZARSKI, CITY CLERK

BY:   
\_\_\_\_\_  
Jim Cooney  
License Division Manager

If you have questions regarding this notice, please contact the License Division at (414) 286-2238.

200 E. Wells Street, Room 105, City Hall, Milwaukee, WI 53202. [www.milwaukee.gov/license](http://www.milwaukee.gov/license)  
Phone: (414) 286-2238 Fax: (414) 286-3057 Email Address: License@milwaukee.gov





CITY OF MILWAUKEE  
OFFICE OF THE CITY CLERK

Wednesday, April 12, 2023

COMMITTEE MEETING NOTICE

AD 03

ORTIZ, George A, Agent  
TUTUCAN, LLC  
161 W WISCONSIN AV #299  
Milwaukee, WI 53203

You are requested to attend a hearing which is to be held in Room 301-B, Third Floor, City Hall or you may attend virtually using the link below.

**Tuesday, April 25, 2023 at 10:20 AM**

The access code is <https://meet.goto.com/623644525>. If you wish to call in: +1 (408) 650-3123 and use Access Code: 623-644-525.  
Please see the enclosed best practices document for further instructions.

**Regarding:** Your Class B Tavern and Public Entertainment Premises License Applications Requesting Instrumental Musicians and Bands as agent for "TUTUCAN, LLC" for "Sonora's" at 2124 N FARWELL Av.

There is a possibility that your application may be denied for one or more of the following reasons: The recommendation of the committee regarding the application shall be based on evidence presented at the hearing. Per MCO 85-2.7-4, probative evidence concerning whether or not a new license should be granted may be presented on the following subjects: whether or not the applicant meets the municipal requirements, the appropriateness of the location and premises where the licensed premises is to be located and whether use of the premises for the purposes or activities permitted by the license would tend to facilitate a public or private nuisance or create undesirable neighborhood problems such as disorderly patrons, unreasonably loud noise, litter, and excessive traffic and parking congestion. Probative evidence relating to these matters may be taken from the plan of operation submitted with the license application, if any, but shall not include the content of any music. Evidence regarding the fitness of the location of the premises to be maintained as the principal place of business, including but not limited to whether there is an overconcentration of businesses of the type for which the license is sought; whether the proposal is consistent with any pertinent neighborhood business or development plans, or the location's proximity to areas where children are typically present. The applicant's record in operating similarly licensed premises; and whether or not the applicant has been charged with or convicted of any felony, misdemeanor, municipal offense or other offense, the circumstances of which substantially relate to the activity to be permitted by the license being applied for or any other factor which reasonably relates to the public health, safety or welfare may also be considered. See attached police report or correspondence.

**Notice for applicants with warrants or unpaid fines:**

**Proof of warrant satisfaction or payment of fines must be submitted at the hearing on the above date and time. Failure to comply with this requirement may result in a delay of the granting/denial of your application.**

Failure to appear at this meeting may result in the denial of your license. Individual applicants must appear only in person or by an attorney. Corporate or Limited Liability applicants must appear only by the agent designated on the application or by an attorney. Partnership applicants must appear by a partner listed on the application or by an attorney. If you wish to do so and at your own expense, you may be accompanied by an attorney of your choosing to represent you at this hearing.

You will be given an opportunity to speak on behalf of the application and to respond and challenge any charges or reasons given for the denial. No petitions can be accepted by the committee, unless the people who signed the petition are present at the committee hearing and willing to testify. You may present witnesses under oath and you may also confront and cross-examine opposing witnesses under oath. If you have difficulty with the English language, you should bring an interpreter with you, at your expense, so that you can answer questions and participate in your hearing.

You may examine the application file at this office during regular business hours prior to the hearing date. Inquiries regarding this matter may be directed to the person whose signature appears below.

Limited parking for persons attending meetings in City Hall is available at reduced rates (5 hour limit) at the Milwaukee Center on the southwest corner of East Kilbourn and North Water Street. Parking tickets must be validated in the first floor information booth in City Hall.

PLEASE NOTE: Upon reasonable notice, efforts will be made to accommodate the needs of disabled individuals through sign language interpreters or other auxiliary aids. For additional information or to request this service, contact the Council Services Division ADA Coordinator at (414) 286-2998, Fax - (414) 286-3456, TDD - (414) 286-2025.

JIM OWCZARSKI, CITY CLERK

BY: \_\_\_\_\_

Jim Cooney  
License Division Manager

**If you have questions regarding this notice, please contact the License Division at (414) 286-2238.**

200 E. Wells Street, Room 105, City Hall, Milwaukee, WI 53202. [www.milwaukee.gov/license](http://www.milwaukee.gov/license)  
Phone: (414) 286-2238 Fax: (414) 286-3057 Email Address: [License@milwaukee.gov](mailto:License@milwaukee.gov)

Date: 3/24/2023  
Officer: PLUMLEY

City of Milwaukee Police Department  
90-5-1.5 Crime Prevention Survey  
Tavern Inspection

Name of Premise: Sonora's  
Address: 2124 N Farwell Av  
Phone:

Owner: George Ortiz  
Owner address: 161 W Wisconsin Av #299  
City State Zip: Milwaukee WI 53203  
Owner Phone: 773-580-1474  
Owner email: [georgeo.al.ortiz@gmail.com](mailto:georgeo.al.ortiz@gmail.com)

Licensee/Agent: George Ortiz  
Home Address: 161 W Wisconsin Av #299  
City State Zip: Milwaukee WI 53203  
Phone: 773-580-1474  
Email: [georgeo.al.ortiz@gmail.com](mailto:georgeo.al.ortiz@gmail.com)

Preferred contact: Phone

Location currently open:  YES  NO

Projected open date: 5/1/2023

Day's open: S M T W Th F SA ALL

Hours of Operation: Sun: 11A-9P 24 hours Y N  
Mon: 11A-9P  
Tue: 11A-9P  
Wed: 11A-9P  
Thu: 11A-9P  
Fri: 11A-9P  
Sat: 11A-9P

Premise Type: Tavern/Bar  
Restaurant  
Other:

Licenses currently held:

Alcohol:  Yes  No Class: #:  
 Tobacco:  Yes  No #: #:  
 Food:  Yes  No #: #:  
 Extended Hours:  Yes  No #: #:  
 Secondhand Dealer:  Yes  No Type: #:  
 Other:  Yes  No Type: #:  
 Other:  Yes  No Type: #:

**Exterior Survey:**

1. Is the area around the location clean?  Yes  No
2. What surrounds the location? (Check all the apply)
  - a.  Park
  - b.  School
  - c.  Youth Center
  - d.  Church
  - e.  Tavern(s) If so, how many
  - f.  Residential
  - g.  Other businesses
  - h.  Other:
3. Can you see from the outside of the location into the interior  Yes  No
4. Can you see the employees inside of the location from the outside  Yes  No
5. Are exterior windows free of signage  Yes  No
6. Is there a parking lot  Yes  No
7. Is the parking lot clean?  Yes  No
8. Off-Street parking  Yes  No
9. Is the parking lot well lit?  Yes  No
10. Valet Parking  Yes  No
  - a. Will this lot have a guard?  Yes  No
  - b. Will this lot have cameras?  Yes  No
11. Are there areas where a person could conceal themselves  Yes  No
12. Is there exterior lighting?  Yes  No. Does it appears to be adequate  Yes  No
13. Exterior Payphone?  Yes  No
14. Are there No Loitering Signs posted?  Yes  No
15. Are there exterior security cameras  Yes  No How Many:
16. Are the address numbers prominently displayed and easy to see  Yes  No

**Camera Survey:**

17. Does this location have security cameras?  Yes  No
18. Are they in working order?  Yes  No
19. What format are the cameras?
  - a. Color  Yes  No
  - b. Digital  Yes  No
  - c. Recorded  Yes  No
20. How long is footage stored for later viewing:
21. Are there exterior cameras  Yes  No How many:
22. Are there interior cameras  Yes  No How many:
23. Do all employees know how to retrieve recorded digital images/footage?  Yes  No

24. Cameras located in parking lot Yes No How many

**Interior Survey:**

- 25. What is the planned capacity 62
- 26. What is the minimum number of employees That will be on premise 2
- 27. Is the storeowner willing to be a standing complainant regarding loitering? Yes No
  - a. If yes have them fill out the standing complaint form and give them two of the commercial signs Yes No
- 28. Is the interior of the location neat and clean? Yes No
- 29. Does an interior camera face the entrance/exit? Yes No
- 30. Is there a lockable area that separates employees from customers? Yes No
- 31. Are emergency and non-emergency numbers posted near the phone? Yes No
- 32. Does the owner know how to contact their police district directly? Yes No
  - a. Did you provide a district contact guide to the owner? Yes No

**Security**

- 33. How many security personnel are going to be employed: 0
- 34. How ill they be deployed: Interior Exterior
- 35. What days will they be deployed MonTueWedThuFriSatSun
- 36. Will the security be managed by business or contracted
- 37. Will they be armed Yes No
- 38. What type of security measures to be used:
  - Wanding/metal detector
  - ID Scanner
  - Dress Code
  - Cover Charge
  - Age restriction
  - Other

**ADDITIONAL COMMENTS/RECOMMENDATIONS:**

Agent of this location informed me he plans to add multiple surveillence cameras to the interior and exterior of the establishment. I discussed adding No Loitering signs to the exterior of the establishment. The agent does plant to add some decorative lighting to the exterior of the building.



# City of Milwaukee Concentration Map

## Area of Interest (AOI) Information

Area : 21,862,585.6 ft<sup>2</sup>

Mar 8 2023 12:25:14 Central Standard Time

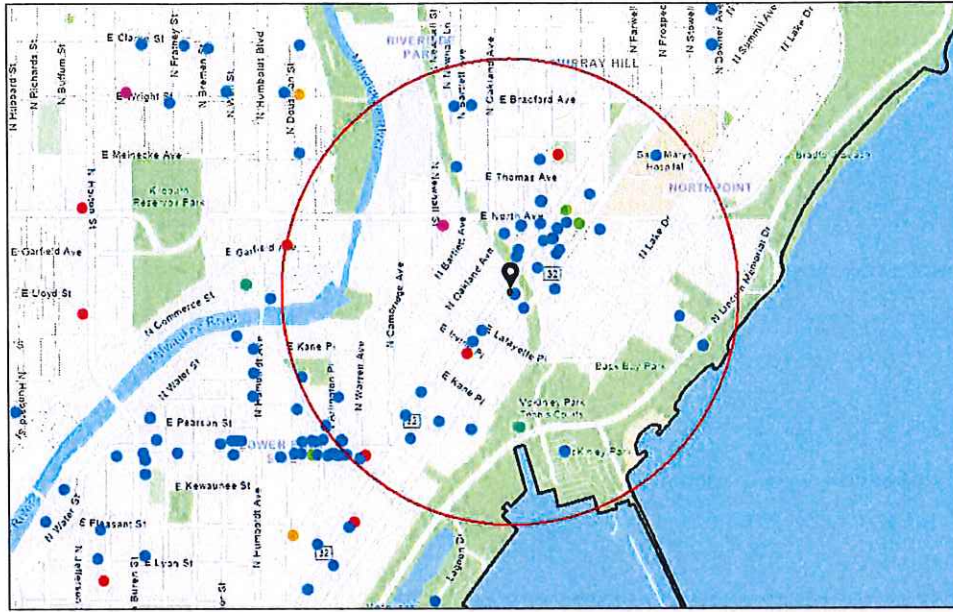

Alcohol Licenses (active)	<span style="color: red;">●</span> Class A Liquor and Mall	<span style="color: green;">●</span> Class C Wine Retailer	 <p>1:18,056</p>
<span style="color: pink;">●</span> Class A Intoxicating Liquor	<span style="color: teal;">●</span> Class B Fermented Malt Beverage	 City Limits	
<span style="color: orange;">●</span> Class A Fermented Malt Beverage	<span style="color: blue;">●</span> Class B Tavern		

File Created: 3/8/2023 12:25:14 PM. City of Milwaukee. All Milwaukee County Land Info. Data: HERE, Garmin, NAVTEQ, GeoTrust, GeoEye, Inc.

### Summary

Name	Count	Area(ft <sup>2</sup> )	Length(mi)
Alcohol Licenses	69		

### Alcohol Licenses



#	Legal Entity	Trade Name	Licensee	Address	License Type Name	Total Capacity	Expiration Date	Count
1	NOMADIC VENTURES, INC	NOMAD WORLD PUB	MICHAEL J EITEL, Agt	1401 E BRADY-1668 N WARREN ST	Class B Tavern License	99	3/8/2023, 6:00 PM	1
2	El Grupo J & K, LLC	Judy's on North / El Grupo J & K	Kevin I Lopez, Agt	2207 E North AV	Class B Tavern License		3/8/2023, 6:00 PM	1
3	MILAP, INC	SMITH BEER & LIQUOR MART	AMARJIT S KALSEY, Agt	1413 E BRADY ST	Class A Malt & Class A Liquor License		3/21/2023, 7:00 PM	1
4	JAMOHEAD, INC	JAMO'S	JAMISON H GOLL, Agt	1800 N ARLINGTON PL	Class B Tavern License	25	3/24/2023, 7:00 PM	1
5	Colectivo Coffee Roasters Inc	Colectivo Coffee Roasters Inc	William D Suskey, Agt	1701 N LINCOLN MEMORIAL DR	Class B Fermented Malt Beverage Retailer's License		3/29/2023, 7:00 PM	1
6	SPTresto, LLC	Rice N Roll Bistro	Bundid Muangsiri, Agt	1952 N Farwell AV	Class C Wine Retailer's License		3/29/2023, 7:00 PM	1
7	SPTresto, LLC	Rice N Roll Bistro	Bundid Muangsiri, Agt	1952 N Farwell AV	Class B Fermented Malt Beverage Retailer's License		3/29/2023, 7:00 PM	1
8	Saz's Catering Inc	Jan Serr Studio	Stephanie L Sazama-Schneck, Agt	2155 N Prospect AV	Class B Tavern License		4/4/2023, 7:00 PM	1
9	PROSPECTOR PARTNERSHIP LLC	VINTAGE	REBECCA E GODFREY, Agt	2203 N PROSPECT AV	Class B Tavern License	151	4/10/2023, 7:00 PM	1
10	LANDMARK BARS, INC	LANDMARK LANES	SLAVA TUZHILKOV, Agt	2220 N FARWELL AV	Class B Tavern License	240	4/11/2023, 7:00 PM	1
11	GPJ OF MILWAUKEE, INC	MA FISCHER'S	HEIDI A PANAGIOTOP OULOS, Agt	2214 N FARWELL AV	Class B Tavern License	240	4/11/2023, 7:00 PM	1
12	ZAFFIRO BROS, INC	ZAFFIRO'S PIZZA	MICHAEL J ZAFFIRO, Agt	1724 N FARWELL AV	Class B Tavern License	25	4/17/2023, 7:00 PM	1
13	MEGA MARTS, LLC	PICK 'N SAVE #882	Matthew M Conrad, Agt	1100 E GARFIELD AV	Class A Malt & Class A Liquor License		4/17/2023, 7:00 PM	1
14	FRANKIES RESTAURANT AND CATERING, LLC	Frankies Restaurant and Catering	Donna D Afrifa, Agt	1815 E KENILWORTH PL	Class B Tavern License		5/10/2023, 7:00 PM	1
15	DP Hospitality Group LLC	Tavolino	Peter J Dietrich, Agt	2315 N MURRAY AV	Class B Tavern License	99	5/26/2023, 7:00 PM	1
16	Axe MKE, Inc	Axe MKE	Marla R Poytinger, Agt	1924 E KENILWORTH PL	Class B Tavern License		5/30/2023, 7:00 PM	1
17	Nine Below Inc	Nine Below	Marla R Poytinger, Agt	1905 E North AV	Class B Tavern License	270	5/30/2023, 7:00 PM	1



18	BENJAMIN'S FINE WINE & SPIRITS LLC	Waterford Wine Company	BENJAMIN T CHRISTIANS EN, Agt	2120 N FARWELL AV	Class B Tavern License		5/30/2023, 7:00 PM	1
19	Good City Brewing LLC	Good City Brewing	David C Dupee, Agt	2108 N Farwell AV	Class B Tavern License		5/31/2023, 7:00 PM	1
20	WHOLE FOODS MARKET GROUP, INC	WHOLE FOODS MARKET	Brooke M Remitz, Agt	2305 N PROSPECT AV	Class B Tavern License		6/13/2023, 7:00 PM	1
21	Black Gate LLC	Von Trier	MARK A ZIERATH, Agt	2235 N Farwell AV	Class B Tavern License	153	6/13/2023, 7:00 PM	1
22	Dairyland Retail Group LLC	7-Eleven #35852B	Elizabeth J Evans, Agt	1609 E NORTH AV	Class A Fermented Malt Beverage Retailer's License		6/14/2023, 7:00 PM	1
23	Dairyland Retail Group LLC	7-Eleven #35852B	Elizabeth J Evans, Agt	1609 E NORTH AV	Class A Retailer's Intoxicating Liquor License		6/14/2023, 7:00 PM	1
24	CHAMPION'S PUB, LLC	CHAMPION'S PUB	ROBERT R GREENYA, Agt	2417 N BARTLETT AV	Class B Tavern License	148	6/28/2023, 7:00 PM	1
25	OCTOPUS, LTD	WOLSKI'S TAVERN	DENNIS BONDAR, Agt	1836 N PULASKI ST	Class B Tavern License	80	6/29/2023, 7:00 PM	1
26	HOOLIGAN'S SUPER IRISH DELI & BAR, INC	HOOLIGAN'S	MARK B BUESING, Agt	2017 E NORTH AV	Class B Tavern License	118	6/29/2023, 7:00 PM	1
27	M P ON BRADY, INC	CLUB BRADY	MICHAEL D LEE, Agt	1339 E BRADY ST	Class B Tavern License	143	6/29/2023, 7:00 PM	1
28	MILWAUKEE YACHT CLUB	MILWAUKEE YACHT CLUB	Matthew F Michael, Agt	1700 N LINCOLN MEMORIAL DR	Class B Tavern License	180	7/5/2023, 7:00 PM	1
29	TKCS Brady LLC	The King Crab Shack	Tien Ngo, Agt	1330 E Brady ST	Class B Tavern License		7/5/2023, 7:00 PM	1
30	BRG Lotta Burger, LLC	Roundhouse	CHRISTIAN M DAMIANO, Agt	1750 N Lincoln Memorial DR	Class B Tavern License	112	7/10/2023, 7:00 PM	1
31	CONCOCTIONS LLC	CONCOCTIONS	HYACINTH E NEMBHARDT, Agt	1316 E BRADY ST	Class B Tavern License		7/23/2023, 7:00 PM	1
32	Dock Bradford, LLC	The Dock at Bradford Beach	BRIAN C RANDALL, Agt	2400 N Lincoln Memorial DR	Class B Tavern License		7/26/2023, 7:00 PM	1
33	MOOSA BURGER, INC.	Moosa's	ALAA I MUSA, Agt	2272 N LINCOLN MEMORIAL DR	Class B Tavern License		7/28/2023, 7:00 PM	1
34	WV, LLC	TESS	MITCHELL D WAKEFIELD, Agt	2499 N BARTLETT AV	Class B Tavern License	60	7/30/2023, 7:00 PM	1
35	IFM Farwell LLC	Oriental Theatre	Kristen C Heller, Agt	2230 N FARWELL AV	Class B Tavern License	1,834	7/31/2023, 7:00 PM	1

36	Sip & Purr LLC	Sip & Purr Cat Cafe	Katherine E McHugh, Agt	2021 E Ivanhoe PL	Class B Tavern License		8/30/2023, 7:00 PM	1
37	BEANS & BARLEY, INC	BEANS & BARLEY	JAMES C NEUMEYER, Agt	1901 E NORTH AV	Class B Tavern License	180	8/30/2023, 7:00 PM	1
38	La Masa LLC	La Masa	BRADLEY H TODD, Agt	1300 E Brady ST	Class B Tavern License	99	8/30/2023, 7:00 PM	1
39	BALZAC, INC	BALZAC WINE BAR	SCOTT M JOHNSON, Agt	1716 N ARLINGTON PL	Class B Tavern License	100	8/30/2023, 7:00 PM	1
40	The Original MKE, LLC	The Original	Eric E Rzepka, Agt	2498 N Bartlett AV	Class B Tavern License	99	9/3/2023, 7:00 PM	1
41	Kawa Ramen & Sushi Inc	Kawa	LinJin Xiao, Agt	2321-23 N Murray AV	Class B Tavern License		9/12/2023, 7:00 PM	1
42	Milwaukee Catholic Home Inc	Milwaukee Catholic Home	Christopher A Reinheimer, Agt	2462 N PROSPECT AV	Class B Tavern License		9/18/2023, 7:00 PM	1
43	Ardent Milwaukee, LLC	Ardent	Justin K Carlisle, Agt	1749-51 N Farwell AV	Class B Tavern License		10/13/2023, 7:00 PM	1
44	Colectivo Coffee Roasters Inc	Colectivo Coffee Roasters Inc	Curtis W Fowler, Agt	2211 N Prospect AV	Class B Tavern License	299	10/17/2023, 7:00 PM	1
45	Yangzi, LLC	Huan Xi	Jun Yang, Agt	2428 N Murray AV	Class B Fermented Malt Beverage Retailer's License		10/31/2023, 7:00 PM	1
46	Yangzi, LLC	Huan Xi	Jun Yang, Agt	2428 N Murray AV	Class C Wine Retailer's License		10/31/2023, 7:00 PM	1
47	The National, LLC	The LaFayette Place	Amy R Plennes, Agt	1978 N Farwell AV	Class B Tavern License		11/3/2023, 7:00 PM	1
48	Door County Brewing Co, LLC	Hacienda Beer Co	James W Anderson, Agt	2018 E North AV	Class C Wine Retailer's License	240	11/24/2023, 6:00 PM	1
49	Crossroads Collective, LLC	Crossroads Collective	TIM B GOKHMAN, Agt	2238 N Farwell AV	Class B Tavern License	231	12/10/2023, 6:00 PM	1
50	The Jazz Estate Inc	The Jazz Estate	JOHN M DYE, Agt	2423 N MURRAY AV	Class B Tavern License	62	12/14/2023, 6:00 PM	1
51	Stone Bowl Grill, LLC	Stone Bowl	Young B Kim, Agt	1958-62 N Farwell AV	Class B Tavern License	99	12/15/2023, 6:00 PM	1
52	Strange Town, LLC	Strange Town	Mia L LeTendre, Agt	2101-2103 N Prospect AV	Class B Tavern License	49	12/18/2023, 6:00 PM	1
53	APOLLO CAFE	APOLLO CAFE	PETER A LIMBERATOS, VIVIAN ANTON-LIMBERATOS	1310 E BRADY ST	Class B Tavern License	100	12/19/2023, 6:00 PM	1

54	Charles Allis and Villa Terrace Museums, Inc.	Charles Allis Art Museum	Jaymee Harvey Willms, Agt	1801 N PROSPECT AV	Class B Tavern License	99	1/11/2024, 6:00 PM	1
55	MAA VERA, INC.	Murray Pantry	Sandipkumar M Patel, Agt	2430 N MURRAY AV	Class A Malt & Class A Liquor License		1/16/2024, 6:00 PM	1
56	Saint John's Communities, Inc	Saint John's on the Lake	Renee E Anderson, Agt	1840 N PROSPECT AV	Class B Tavern License		2/3/2024, 6:00 PM	1
57	Pomona Cider Company LLC	Pomona Cider Company	Thomas S Gabert, Agt	2163 N FARWELL AV	Class B Tavern License		2/5/2024, 6:00 PM	1
58	Izzy Hops LLC	Izzy Hops	MICHAEL J VITUCCI, Agt	2311 N Murray AV	Class B Tavern License		2/6/2024, 6:00 PM	1
59	Woori Wells Corp	Maru	Jongsoo Kim, Agt	2150 N Prospect AV	Class B Tavern License		2/6/2024, 6:00 PM	1
60	Erth Wellness, LLC	Kind Oasis	Salem J Kashou, Agt	2169 N FARWELL AV	Class B Tavern License		2/7/2024, 6:00 PM	1
61	Charles Allis and Villa Terrace Museums, Inc.	Villa Terrace Decorative Arts Museum	Jaymee Harvey Willms, Agt	2220 N TERRACE AV	Class B Tavern License	85	2/21/2024, 6:00 PM	1
62	Krikar LLC	Koppa's Fulbeli Deli	Karthik B Pothumachi, Agt	1940 N FARWELL AV	Class A Malt & Class A Liquor License		2/26/2024, 6:00 PM	1
63	Ian's Pizza Milwaukee, LLC	Ian's Pizza Milwaukee	Ryan W Donovan, Agt	2035 E NORTH AV	Class C Wine Retailer's License		3/1/2024, 6:00 PM	1
64	Ian's Pizza Milwaukee, LLC	Ian's Pizza Milwaukee	Ryan W Donovan, Agt	2035 E NORTH AV	Class B Fermented Malt Beverage Retailer's License		3/1/2024, 6:00 PM	1
65	PADDY'S PET & PUB, LLC	PADDY'S PET & PUB	ORLEN G WOOD, Agt	2339-A N MURRAY AV	Class B Tavern License	179	3/1/2024, 6:00 PM	1
66	PIZZA SHUTTLE, INC	PIZZA SHUTTLE	MARK H GOLD, Agt	1827 N Farwell AV	Class B Tavern License	150	3/6/2024, 6:00 PM	1
67	NOMADIC VENTURES, INC	NOMAD WORLD PUB	MICHAEL J EITEL, Agt	1401 E BRADY-1668 N WARREN ST	Class B Tavern License	99	3/8/2024, 6:00 PM	1
68	ZUM ZEPPEL, LLC	Thurmans 15	Richard J Paul, Agt	1731 N Arlington PL	Class B Tavern License	80	3/9/2024, 6:00 PM	1
69	MILAP, INC	SMITH BEER & LIQUOR MART	AMARJIT S KALSEY, Agt	1413 E BRADY ST	Class A Malt & Class A Liquor License		3/21/2024, 7:00 PM	1

Establishments within a 0.5 miles radius centered on area of interest.



Wednesday, April 12, 2023



# Notice of Public Hearing

Blank Notice

---

ORTIZ, George A, Agent  
Sonora's at 2124 N FARWELL Av  
Class B Tavern and Public Entertainment Premises License Applications Requesting Instrumental  
Musicians and Bands

**Tuesday, April 25, 2023 at 10:20 AM**

To whom it may concern:

The above application has been made by the above named applicant(s). This requires approval from the Licenses Committee and the Common Council of the City of Milwaukee. The hearing before the Licenses Committee will take place on 4/25/2023 at 10:20 AM in Room 301-B, Third Floor, City Hall. This is a public hearing. Those wishing to view the proceeding are able to do so via the City Channel – Channel 25 on Spectrum Cable – or on the Internet at <http://city.milwaukee.gov/citychannel>. Those wishing to provide oral testimony via phone or internet are asked to contact the staff assistant, Yadira Melendez at (414) 286-2775 or [stasst5@milwaukee.gov](mailto:stasst5@milwaukee.gov) for necessary information. Please make such requests no later than one business day prior to the start of the meeting. You are not required to attend the hearing, but please see the information below if you would like to provide testimony. Once the Licenses Committee makes its recommendation, this recommendation is forwarded to the full Common Council for approval at its next regularly scheduled hearing.

---

## Important details for those wishing to provide information for the Licenses Committee to consider when making its recommendation:

1. The license application is scheduled to be heard at the above time. Due to other hearings running longer than scheduled, you may have to wait some time to provide your testimony.
2. You must appear in person and testify as to matters that you have personally experienced or seen. (You cannot provide testimony for your neighbor, parent or anyone else; this is considered hearsay and cannot be considered by the committee.)
3. No letters or petitions can be accepted by the committee (unless the person who wrote the letter or the persons who signed the petition are present at the committee hearing and willing to testify).
4. Persons opposed to the license application are given the opportunity to testify first; supporters may testify after the opponents have finished.
5. When you are called to testify, you will be sworn in and asked to give your name, and address. (If your first and/or last names are uncommon please spell them.)
6. You may then provide testimony.
  - a. Include only information relating to the above license application.
  - b. Include only information you have personally witnessed or seen.
  - c. Provide concise and relevant information detailing how this business has affected or may affect the peaceful enjoyment of your neighborhood.
  - d. If by the time you have the opportunity to testify, the information you wish to share has already been provided to the committee, you may state that you agree with the previous testimony. Redundant or repetitive testimony will not assist the committee in making its recommendation.
7. After giving your testimony, the members of the Licenses Committee and the licensee may ask questions regarding the testimony you have given or other factors relating to the license application.
8. Business Competition is not a valid basis for denial or non-renewal of a license.  
**Please Note: If you have submitted an objection to the above application your objection cannot be considered by the committee unless you personally testify at the hearing.**



























CURRENT OCCUPANT 2134 N OAKLAND AVE MILWAUKEE, WI 53202-1132

Blank Notice

Total Records: 470

Radius 250.0 feet and Center of the Circle: 2124 N Farwell Av



# BUSINESS LICENSE PLAN OF OPERATION

ccl-busplan 5/12/2020

Office of the City Clerk License Division  
200 E. Wells St. Room 105, Milwaukee, WI 53202  
(414) 286-2238 www.milwaukee.gov/license e-mail address: license@milwaukee.gov

## 1. Type of Business

Applying for:  Extended Hours (12AM to 5AM) - If a food establishment, check all that apply:  Delivery  Drive Thru  Dining Room  
 Self Service Laundry  Massage Establishment  Filling Station  
 Other (supplemental application for specific license also required)

Provide a detailed description of the type of business you plan on operating:

FULL SERVICE RESTAURANT

Do you have any experience operating this type of business?  No  Yes If yes, explain: Professional chef

## 2. Business Operations

- a. Proposed Opening Date: ASAP
- b. Is this premise under construction?  No  Yes If yes, list estimated completion date: \_\_\_\_\_
- c. Is this a franchise?  No  Yes
- d. Is this premises currently licensed?  No  Yes If yes, list type of license: \_\_\_\_\_
- e. Is the current licensee operating?  No  Yes If no, list date closed: \_\_\_\_\_
- f. Do you have future plans for other businesses, licenses or permits at this location?  No  Yes  
If yes, explain: \_\_\_\_\_
- g. Have you previously held an Extended Hours License in Milwaukee?  No  Yes  
If yes, list address(es): \_\_\_\_\_
- h. Are other businesses operating in the same building?  No  Yes If yes, describe: OTHER LEASED AND OPERATING BUSINESSES

## 3. Litter & Noise

- a. How are grounds kept clean?  Sweep  Pressure Wash  Pick Up Litter  Other: \_\_\_\_\_
- b. How often will grounds be cleaned?  Daily  Weekly  As Needed  Monthly  Other: \_\_\_\_\_
- c. Grounds cleaned by:  Licensee  Building Owner  Employees  Hired Maintenance  Other: \_\_\_\_\_
- d. How are noise issues prevented and/or addressed?  Security  Manager approaches customer(s)  Call Police  
 Signs Posted  Other: \_\_\_\_\_
- e. Will a sound amplification system be used?  No  Yes If yes, describe: \_\_\_\_\_

## 4. Smoking & Sanitation

- a. Are there designated outdoor smoking areas?  No  Yes If yes, describe: \_\_\_\_\_
- b. Number of Garbage Cans: Inside: 10 Locations: (1) ENTRANCE, (2) BAR, (2) RESTROOMS, (5) KITCHEN  
Outside: 1 Locations: REAR OF BUILDING
- c. Is a crowd control barrier used?  No  Yes If yes, describe: \_\_\_\_\_
- d. How many restrooms are on the premises? 2
- e. Name of solid waste contractor:  Advanced Disposal  Waste Management  Other: Eagle Disposal, Inc.



## 5. Security

- a. Are there onsite parking spaces?  No  Yes If yes, how many? 10 and describe the parking security plan: SIDE AND REAR OF BUILDING SHARED PARKING SLOTS ; Cameras
- b. Is there a loading zone?  No  Yes If yes, describe the loading area security plan: \_\_\_\_\_
- c. Will you have security personnel on premise?  No  Yes If yes, how many? \_\_\_\_\_ and answer the following:  
 What are their responsibilities? \_\_\_\_\_  
 Is security equipment used?  No  Yes If yes, describe \_\_\_\_\_  
 List their licensing, certification, or training credentials \_\_\_\_\_
- d. Will there be security cameras?  No  Yes If yes, how many? 6 and list locations: parking lot, kitchen, front door, cashier station, bar area and dining area
- e. Will searches/identification checks be done upon entry?  No  Yes If yes, describe \_\_\_\_\_

## 6. Percentage of Sales (must total 100%)

Alcohol <u>20</u> %	Food <u>80</u> %	Secondhand Merchandise _____ %	Precious Metals & Gems _____ %
Entertainment _____ %	Cigarettes _____ %	Personal Services (such as tattoo, body piercing, salon, tailor, tanning, etc.) _____ %	Other _____ % Describe: _____
Pawnbroker Activity _____ %	Salvaged Materials _____ % (such as scrap metal)		

## 7. Businesses/Licenses on the Premises (check all that apply):

### Type 1

- Full Service Restaurant  Cafe/Coffee Shop  Deli or Fast Food Restaurant  Private/Fraternal/Veterans Club
- Night Club  Tavern  Cocktail Lounge  Teen Club
- Banquet Hall  Sports Facility  Bowling Alley
- Hotel/Motel : Number of Floors: \_\_\_\_\_ Number of Rooms: \_\_\_\_\_  
 Rooming House: Number of Floors: \_\_\_\_\_ Number of Rooms: \_\_\_\_\_

### Type 2

- Liquor Store  Corner Store  Supermarket  Convenience Store
- Gas Station  Amusement/Phonograph Distributor  Recycling, Salvage or Towing
- Used Car Dealer  Personal Service Establishment (such as tattoo business, hair salon, tailor, etc.)  Recording Studio

What other licenses/permits will you hold at this location? (check all that apply)

- Occupancy Permit  Cigarette & Tobacco  Gas Station  Extended Hours  Class "B" Tavern  Weights & Measures
- Secondhand Dealer  Precious Metal & Gem  Other: \_\_\_\_\_

## 8. Legal Capacity (only if a Type 1 premises in #7 above)

Capacity 63 (Call the Milwaukee Development Center at 414-286-8211 if you have questions.)

## 9. Premises Description

- a. Identify all area(s) of the premises that will be used in operating this business (include areas used only for storage):  
 1<sup>st</sup> Floor  2<sup>nd</sup> Floor  Basement Storage  Patio  Beer Garden  Sidewalk Café  Deck  Rooftop  
 Other: Describe: \_\_\_\_\_
- b. Describe Location:  Major Thoroughfare  Secondary Street  Other: \_\_\_\_\_
- c. Nearest Major Cross Street: FARWELL AVE
- d. Describe Building:  Free Standing Building  Strip Mall  Other: \_\_\_\_\_
- e. Describe Premises Structure:  Single Story  Multi-Story - # of Stories \_\_\_\_\_  Other: \_\_\_\_\_
- f. Describe Surrounding Area:  Commercial  Residential  Industrial  Other: \_\_\_\_\_
- g. Building Owner Name: 2100 NORTH FARWELL AVENUE LLC Phone Number: 414-271-0210  
 Building Owner Address: 219 N. MILWAUKEE ST, MILWAUKEE, WI 53202

## 10. Hours of Operation & Customers

Will customers be entering the premises?  No  Yes

Day of the Week	Proposed Hours of Operation:		Estimated Number of Customers expected each day	Potential Age Range of Customers	Class B Tavern Applicant Only: Age Restriction (If none, write 'None')
	Open Time (include a.m. or p.m.)	Close Time (include a.m. or p.m.)			
Sunday	11:00AM	12:00AM	25-50	21-70	21+
Monday	11:00AM	12:00AM	25-50	21-70	21+
Tuesday	11:00AM	12:00AM	25-50	21-70	21+
Wednesday	11:00AM	12:00AM	25-50	21-70	21+
Thursday	11:00AM	12:00AM	25-50	21-70	21+
Friday	11:00AM	12:00AM	25-50	21-70	21+
Saturday	11:00AM	12:00AM	25-50	21-70	21+

An Extended Hours Establishment License is required for any convenience store, filling station, personal service establishment (such as tattoo, body piercing, salon, tailor, tanning, etc.), recording studio or restaurant which is open between the hours of 12:00 a.m. and 5:00 a.m.

Alcohol Establishments Class A: 8:00 am to 9:00 pm Sunday thru Saturday  
 Permitted Hours of Operation: Class B: 6:00 am to 2:00 am Sunday thru Thursday, 6:00 am to 2:30 am Friday & Saturday

Entertainment Outdoor Closing Hours: 10:00pm Sunday-Thursday; 12:00am Friday & Saturday; unless a different time, either earlier or later, is established by the Common Council in its approval of the licensee's plan of operation.

## 11. Signature(s)

  
 Signature of Sole Proprietor, Partner, or 20% or more Shareholder  
 (If there are no 20% or more shareholders,  
 Corporate Officer-print name/title and sign)

\_\_\_\_\_  
 Signature of additional partner or 20% or more shareholder

See Application Information for a complete list of all required application forms.



## ALCOHOL BEVERAGE & PUBLIC ENTERTAINMENT PREMISES SUPPLEMENTAL APPLICATION

Office of the City Clerk License Division  
200 E. Wells St. Room 105, Milwaukee, WI 53202  
(414) 286-2238 e-mail address: license@milwaukee.gov [www.milwaukee.gov/license](http://www.milwaukee.gov/license)

Legal Entity Name: TUTUCAN, LLC	
Premise Address: 2124 N. Farwell Ave., Milwaukee, WI 53202	
<b>Proximity of Premises to Church, School, Daycare Center or Hospital</b>	
Is the building within 300 feet of any church, school, daycare center or hospital? <input checked="" type="checkbox"/> No <input type="checkbox"/> Yes	
<b>"Service Bar Only" Designation</b>	
If applying for Class B or C license, are you applying for "Service Bar Only"? <input checked="" type="checkbox"/> No <input type="checkbox"/> Yes	
Service Bar Only means customers cannot sit at the bar. Alcohol is served to employees who serve patrons seated at tables. No stools, chairs or other articles of furniture shall be placed at the service bar for patrons to sit upon.	
<b>Business Information</b>	
a) Are you taking out this application for anyone that may not be eligible for a license? <input checked="" type="checkbox"/> No <input type="checkbox"/> Yes If yes, list their name and address: _____	
b) Will the agent, a partner or the individual licensee be conducting the day-to-day operations of the business? <input type="checkbox"/> No <input checked="" type="checkbox"/> Yes If no, list the name and address of the person(s) who will: _____ _____	
Class B Applicants: If the agent, a partner or the individual licensee will not be conducting the day-to-day operations of the business, the person(s) listed above must obtain a Class B Managers license.	
c) Does anyone else have money invested or any other interest in this business? <input checked="" type="checkbox"/> No <input type="checkbox"/> Yes If yes, explain: _____	
d) Have you made an agreement with anyone to repay any loan or any other payments based upon income from the business? <input checked="" type="checkbox"/> No <input type="checkbox"/> Yes If yes, list name and address: _____	
<b>Property Information (New &amp; Transfer Applicants Only)</b>	
a) Do you own or lease the building? <input type="checkbox"/> Own <input checked="" type="checkbox"/> Lease	
b) Who owns the fixtures (for example, coolers, etc.)? <u>Landlord</u>	
c) Are you purchasing the stock and/or fixtures? <input checked="" type="checkbox"/> No <input type="checkbox"/> Yes If yes, amount paid \$ _____	
d) Total amount paid for business <u>\$ N/A</u>	
e) Total amount paid for goodwill of the business <u>\$ N/A</u>	
Goodwill comprises the reputation and customer relationships of an existing business. If the price you pay for the business exceeds the fair market value of all of the rest of the assets of the business, the excess may be considered goodwill.	
f) Have you made arrangements with the seller for payment of personal property taxes? <input type="checkbox"/> No <input checked="" type="checkbox"/> Yes	
<b>Lease Information (New &amp; Transfer Applicants who are leasing the premises only)</b>	
a) Date lease begins <u>02/01/2023</u> Ends <u>02/01/2028</u>	
b) Monthly rental <u>\$ 3,835.00</u>	
c) Do you have an option to renew the lease? <input type="checkbox"/> No <input checked="" type="checkbox"/> Yes	
d) Does your lease allow for assignment to another party without the consent of the owner? <input checked="" type="checkbox"/> No <input type="checkbox"/> Yes	
e) For what length of time have you been guaranteed occupancy (number of years)? <u>5 YEARS</u>	

**Lease Information (Continued)**

- f) In addition to paying the monthly rental, will you have to pay anything additional to the owner of the building to guarantee performance of the lease?  No  Yes If yes, explain \_\_\_\_\_
- g) Does the present owner or occupant object to the granting of your license?  No  Yes  
If yes, explain \_\_\_\_\_

**Change of Agent Applicants Only**

Have there been any changes to the floor plan since the last application was submitted?  No  Yes  
If no, a new floor plan is not required. If yes, submit a new floor plan and explain the change(s):  
\_\_\_\_\_

**Signature**



\_\_\_\_\_  
Signature of Sole Proprietor, Partner or 20% or More Shareholder  
(If no 20% or more Shareholder, Corporate Officer - print name/title and sign)

Note: All information contained in this application is subject to approval by the Common Council.  
Deviating from approved plan of operation will subject licensee to citations, and/or suspension or non-renewal of the license.  
Contact the License Division for information on how to request changes.

**New and transfer of premises applicants must submit the following:**

- Detailed floor plan
- If a restaurant, copy of the menu



## PUBLIC ENTERTAINMENT PREMISES LICENSE SUPPLEMENTAL APPLICATION

Office of the City Clerk License Division  
200 E. Wells St. Room 105, Milwaukee, WI 53202  
(414) 286-2238 [www.milwaukee.gov/license](http://www.milwaukee.gov/license) e-mail address: [license@milwaukee.gov](mailto:license@milwaukee.gov)

**PREMISES ADDRESS:** 2124 N. Farwell Ave., Milwaukee, WI 53202

**TYPES OF ENTERTAINMENT (CHECK ALL THAT APPLY)**

<input checked="" type="checkbox"/> Instrumental Musicians	<input type="checkbox"/> Battle of the Bands	<input type="checkbox"/> Dancing by Performers	<input type="checkbox"/> Amusement Machines How many? _____
<input checked="" type="checkbox"/> Bands	<input type="checkbox"/> Comedy Acts	<input type="checkbox"/> Adult Entertainment/ Strippers/Erotic Dance	<input type="checkbox"/> Concerts Approx. # per year? _____
<input type="checkbox"/> Bowling Alley How many? _____	<input type="checkbox"/> Disc Jockey	<input type="checkbox"/> Wrestling	<input type="checkbox"/> Theatrical Performances Approx. # per year? _____
<input type="checkbox"/> Pool Tables How many? _____	<input type="checkbox"/> Magic Shows	<input type="checkbox"/> Patron Contests	<input type="checkbox"/> Jukebox
<input type="checkbox"/> Motion Pictures (movies by admission) - How many? _____	<input type="checkbox"/> Poetry Readings	Patrons Dancing	<input type="checkbox"/> Karaoke
<input type="checkbox"/> Other: _____			

*Entertainment Outdoor Closing Hours: 10:00pm Sunday-Thursday; 12:00am Friday & Saturday; unless a different time, either earlier or later, is established by the Common Council in its approval of the licensee's plan of operation.*

**PROMOTERS/SOUND AMPLIFICATION**

Will promoters ever be used for any of the entertainment?  No  Yes If Yes, Describe:

At any time will sound amplification be used?  No  Yes If Yes, Describe:

**LEGAL CAPACITY OF PREMISES**

63 (Call the Development Center at 414-286-8211 with questions.) Legal capacity determines the fee for your Public Entertainment Premises License. If you would like to request the license be approved with a lower capacity than that listed above, indicate the lower capacity here: \_\_\_\_\_. If approved, this lower capacity will print on your license and override the capacity listed on your Occupancy Permit.

**ACKNOWLEDGEMENT/SIGNATURE**

I understand that after the license has been issued, a change to the plan of operation will require a written request to change and approval from the Common Council. I agree to inform the City Clerk within 10 days of any substantial changes in the information supplied in this application. I understand that I shall not willfully refuse to provide the services offered under this license, or add charges or require deposits not required of the general public because of race, color, sex, religion, national origin or ancestry, age, handicap, lawful source of income, marital status, sexual orientation, gender identity or expression, familial status or the fact that a person is now or has been a member of the military service, whether dressed in uniform or not; and shall not seek such information as a condition of employment, or penalize any employee or discriminate in the selection of personnel for training or promotion on the basis of such information.

I have knowledge of the City Ordinances currently regulating public entertainment, and understand that the license may be subject to suspension, non-renewal or revocation, if I violate any rule, law or regulation of the city of Milwaukee and State of Wisconsin.

Signature of Sole Proprietor, Partner or 20% or More Shareholder  
(If no 20% or more Shareholder, Corporate Officer - print name/title and sign)

**Office Use Only:**

Initials: \_\_\_\_\_ Filed: \_\_\_\_\_ App: \_\_\_\_\_

Only PEP?  No  Yes If Yes,  Queue to MPD and  Email Mgrs/Team Lead (must be heard w/in 60 days)



# FOOD DEALER LICENSE PLAN OF OPERATION

ccl-foodplan 2/28/19

OFFICE OF THE CITY CLERK, LICENSE DIVISION  
CITY HALL, 200 E. WELLS ST, ROOM 105, MILWAUKEE, WI 53202  
(414) 286-2238 • [license@milwaukee.gov](mailto:license@milwaukee.gov) • [www.milwaukee.gov/license](http://www.milwaukee.gov/license)

Legal Entity Name: **TUTUCAN, LLC**

Premises Address: **2124 N. Farwell Ave., Milwaukee, WI 53202**

## SECTION 1 TYPE OF BUSINESS

What will be the majority of your food sales? (check one)

Restaurant Items (meals):

MEALS include, but are not limited to, chicken, ribs, sandwiches, roasted corn, baked potatoes, hot dogs, brats, tacos, nachos w/ cheese and meat, French fries, cooked or deep fried vegetables/fruit, cooked cheese curds, corn dogs, egg rolls, salads.

Retail Items (snacks and beverages):

RETAIL items include, but are not limited to, ice cream/soft serve, lemonade, snow cones, coffee, espresso, cappuccino, tea, fruit juice, smoothies, candy, dispensed soda, fruit cups, bakery, cookies, kettle corn, cotton candy, funnel cakes, fritters, tortilla chips w/ cheese.

Will it be a convenience store?  Yes  No

A convenience store contains less than 5,000 square feet of retail space and has, as its primary business, the sale of basic food items and in addition, sells household products or is a filling station that sells basic food items and household products.

Bed & Breakfast

Micro Market

All Applicants: Submit a menu or a list of food items that will be sold.

Will any wholesale business be done?  No  Yes If yes, what percentage of food sales will be wholesale?

Less than 25%

25% or More AND:

Restaurant items (meals) will be sold – Complete this application and also contact DATCP.

NO restaurant items (meals) will be sold - Do NOT complete this application. Contact DATCP only.

## SECTION 2 FOOD PROCESSING

Will any food processing be done?  No  Yes

Processing is defined as assembling, grinding, cutting, mixing, baking, coating, stuffing, packing, bottling, grilling, canning, extracting, fermenting, distilling, pickling, freezing, drying, smoking, or packaging.

## SECTION 3 FOOD REQUIRING TEMPERATURE CONTROL

Will any food that requires temperature control be sold?  No  Yes  
(includes dairy products such as milk, cheese, and ice cream, fish, shellfish, meat, poultry)

If yes, list the types of food items: MEAT, CHEESE, POULTRY



**SECTION 4 DETAILS OF OPERATION**

Will you have seating on site for dining?  No  Yes

Will you be doing any catering?  No  Yes

Will you be doing any delivery?  No  Yes

Will you have outdoor activities?  No  Yes - Check all that apply:  Bar  Cooking/Grilling  Dining

Will you have a drive thru window?  No  Yes - Are hours different from inside?  No  Yes  
 If Yes, provide drive thru hours: \_\_\_\_\_

Will scales or barcode scanners be used?  No  Yes - You must also apply for a Weights & Measures License.

**SECTION 5 ADDITIONAL SITES**

Where will food be prepared and/or sold?

At a single site  At multiple sites: How many? \_\_\_\_\_ (for example, a hotel with several dining rooms or bars)

If multiple sites, attach a Food Dealer Additional Site Addendum (ccl-foodadd) for each additional site.

**SECTION 6 CONSTRUCTION OR CHANGES**

Are you planning any construction, remodeling or equipment changes?

No If No, SKIP to Section 8

Yes If Yes, check all that apply:  New construction of a building  Renovation or remodeling  
 Construction changes to existing building  Equipment changes only

Provide a brief description of the changes: \_\_\_\_\_

Start date: \_\_\_\_\_

Name, Address & Phone Number of Architect: \_\_\_\_\_  
 \_\_\_\_\_

Name, Address & Phone Number of Contractor: \_\_\_\_\_  
 \_\_\_\_\_

**SECTION 7 ALCOHOL BEVERAGES**

Are you applying for an alcohol beverage license?

No If No, SKIP to Section 9

Yes If YES, if your food license is approved prior to the alcohol license, when do you want the food license issued?  
 Immediately  At the same time as the alcohol license

**SECTION 8 ACKNOWLEDGEMENTS & SIGNATURE**

You must initial each item confirming your understanding:

     I understand the Health Department must conduct an inspection and advise the License Division of their approval before the license may be issued.

     I understand I must obtain an occupancy permit from the Department of Neighborhood Services and an inspection may be required. Neighborhood Services must advise the License Division of their approval before the license may be issued.

     I understand the district alderperson will review and either support or object to my application. If he/she objects, I may appeal and be scheduled to appear before the Licenses Committee. The Licenses Committee will then make a recommendation to the Common Council. The Common Council must grant the license before it may be issued.

     I understand proof of payment for all license fees must be on file in the License Division before the license may be issued and the license must be issued and posted in my establishment prior to opening for business.

     I will not operate my food business until the license has been issued and posted in the establishment.

Signature of Sole Proprietor, Partner, or 20% Shareholder: \_\_\_\_\_

Signature of Additional Partner: \_\_\_\_\_

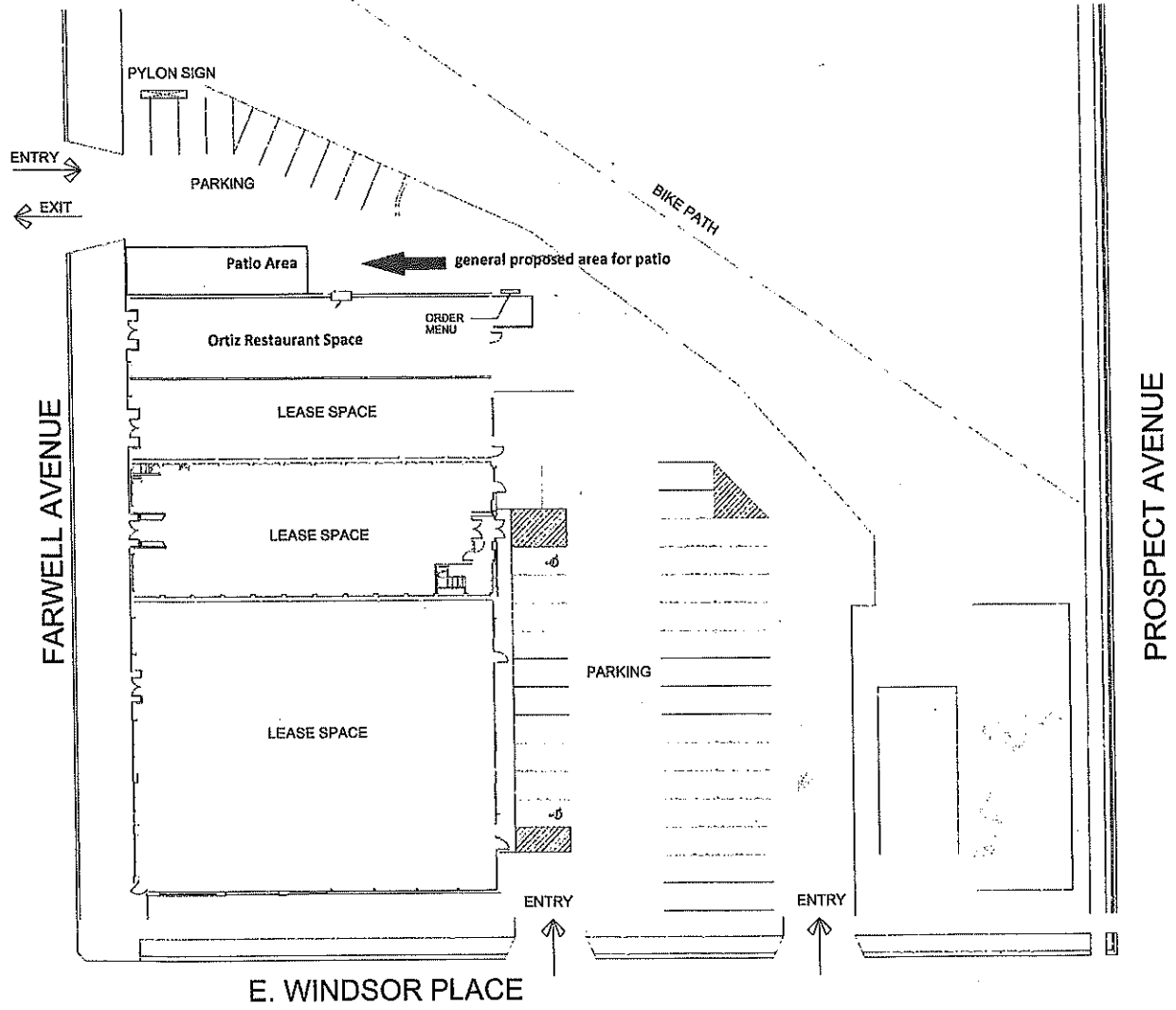

**SITE PLAN**

SCALE : 1" = 20' - 0"



NORTH

Parking

Approximate Square Footage

20,500 sq ft

170'



Parking

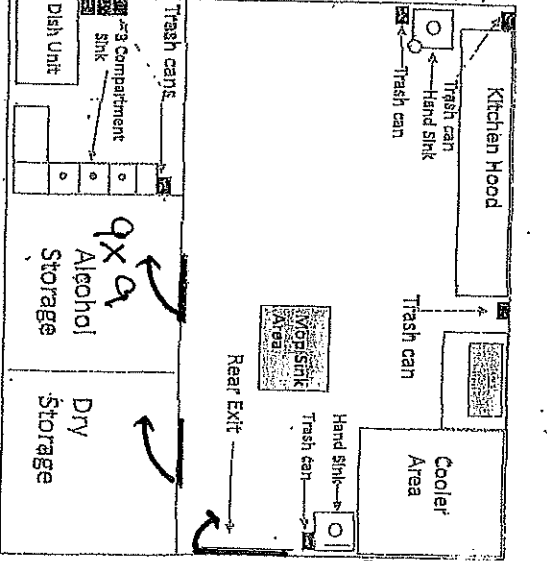
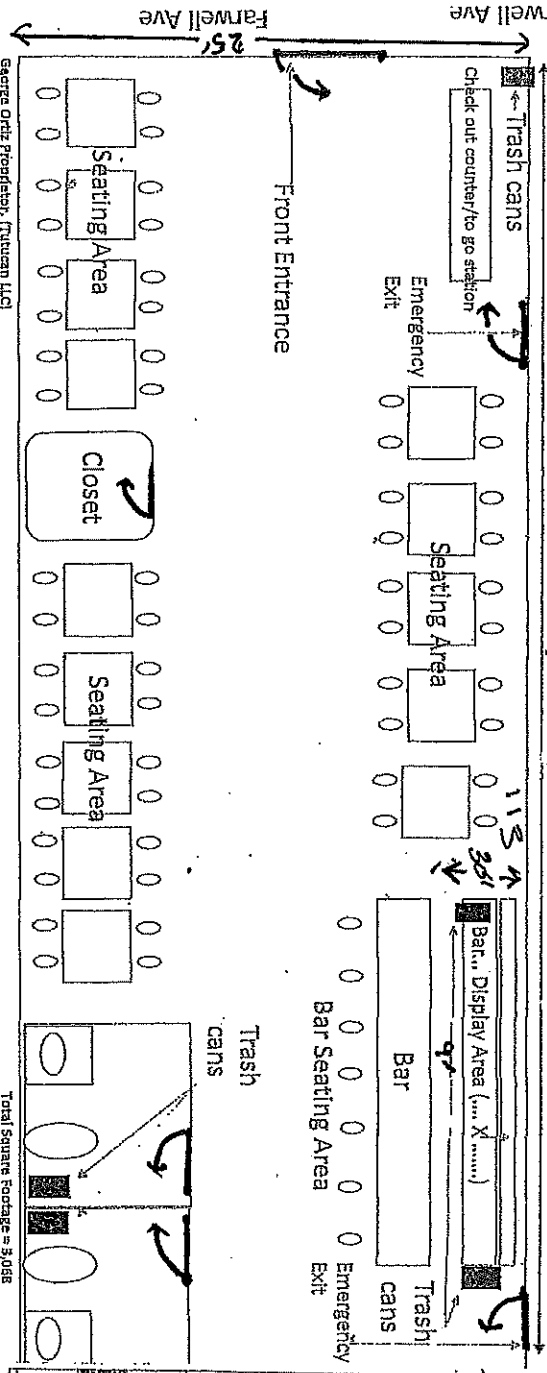
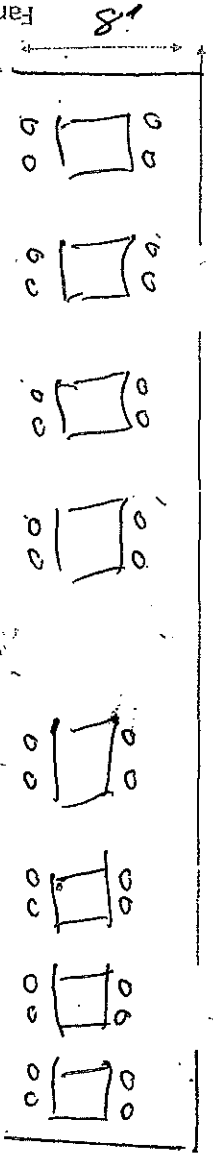

George Ortiz Properties, (Tucson LLC)  
 Sonoran, 2124 N. Farwell Ave., Milaville WI.  
 Date: March 5, 2023

Total Square Footage = 3,088  
 Inside sq. footage 3,068  
 Ratio sq. footage 552  
 Total sq. footage 3,620

NORTH



Parking  
 →

350

# Patio Floor Plan

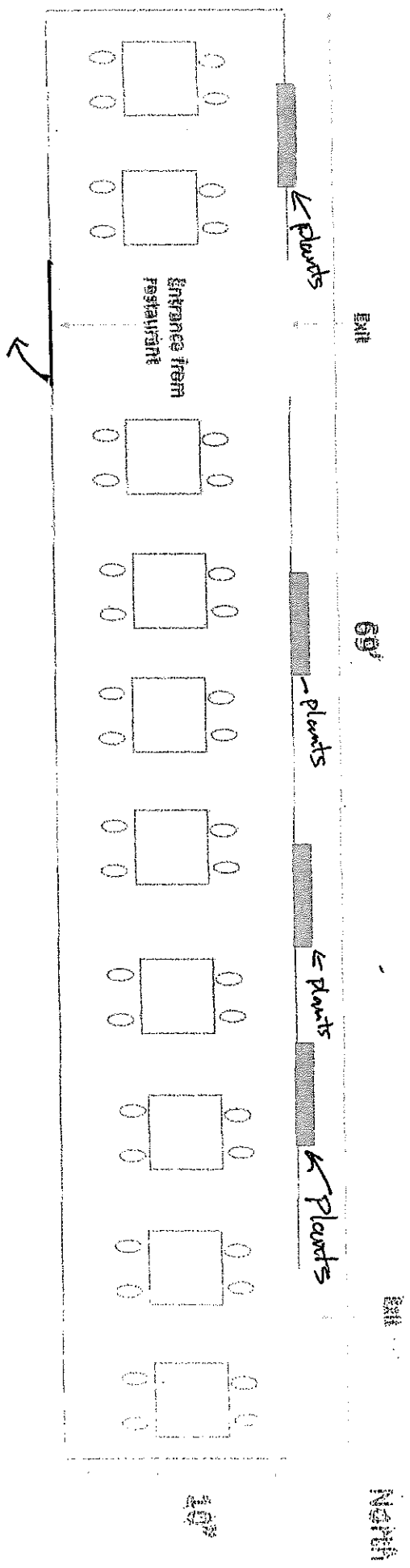

All table measure  
the following:  
40"x40"

March 8, 2022  
Sensors, Tutuon LLC  
2124 N. Farwell Ave., Milwaukee, WI.

Agent: George Ortiz 773-590-1474

Total Square Feet: 598

Total seating: 40

# Sonoras

## Menu

### FOOD - TACOS

1. Carnitas- On Soft Corn Tortilla, Onion, Cilantro And Guacamole Pulled pork	\$4.00
2. Carne Asada- Soft Corn Tortilla, Onion, Cilantro, And Guacamole	\$4.00
2. Mexican steak	\$4.00
Spicy pulled chicken	\$4.00
4. Barbacoa- Soft Corn Tortilla, Onion, Cilantro, And Guacamole Pulled beef	\$4.00
5. Al Pastor- Soft Corn Tortilla, Onion, Cilantro And Guacamole Ground pork and pineapple	\$4.00
6. Chorizo- Soft Corn Tortilla, Onion, Cilantro And Guacamole Spicy ground pork	\$4.00
7. Vegan- Soft Corn Tortilla, Onion, Cilantro, And Guacamole Cauliflower, corn, peppers and onions	\$4.00
8. Fried BEEF Birria -Fried Corn Tortilla, Jack Cheese, Cilantro And Dipping Sauce	\$4.00
9. Shrimp- Flour Tortilla, Slaw, Pico De Gallo, Lettce Lightly breaded fried shrimp	\$4.00
<b>FOOD - TACO FLIGHTS mix and match</b>	
10. Tacos Flight Choose any 5 of our delicious tacos	\$20.00
11. Tacos Flight Chose any 3 tacos (no side included)	\$12.00
12. Quesadilla Large quesadilla with jack cheese and choice of salsa	\$3.00
<b>FOOD - SIDES</b>	
13. Chips And Salsa rojo, verde or pico de gallo	\$3.00
14. Chips And Guacamole traditional guacamole	\$3.00
15. Chips And Queso Chips and queso dip	\$3.00
16. Mexican Rice Seasoned with peas and carrot	\$3.00
17. Refried Beans Refried beans topped with jack cheese	\$3.00

**DRINKS - 20oz COKE PRODUCTS**

Coke 20oz	\$4.00
Diet Coke 20oz	\$4.00
Coke Zero 20oz	\$4.00
Sprite 20oz	\$4.00

**DRINKS - MEXICAN SODA**

Mexican Coke	\$4.00
Mexican Fanta	\$4.00
Mexican Sprite	\$4.00
Jarritos	\$4.00

**ENERGY DRINKS - Red Bull**

Regular	\$5.00
Sugar Free	\$5.00

**LIQUOR (Beer)**

Modelo	\$5.00
Corona	\$5.00
Dos XX	\$5.00
Dos XX Ambar	\$5.00
Tecate	\$5.00
Pacifico	\$5.00

**LIQUOR**

Margaritas	\$8.00
Rocks Margarita	\$8.00
Brandy Old Fashioned	\$8.00
Limodada (lime or lemon)	\$8.00
Sangria	\$8.00

**SIDES**

Rojo Salsa	\$0.75
Verde Salsa	\$0.75
Pico De Gallo Salsa	\$0.75
Sour Cream	\$0.50
Guacamole	\$2.50
Queso Dip	\$1.75
Birria Dip	\$2.50
Chipotle Dip	\$0.75