

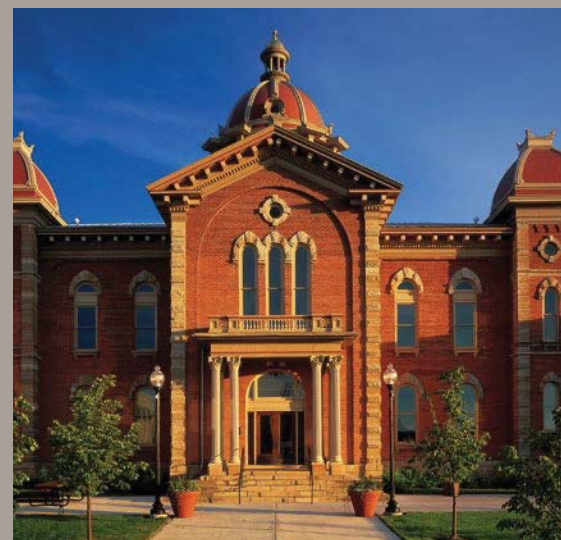

Heritage Series Product Catalog

KOLBE
WINDOWS & DOORS



We're for the visionaries.™



We're for people who take building to new levels.

We're for people who are passionate about design, who care about the big picture and the smallest detail. We're for people who aren't satisfied with mainstream options. They push the limits of what's possible with the options, innovations and custom solutions that can only be found in Kolbe windows and doors.



We're for expertise.

We're for people who dream of a personalized design experience. That's why you can't find Kolbe windows and doors in the aisles of a home center. You can only purchase our products from a Kolbe dealer, because Kolbe dealers are as passionate about windows and doors as you are about bringing your vision to life.

Leave the details in the hands of a Kolbe window specialist. They'll work with you to make your dream a concrete reality.

We're for quality craftsmanship.

We're for a tradition of excellence that outlasts the latest design fad. The Kolbe story began with a family and a vision. Almost 70 years after the Kolbe brothers began their commitment to producing premium quality windows and doors, products bearing their family name can be found in some of North America's most impressive homes.

We're for possibilities.

We're for people who don't want to compromise their vision to fit anyone else's idea of "standard." We're for handmade touches and virtually limitless options that can't be found within the aisles of a home center.

At Kolbe, each product is truly built to order. Our team members are craftsmen who focus on building one window or door at a time, so they can create custom-built products to fulfill your vision.



We're for innovation.

We're for people who want to take building to new levels of performance, with advancements in not only extraordinary sizes and shapes, but also ground breaking products. We're for creative thinking that redefines what's possible.

Only Kolbe builds windows and doors that do the things you dream about. We're constantly reimagining our windows and doors to take building to new levels.

Let us bring your vision to life.



Table of Contents

The Kolbe Difference	4-5	Complementary Windows.....	114-127
Casements	6-49	Patio Doors	128-151
Awnings	50-63	Entrance Doors	152-181
Double Hungs	64-97	Options	182-193
Folding Windows, Tilt-Turns, Sliders..	98-113	Technical Data	194-205



Photo courtesy of Kenneth M Wyner Photography, Inc.



Photo courtesy of Kenneth M Wyner Photography, Inc.

The Kolbe Difference

We're well-known for our custom capabilities and have worked with many architects to build unique windows and doors. So, whether you're envisioning windows or doors in a special wood species, looking to bring a historical building back to a state of beauty, or planning an unusual shape or grille pattern, we will work with you to find the perfect solution for your needs.



Residential Construction

Years of innovation at Kolbe have led to products with great design flexibility for high-end residential construction. Whether it's renovation or new construction, we offer products ready to add your signature style into your home. Your design reflects not only an architectural style, but also your individualism – from colonial to contemporary, Kolbe has the products to help you express yourself.



Commercial Capabilities

Each of our windows and doors are built-to-order and uniquely crafted to each project's specifications, providing options and configurations that can be geared toward design solutions for commercial projects. Our technical specialists can help provide support on various aspects of your commercial project.



Historical Renovation

Our reputation of producing high-end windows and doors with attention to intricate details lends itself perfectly to historical renovation projects. Our products are designed to marry traditional design aesthetics with new advances in technology, and we offer numerous options to restore beauty to your project. In addition to providing striking design aesthetics, Kolbe can work with you to meet building codes and historical district requirements.



Energy Efficiency

Kolbe windows and doors are available with a wide variety of glass options to meet your energy needs in any climate. In fact, many Kolbe products meet or exceed ENERGY STAR® guidelines in most climate zones while reducing energy costs for home and business owners.





Sustainable Design

Most components used in Kolbe products are sourced from within 500 miles of our factory, proving we are committed to maintaining ecological sustainability. The species available for our wood products are renewable resources sourced from managed forests, while our standard glass contains 25-30% recycled content. In addition, we have achieved FSC Chain-of-Custody certification and can provide FSC®-certified wood for many of our window and door products (FSC license code FSC-C019541).



Impact Certification

K-Force® impact modifications are available on a number of Kolbe windows and doors. K-Force products are specially designed with the strength and durability to withstand hurricane force winds and flying debris, and are independently tested to meet or exceed strict building codes in coastal regions. There are no unsightly rods or extra locks to fasten, so Kolbe's impact-certified products offer the same beautiful appearance as non-impact products.



Design Options

For almost 70 years, Kolbe products have been all about customization. We offer many options for our windows and doors, including different wood species, custom divided light patterns, tailor-made shapes, and many interior and exterior finishes to perfectly complement the design aesthetic of any project. We're known worldwide for our custom capabilities and have worked with many architects to build distinctive windows and doors – we can help bring your most innovative ideas to life.



Universal Design

Universal design is the concept of creating spaces that are accessible and comfortable for individuals of diverse physical ability levels. Kolbe offers options for a variety of windows and doors that are not only designed to make independent living possible, but to do it with quality, style and flexibility. Kolbe's options such as sill ramps, motorized operators, larger cranks and lever door handles can help make independent living easier.







Photo courtesy of Los Gatos Hotel

Casements

Offering convenience and plenty of daylight, Heritage Series casements provide excellent energy efficiency. Easy to operate handles, corrosion resistant hardware and a secure, concealed multi-point locking system on most products contribute to the integrity of these windows. A multitude of styles are available, including French, push-out, inswing, segment head and half-circle top casements.

*Crank-Out Casements | French Casements | Push-out Casements
Inswing Casements | Picture & Transom Units
Picture Combination | Units Bow & Bay Units | Segment Head & Half-Circle Top Units*



Photo courtesy of Los Gatos Hotel



Photo courtesy of Kenneth M Wyner Photography, Inc.



Crank-Out Casements



Kolbe's crank-out casements combine a simple cranking operation with many options for customization to create a uniquely crafted window with an unobstructed view of the outdoors. By opening and closing easily and effectively, they provide excellent ventilation. Crank handles fold down when not in use to prevent interference with blinds.

Crank-Out Casement Standard Features

- ▶ 1-3/4" thick sash
- ▶ Overall jamb width is 4-9/16"
- ▶ Constructed of pine, with pine interior stops and wood mull casings on mull units
- ▶ Energy efficient, insulating LoE²-270 glass
- ▶ Glazed to the interior with beveled wood glazing beads
- ▶ 1-15/16" exterior brickmould applied
- ▶ All exterior wood parts are preservative-treated
- ▶ Exterior frame and sash are latex primed
- ▶ Fully weatherstripped for a tight seal
- ▶ Interior screens with clay-colored aluminum frames and BetterVue® fiberglass mesh
- ▶ Clay-colored folding handles, operator covers and multi-point locks
- ▶ Dual-arm operators with concealed, adjustable hinges (single-arm operators with concealed, adjustable hinges on "S" Series casements; single-arm operators with Euro hinges for added support on segment head and half-circle top units)

NOTE: All measurements are nominal.

1-15/16" brickmould applied as standard



Hardware

Clay-colored, folding handles are applied to crank-out casement units as standard. Other finishes available are White, Beige, Brass, Antique Brass, Satin Nickel, Antique Nickel, Rustic Umber, and Matte Black. Multi-point lock handles will match operator handle colors.



Folding handle in Clay (closed)

Folding handle in Clay (open)

Multi-Point Lock

Heritage Series crank-out casements feature a multi-point locking system as standard. Up to three locking points are operated to quickly and securely lock units from one convenient location. A sleek, slim-line handle and escutcheon makes windows more attractive. Handles and escutcheons are Clay as standard. Other finishes available are White, Beige, Brass, Antique Brass, Satin Nickel, Antique Nickel, Rustic Umber, and Matte Black finishes.



NOTE: Not available on French casements.



Crank-Out Casement Optional Features

Glass (pgs. 184-185):

- ▶ LoE-180
- ▶ LoE² -240
- ▶ LoE³ -366
- ▶ ThermaPlus™ LoE
- ▶ Patterned, bronze- or gray-lite
- ▶ Tempered or laminated
- ▶ Other options standard to the industry

Divided Lites (pgs. 186-187):

- ▶ Performance divided lites with 5/8", 7/8", 1-1/8", 1-3/4", 2-1/4" or 4-1/2" bars
- ▶ True divided lites with 5/8" LoE² insulating glass and 1-1/8" bars
- ▶ Grilles-in-the-air-space
- ▶ Interior removable wood grilles with 7/8" or 1-1/8" bars and full surrounds

Exterior Finishes (pg. 189):

- ▶ K-Kron II exterior paint finish

Other Options: (custom options are also available)

- ▶ French casements
- ▶ Other wood species and FSC-certified wood (pg. 188)
- ▶ Interior prefinishing (pg. 188)
- ▶ Interior casing (pg. 190)
- ▶ Prep for stool
- ▶ 3-1/2" flat or profiled brickmould, backband on 3-1/2" brickmould and other custom millwork (pg. 190)
- ▶ Projected sill nosing, extended sill horns or no nosing

NOTE: All measurements are nominal.

- ▶ Ovolo and square profile glazing beads and interior divided lite bars (pg. 192)
- ▶ Hardware, multi-point locks and operator covers in White, Beige, Brass, Antique Brass, Satin Nickel, Antique Nickel, Rustic Umber, and Matte Black finishes. Oil-Rubbed* finish is available upon request.
- ▶ Universal design casement handle and lock in White or Clay
- ▶ Fall protection devices and window opening control devices
- ▶ Motorized window system
- ▶ Single-arm operators with Euro hinges
- ▶ Screens with White, Beige, Brass, Dark Bronze Anodized, Clear Anodized and Coal Black frames (Brass frames are not available on radius top units)
- ▶ Screens with aluminum or UltraVue® fiberglass mesh (not available with brass frames)
- ▶ Wood wrapped screens (not available on radius top or "S" series units)
- ▶ Retractable screen kit (pg. 191)
- ▶ Retractable screen covers available as beveled (standard) or square
- ▶ Extension jambs (up to 12" applied; over 12" shipped loose for field application)
- ▶ Galvanized steel installation clips
- ▶ Bow and bay options: insulated platforms, support brackets and oak-veneered head and seat boards
- ▶ High performance or K-Force® impact performance modifications



Push-out Casements

Kolbe's push-out casements have a uniquely simple operation. Simply unlock a handle to push open or pull closed. A tight seal, plus weatherstripping to prevent air infiltration, makes these windows an excellent, energy efficient choice.

Push-Out Casement Standard Features

- ▶ 1-3/4" thick sash
- ▶ Overall jamb width is 4-9/16" (*basic box width is 3-1/2" on wood units, plus extensions*)
- ▶ Constructed of pine, with pine interior stops and wood mull casings on mull units
- ▶ Energy efficient, insulating LoE²-270 glass
- ▶ Glazed to the interior with beveled wood glazing beads
- ▶ 1-15/16" exterior brickmould applied
- ▶ All exterior wood parts are preservative-treated
- ▶ Exterior frame and sash are latex primed
- ▶ Fully weatherstripped for a tight seal
- ▶ Single-point lever handle in an Oil-Rubbed* finish
- ▶ Concealed hinges (*segment head and half-circle top units use Tri-Euro hinges for added support*)

NOTE: All measurements are nominal.

Hardware

Push-out casement handles are single-point in an Oil-Rubbed* finish as standard. Other finishes available are Natural Brass or Satin Nickel. Multi-point handles are also available in Oil-Rubbed,* Natural Brass or Satin Nickel finishes.

*The Oil-Rubbed finish is a living finish, which means that it will change appearance over time with use.





Push-Out Casement Optional Features

Glass (pgs. 184-185):

- ▶ LoE-180
- ▶ LoE² -240
- ▶ LoE³ -366
- ▶ ThermaPlus™ LoE
- ▶ Patterned, bronze- or gray-lite
- ▶ Tempered or laminated
- ▶ Other options standard to the industry

Divided Lites (pgs. 186-187):

- ▶ Performance divided lites with 5/8", 7/8", 1-1/8", 1-3/4", 2-1/4", or 4-1/2" bars
- ▶ True divided lites with 5/8" LoE² insulating glass and 1-1/8" bars
- ▶ Grilles-in-the-airspace
- ▶ Interior removable wood grilles with 7/8" or 1-1/8" bars and full surrounds

Exterior Finishes (pg. 189):

- ▶ K-Kron II exterior paint finish

Other Options: (custom options are also available)

- ▶ French push-out casements
- ▶ Other wood species and FSC-certified wood (pg. 188)

NOTE: All measurements are nominal.

*The Oil-Rubbed finish is a living finish, which means that it will change appearance over time with use.

- ▶ Interior prefinishing (pg. 188)
- ▶ Interior casing (pg. 190)
- ▶ Prep for stool
- ▶ 3-1/2" flat or profiled brickmould, backband on 3-1/2" brickmould and other custom millwork (pg. 190)
- ▶ Projected sill nosing, extended sill horns or no nosing
- ▶ Ovolo and square profile glazing beads and interior divided lite bars (pg. 192)
- ▶ Multi-point handles in Oil-Rubbed,* Natural Brass, or Satin Nickel finishes
- ▶ Wood frame hinged/swinging screen or retractable screen with BetterVue® fiberglass mesh (segment head and half-circle top casements are only available with a hinged/swinging screen)
- ▶ Retractable screen covers available as beveled (standard) or square
- ▶ Screens with UltraVue® fiberglass mesh (hinged/swinging screen only)
- ▶ Extension jambs (up to 12" applied; over 12" shipped loose for field application)
- ▶ Galvanized steel installation clips
- ▶ High performance or K-Force® impact performance modifications

Inswing Casements



Kolbe's inswing casements are inspired by classic French design with modern updates to meet energy efficiency standards, proving it's possible to honor traditionally beautiful design while making a modern architectural statement. Inswing casements open in for ventilation and are available in single or French units.

Inswing Casement Standard Features

- ▶ Constructed of pine, with pine interior stops and wood mull casings on mullied units
- ▶ 1-3/4" thick sash
- ▶ Bottom rail height is 3-1/2"
- ▶ Overall jamb width is 4-9/16"
- ▶ All exterior wood parts are preservative-treated
- ▶ Exterior frame and sash are latex primed
- ▶ Energy efficient, insulating LoE²-270 glass
- ▶ Glazed to the interior with beveled wood glazing beads
- ▶ Fully weatherstripped for a tight seal
- ▶ 1-15/16" exterior brickmould applied to wood units
- ▶ A drip-lip applied to the bottom exterior of the sash and a weep channel system on the sill guard against water infiltration
- ▶ Exterior screens with BetterVue[®] fiberglass mesh and aluminum screen frames in a variety of colors
- ▶ Solid, polished brass handle set as standard
- ▶ Sash hang on 3-1/2" x 3-1/2" butt hinges in a Bright Brass finish
- ▶ Multi-point locking hardware secures the unit

NOTE: All measurements are nominal.

Hardware

Inswing casement windows have a Bright Brass handle set as standard. Other handle finish options include White, Antique Brass, Bronze-colored, Satin Nickel, Antique Nickel, Oil-Rubbed,* or Matte Black. Custom finish options are also available.

*The Oil-Rubbed finish is a living finish, which means that it will change appearance over time with use.



Bright Brass (standard)

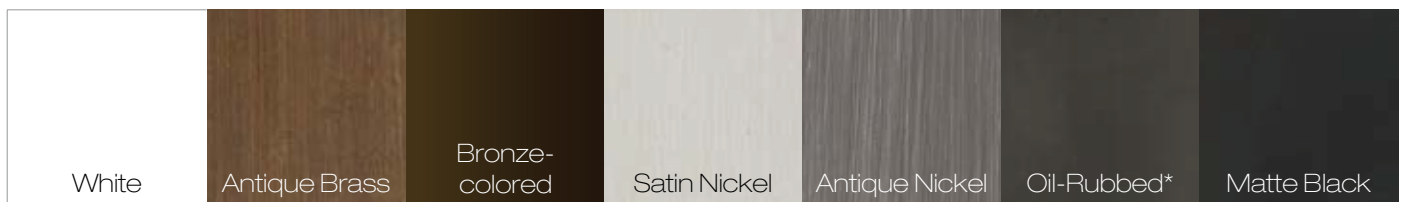



Inswing Casement Optional Features

Glass (pgs. 184-185):

- ▶ LoE-180
- ▶ LoE² -240
- ▶ LoE³ -366
- ▶ ThermaPlus™ LoE
- ▶ Patterned, bronze- or gray-lite
- ▶ Tempered or laminated
- ▶ Other options standard to the industry

Divided Lites (pgs. 186-187):

- ▶ Performance divided lites with 5/8", 7/8", 1-1/8", 1-3/4", 2-1/4", or 4-1/2" bars
- ▶ True divided lites with 5/8" LoE² insulating glass and 1-1/8" bars
- ▶ Grilles-in-the-air-space
- ▶ Interior removable wood grilles with 7/8" or 1-1/8" bars and full surrounds

Exterior Finishes (pg. 189):

- ▶ K-Kron II exterior paint finish

NOTE: All measurements are nominal.

Other Options: (custom options are also available)

- ▶ French inswing casements
- ▶ Other wood species and FSC-certified wood (pg. 188)
- ▶ Interior prefinishing (pg. 188)
- ▶ Interior casing (pg. 190)
- ▶ Prep for stool
- ▶ 3-1/2" flat or profiled brickmould, backband on 3-1/2" brickmould and other custom millwork (pg. 190)
- ▶ Projected sill nosing, extended sill horns or no nosing
- ▶ Ovolo and square profile glazing beads and interior divided lite bars (pg. 192)
- ▶ Handles in Antique Brass, White, Satin Nickel, Antique Nickel, Oil-Rubbed*, Matte Black, or Bronze-colored finishes
- ▶ Screens will match exterior color
- ▶ Screens with aluminum or UltraVue® fiberglass mesh
- ▶ Extension jambs (up to 7")
- ▶ Galvanized steel installation clips

Casements | Elevation Charts

Casements | Single Units

U.D.	1'-6 1/2"	1'-10 1/2"	2'-2 1/2"	2'-6 1/2"	2'-8 1/2"	2'-10 1/2"	3'-2 1/2"
R.O.	1'-4 1/2"	1'-8 1/2"	2'-0 1/2"	2'-4 1/2"	2'-6 1/2"	2'-8 1/2"	3'-0 1/2"
G.S.	11 1/4"	15 1/4"	19 1/4"	23 1/4"	25 1/4"	27 1/4"	31 1/4"
G.S.**	9 13/16"	13 13/16"	17 13/16"	21 13/16"	23 13/16"	25 13/16"	29 13/16"
2'-2"							
2'-8"							
3'-2"							
3'-8"							
4'-2"							
4'-8"							
5'-2"							
5'-8"							
6'-2"							

Dimension Calculations

Elevation charts provide wood unit dimensions for units with the standard 1 15/16" brickmould. Below are the calculations to determine the frame size of units with brickmould.

	Width	Height
1-15/16" brickmould; U.D. to F.S.	-2 1/2"	-2"
3-1/2" flat or profiled casing; U.D. to F.S.	-5 5/8"	-3 9/16"
3-1/2" casing and backband; U.D. to F.S.	-7 1/8"	-4 5/16"

F.S. to Sash O.S.M.	-1 15/16"	1 15/16"
Sash O.S.M. to G.S.	-2 13/16"	2 13/16"
G.S. to D.L.O.	-1"	-1"
G.S. to Screen O.S.M.	+1 9/16"	+1/2"
U.D. to G.S. (for push-outs)	-8 11/16"	-8 3/16"

Note: Clear opening dimensions can be found on pgs. 196-198.

F.S. = Frame Size • G.S. = Glass Size • O.S.M. = Outside Measurement
D.L.O. = Daylight Opening • U.D. = Unit Dimension

NOTE: All measurements are nominal. Elevation charts are not to scale.

Divided lites are optional.

Some installation procedures will require a larger rough opening than noted (i.e. installations utilizing our installation clips), therefore, you may need to increase the rough opening size accordingly. Rough opening gaps may be increased up to a maximum of 1/2" on all sides and still be within good practice guidelines. For rough opening recommendations, see pg. 196.

* Units meet most national emergency escape and rescue requirements

** Glass size for push-out casements

† Push-out units are only available with single-point hardware

PRODUCT CODES:

To order, add "KW" before the product number (Ex: KWE16). For push-out casements, have dealer specify push-out when placing order for unit. Specify stationary, left or right venting when ordering single units. Venting is viewed from the window exterior.

U.D. = Unit Dimension • R.O. = Rough Opening • G.S. = Glass Size

Casements | "S" Series (1'-4" wide)

U.D.	1'-6 1/2"	2'-10 1/2"	4'-2 1/2"	5'-6 1/2"	6'-10 1/2"
R.O.	1'-4 1/2"	2'-8 1/2"	4'-0 1/2"	5'-4 1/2"	6'-8 1/2"
G.S.	11 1/4"	11 1/4"	11 1/4"	11 1/4"	11 1/4"
G.S.**	9 13/16"	9 13/16"	9 13/16"	9 13/16"	9 13/16"
2'-2"					
2'-8"					
3'-2"					
3'-8"					
4'-2"					
4'-8"					
5'-2"					
5'-8"					
6'-2"					

NOTE: All measurements are nominal. Elevation charts are not to scale.

Divided lites are optional. The divided lite configurations shown for single sash are typical for each sash of mulled units.

Some installation procedures will require a larger rough opening than noted (i.e. installations utilizing our installation clips), therefore, you may need to increase the rough opening size accordingly. Rough opening gaps may be increased up to a maximum of 1/2" on all sides and still be within good practice guidelines. For rough opening recommendations, see pg. 196.

** Glass size for push-out casements

† Push-out units are only available with single-point hardware

PRODUCT CODES:

To order, add "KW" before the product number (Ex: KWS22). For push-out casements, have dealer specify push-out when placing order for unit. Specify stationary, left or right venting when ordering single units. Venting is viewed from the window exterior.

U.D. = Unit Dimension • R.O. = Rough Opening • G.S. = Glass Size (Glass sizes are shown per sash)

Casements | Elevation Charts

Casements | "N" Series (1'-8" wide)

U.D.	1'-10 1/2"	3'-6 1/2"	5'-2 1/2"	6'-10 1/2"	8'-6 1/2"
R.O.	1'-8 1/2"	3'-4 1/2"	5'-0 1/2"	6'-8 1/2"	8'-4 1/2"
G.S.	15 1/4"	15 1/4"	15 1/4"	15 1/4"	15 1/4"
G.S.**	13 13/16"	13 13/16"	13 13/16"	13 13/16"	13 13/16"
2'-2"					
2'-8"					
3'-2"					
3'-8"					
4'-2"					
4'-8"					
5'-2"					
5'-8"					
6'-2"					

NOTE: All measurements are nominal. Elevation charts are not to scale.

Divided lites are optional. The divided lite configurations shown for single sash are typical for each sash of mulled units.

Some installation procedures will require a larger rough opening than noted (i.e. installations utilizing our installation clips), therefore, you may need to increase the rough opening size accordingly. Rough opening gaps may be increased up to a maximum of 1/2" on all sides and still be within good practice guidelines. For rough opening recommendations, see pg. 196.

** Glass size for push-out casements

† Push-out units are only available with single-point hardware

PRODUCT CODES:

To order, add "KW" before the product number (Ex: KWN22). For push-out casements, have dealer specify push-out when placing order for unit. Specify stationary, left or right venting when ordering single units. Venting is viewed from the window exterior.

U.D. = Unit Dimension • R.O. = Rough Opening • G.S. = Glass Size (Glass sizes are shown per sash)

Casements | "W" Series (2'-0" wide)

U.D.	2'-2 1/2"	4'-2 1/2"	6'-2 1/2"	8'-2 1/2"	10'-2 1/2"	12'-2 1/2"
R.O.	2'-0 1/2"	4'-0 1/2"	6'-0 1/2"	8'-0 1/2"	10'-0 1/2"	12'-0 1/2"
G.S.	19 1/4"	19 1/4"	19 1/4"	19 1/4"	19 1/4"	19 1/4"
G.S.**	17 13/16"	17 13/16"	17 13/16"	17 13/16"	17 13/16"	17 13/16"
2'-2"	W12†	W22†	W32†	W42†	W52†	W62†
2'-8"	W126†	W226†	W326†	W426†	W526†	W626†
3'-2"	W13	W23	W33	W43	W53	W63
3'-8"	W136	W236	W336	W436	W536	W636
4'-2"	W14	W24	W34	W44	W54	W64
4'-8"	W146	W246	W346	W446	W546	W646
5'-2"	W15	W25	W35	W45	W55	W65
5'-8"	W156	W256	W356	W456	W556	W656
6'-2"	W16	W26	W36	W46	W56	W66

NOTE: All measurements are nominal. Elevation charts are not to scale.

Divided lites are optional. The divided lite configurations shown for single sash are typical for each sash of mulled units.

Some installation procedures will require a larger rough opening than noted (i.e. installations utilizing our installation clips), therefore, you may need to increase the rough opening size accordingly. Rough opening gaps may be increased up to a maximum of 1/2" on all sides and still be within good practice guidelines. For rough opening recommendations, see pg. 196.

** Glass size for push-out casements

† Push-out units are only available with single-point hardware

PRODUCT CODES:

To order, add "KW" before the product number (Ex: KWW22). For push-out casements, have dealer specify push-out when placing order for unit. Specify stationary, left or right venting when ordering single units. Venting is viewed from the window exterior.

U.D. = Unit Dimension • R.O. = Rough Opening • G.S. = Glass Size (Glass sizes are shown per sash)

Casements | Elevation Charts

Casements | "L" Series (2'-4" wide)

U.D.	2'-6 1/2"	4'-10 1/2"	7'-2 1/2"	9'-6 1/2"	11'-10 1/2"	14'-2 1/2"
R.O.	2'-4 1/2"	4'-8 1/2"	7'-0 1/2"	9'-4 1/2"	11'-8 1/2"	14'-0 1/2"
G.S.	23 1/4"	23 1/4"	23 1/4"	23 1/4"	23 1/4"	23 1/4"
G.S.**	21 13/16"	21 13/16"	21 13/16"	21 13/16"	21 13/16"	21 13/16"
2'-2"						
2'-8"						
3'-2"						
3'-8"						
4'-2"						
4'-8"						
5'-2"						
5'-8"						
6'-2"						

NOTE: All measurements are nominal. Elevation charts are not to scale.

Divided lites are optional. The divided lite configurations shown for single sash are typical for each sash of mulled units.

Some installation procedures will require a larger rough opening than noted (i.e. installations utilizing our installation clips), therefore, you may need to increase the rough opening size accordingly. Rough opening gaps may be increased up to a maximum of 1/2" on all sides and still be within good practice guidelines. For rough opening recommendations, see pg. 196.

* Units meet most national emergency escape and rescue requirements when modified with single-arm operators and Euro hinges.

** Glass size for push-out casements

† Push-out units are only available with single-point hardware

PRODUCT CODES:

To order, add "KW" before the product number (Ex: KWL22). For push-out casements, have dealer specify push-out when placing order for unit. Specify stationary, left or right venting when ordering single units. Venting is viewed from the window exterior.

U.D. = Unit Dimension • R.O. = Rough Opening • G.S. = Glass Size (Glass sizes are shown per sash)

Casements | "X" Series (2'-6" wide)

U.D.	2'-8 1/2"	5'-2 1/2"	7'-8 1/2"	10'-2 1/2"	12'-8 1/2"
R.O.	2'-6 1/2"	5'-0 1/2"	7'-6 1/2"	10'-0 1/2"	12'-6 1/2"
G.S.	25 1/4"	25 1/4"	25 1/4"	25 1/4"	25 1/4"
G.S.**	23 13/16"	23 13/16"	23 13/16"	23 13/16"	23 13/16"
2'-2"	X12†	X22†	X32†	X42†	X52†
2'-8"	X126†	X226†	X326†	X426†	X526†
3'-2"	X13	X23	X33	X43	X53
3'-8"	X136	X236	X336	X436	X536
4'-2"	X14*	X24*	X34*	X44*	X54*
4'-8"	X146*	X246*	X346*	X446*	X546*
5'-2"	X15*	X25*	X35*	X45*	X55*
5'-8"	X156*	X256*	X356*	X456*	X556*
6'-2"	X16*	X26*	X36*	X46*	X56*

NOTE: All measurements are nominal. Elevation charts are not to scale.

Divided lites are optional. The divided lite configurations shown for single sash are typical for each sash of mulled units.

Some installation procedures will require a larger rough opening than noted (i.e. installations utilizing our installation clips), therefore, you may need to increase the rough opening size accordingly. Rough opening gaps may be increased up to a maximum of 1/2" on all sides and still be within good practice guidelines. For rough opening recommendations, see pg. 196.

* Units meet most national emergency escape and rescue requirements.

** Glass size for push-out casements

† Push-out units are only available with single-point hardware

PRODUCT CODES:

To order, add "KW" before the product number (Ex: KWX22). For push-out casements, have dealer specify push-out when placing order for unit. Specify stationary, left or right venting when ordering single units. Venting is viewed from the window exterior.

U.D. = Unit Dimension • R.O. = Rough Opening • G.S. = Glass Size (Glass sizes are shown per sash)

Casements | Elevation Charts

Casements | "C" Series (2'-8" wide)

	2'10 1/2"	5'6 1/2"	8'2 1/2"	10'10 1/2"	13'6 1/2"
U.D.	2'10 1/2"	5'6 1/2"	8'2 1/2"	10'10 1/2"	13'6 1/2"
R.O.	2'8 1/2"	5'4 1/2"	8'0 1/2"	10'8 1/2"	13'4 1/2"
G.S.	27 1/4"	27 1/4"	27 1/4"	27 1/4"	27 1/4"
G.S.**	25 13/16"	25 13/16"	25 13/16"	25 13/16"	25 13/16"
2' 2"					
2' 8"					
3' 2"					
3' 8"					
4' 2"					
4' 8"					
5' 2"					
5' 8"					
6' 2"					

NOTE: All measurements are nominal. Elevation charts are not to scale.

Divided lites are optional. The divided lite configurations shown for single sash are typical for each sash of mullied units.

Some installation procedures will require a larger rough opening than noted (i.e. installations utilizing our installation clips), therefore, you may need to increase the rough opening size accordingly. Rough opening gaps may be increased up to a maximum of 1/2" on all sides and still be within good practice guidelines. For rough opening recommendations, see pg. 196.

* Units meet most national emergency escape and rescue requirements.

** Glass size for push-out casements

PRODUCT CODES:

To order, add "KW" before the product number (Ex: KWX22). For push-out casements, have dealer specify push-out when placing order for unit. Specify stationary, left or right venting when ordering single units. Venting is viewed from the window exterior.

U.D. = Unit Dimension • R.O. = Rough Opening • G.S. = Glass Size (Glass sizes are shown per sash)

Casements | "E" Series (3'-0" wide)

U.D.	3'-2 1/2"	6'-2 1/2"	9'-2 1/2"
R.O.	3'-0 1/2"	6'-0 1/2"	9'-0 1/2"
G.S.	31 1/4"	31 1/4"	31 1/4"
G.S.**	29 13/16"	29 13/16"	29 13/16"
3'-2"			
3'-8"			
4'-2"			
4'-8"			
5'-2"			
5'-8"			
6'-2"			

NOTE: All measurements are nominal. Elevation charts are not to scale.

Divided lites are optional. The divided lite configurations shown for single sash are typical for each sash of mullied units.

Some installation procedures will require a larger rough opening than noted (i.e. installations utilizing our installation clips), therefore, you may need to increase the rough opening size accordingly. Rough opening gaps may be increased up to a maximum of 1/2" on all sides and still be within good practice guidelines. For rough opening recommendations, see pg. 196.

* Units meet most national emergency escape and rescue requirements.

** Glass size for push-out casements

PRODUCT CODES:

To order, add "KW" before the product number (Ex: KWE23). For push-out casements, have dealer specify push-out when placing order for unit. Specify stationary, left or right venting when ordering single units. Venting is viewed from the window exterior.

U.D. = Unit Dimension • R.O. = Rough Opening • G.S. = Glass Size (Glass sizes are shown per sash)

Casements | Elevation Charts

Casements | Rectangular Transoms & Picture Units

U.D.	1'-6 1/2"	1'-10 1/2"	2'-2 1/2"	2'-8 1/2"	2'-10 1/2"	3'-2 1/2"	3'-6 1/2"	4'-2 1/2"	4'-8 1/2"	5'-2 1/2"	6'-2 1/2"
R.O.	1'-4 1/2"	1'-8 1/2"	2'-0 1/2"	2'-6 1/2"	2'-8 1/2"	3'-0 1/2"	3'-4 1/2"	4'-0 1/2"	4'-6 1/2"	5'-0 1/2"	6'-0 1/2"
G.S.	11 1/4"	15 1/4"	19 1/4"	25 1/4"	27 1/4"	31 1/4"	35 1/4"	43 1/4"	49 1/4"	55 1/4"	67 1/4"
G.S.*	9 13/16"	13 13/16"	17 13/16"	23 13/16"	25 13/16"	29 13/16"	33 13/16"	41 13/16"	47 13/16"	53 13/16"	65 13/16"
1'-6"											
1'-8"											
1'-10"											
2'-2"											
2'-8"											
3'-2"											
3'-8"											
4'-2"											
4'-8"											
5'-2"											
5'-8"											
6'-2"											

NOTE: All measurements are nominal. Elevation charts are not to scale.

The units shown are stand-alone units. Adjustments may be required when stacking over other units; adjustments will be made in the factory.

Divided lites are optional.

Some installation procedures will require a larger rough opening than noted (i.e. installations utilizing our installation clips), therefore, you may need to increase the rough opening size accordingly. Rough opening gaps may be increased up to a maximum of 1/2" on all sides and still be within good practice guidelines. For rough opening recommendations, see pg. 196.

** Glass size for units to match operating push-out casements

PRODUCT CODES:

To order, add "KW" before the product number (Ex: KWW36P). If unit is to be mulled with a push-out casement, have dealer specify push-out when placing order for unit.

U.D. = Unit Dimension • R.O. = Rough Opening • G.S. = Glass Size

French Casements

U.D.	3'-6 1/2"	4'-2 1/2"	5'-2 1/2"
R.O.	3'-4 1/2"	4'-0 1/2"	5'-0 1/2"
G.S.	16 1/8"	20 1/8"	26 1/8"
G.S.**	14 11/16"	18 11/16"	24 11/16"
3'-2"			
3'-8"			
4'-2"			
4'-8"			
5'-2"			
5'-8"			
6'-2"			

Inswing Casements

Single Unit

U.D.	2'-2 3/4"
R.O.	2-1"
G.S.	19 13/16"
3'-1 3/4"	
3'-7 3/4"	
4'-1 3/4"	
4'-7 3/4"	
5'-1 3/4"	
5'-7 3/4"	
6'-1 3/4"	

Two-Wide French

U.D.	3'-6 1/4"	4'-2 1/4"	5'-2 1/4"
R.O.	3'-4 1/2"	4'-0 1/2"	5'-0 1/2"
G.S.	15 13/16"	19 13/16"	25 13/16"
3'-1 3/4"			
3'-7 3/4"			
4'-1 3/4"			
4'-7 3/4"			
5'-1 3/4"			
5'-7 3/4"			
6'-1 3/4"			

NOTE: All measurements are nominal. Elevation charts are not to scale.

Divided lites are optional.

Some installation procedures will require a larger rough opening than noted (i.e. installations utilizing our installation clips), therefore, you may need to increase the rough opening size accordingly. Rough opening gaps may be increased up to a maximum of 1/2" on all sides and still be within good practice guidelines. For rough opening recommendations, see pg. 196.

* Units meet most national emergency escape and rescue requirements.

** Glass size for push-out casements

PRODUCT CODES:

To order, add "FW" before the product number (Ex: FWN26).

U.D. = Unit Dimension • R.O. = Rough Opening • G.S. = Glass Size (Glass sizes are shown per sash)

Casements | Elevation Charts

Casements | "N" Series Picture Unit Combinations

U.D.	5'-2 1/2"		5'-2 1/2"		6'-10 1/2"			6'-10 1/2"		6'-10 1/2"		8'-6 1/2"		
R.O.	5'-0 1/2"		5'-0 1/2"		6'-8 1/2"			6'-8 1/2"		6'-8 1/2"		8'-4 1/2"		
G.S.**	15 1/4" 35 1/4"		35 1/4" 15 1/4"		15 1/4" 35 1/4" 15 1/4"			15 1/4" 55 1/4"		55 1/4" 15 1/4"		15 1/4" 55 1/4" 15 1/4"		
G.S.**	13 13/16" 33 13/16"		33 13/16" 13 13/16"		13 13/16" 33 13/16" 13 13/16"			13 13/16" 53 13/16"		53 13/16" 13 13/16"		13 13/16" 53 13/16" 13 13/16"		
3'-2"														
3'-8"														
4'-2"														
4'-8"														
5'-2"														
5'-8"														
6'-2"														

NOTE: All measurements are nominal. Elevation charts are not to scale.

Venting is viewed from the exterior.

Divided lites are optional.

Some installation procedures will require a larger rough opening than noted (i.e. installations utilizing our installation clips), therefore, you may need to increase the rough opening size accordingly. Rough opening gaps may be increased up to a maximum of 1/2" on all sides and still be within good practice guidelines. For rough opening recommendations, see pg. 196.

** Glass size for push-out casements.

PRODUCT CODES:

To order, add "KW" before the product number (Ex: KWN56P). For push-out casements, have dealer specify push-out when placing order for unit.

U.D. = Unit Dimension • R.O. = Rough Opening • G.S. = Glass Size

Casements | "W" Series Picture Unit Combinations

U.D.	6'-2 1/2"	6'-2 1/2"	8'-2 1/2"	8'-2 1/2"	8'-2 1/2"	10'-2 1/2"
R.O.	6'-0 1/2"	6'-0 1/2"	8'-0 1/2"	8'-0 1/2"	8'-0 1/2"	10'-0 1/2"
G.S.	19 1/4" 43 1/4"	43 1/4" 19 1/4"	19 1/4" 43 1/4" 19 1/4"	19 1/4" 67 1/4"	67 1/4" 19 1/4"	19 1/4" 67 1/4" 19 1/4"
G.S.**	17 13/16" 41 13/16"	41 13/16" 17 13/16"	17 13/16" 41 13/16" 17 13/16"	17 13/16" 65 13/16"	65 13/16" 17 13/16"	17 13/16" 65 13/16" 17 13/16"
3'-2"	W33PL	W33PR	W43P	W43PL	W43PR	W53P
3'-6"	W336PL	W336PR	W436P	W436PL	W436PR	W536P
4'-2"	W34PL	W34PR	W44P	W44PL	W44PR	W54P
4'-8"	W346PL	W346PR	W446P	W446PL	W446PR	W546P
5'-2"	W35PL	W35PR	W45P	W45PL	W45PR	W55P
5'-8"	W356PL	W356PR	W456P	W456PL	W456PR	W556P
6'-2"	W36PL	W36PR	W46P	W46PL	W46PR	W56P

NOTE: All measurements are nominal. Elevation charts are not to scale.

Venting is viewed from the exterior.

Divided lites are optional.

Some installation procedures will require a larger rough opening than noted (i.e. installations utilizing our installation clips), therefore, you may need to increase the rough opening size accordingly. Rough opening gaps may be increased up to a maximum of 1/2" on all sides and still be within good practice guidelines. For rough opening recommendations, see pg. 196.

** Glass size for push-out casements.

PRODUCT CODES:

To order, add "KW" before the product number (Ex: KWW56P). For push-out casements, have dealer specify push-out when placing order for unit.

U.D. = Unit Dimension • R.O. = Rough Opening • G.S. = Glass Size

Casements | Elevation Charts

Casements | "N" Series Bow Windows

UNIT PROJECTION:		5"	8 9/16"	12 1/16"	17 1/4"	22 5/16"
U.D.		5'-2 3/8"	6'-9 1/2"	8'-4 1/16"	9'-9 15/16"	11'-3 1/16"
R.O.		4'-11 13/16"	6'-6 3/4"	8'-1 1/8"	9'-6 11/16"	10'-11 1/4"
G.S.		15 1/4"	15 1/4"	15 1/4"	15 1/4"	15 1/4"
3'-2"						
		N33BOW	N43BOW	N53BOW	N63BOW	N73BOW
3'-8"						
		N336BOW	N436BOW	N536BOW	N636BOW	N736BOW
4'-2"						
		N34BOW	N44BOW	N54BOW	N64BOW	N74BOW
4'-8"						
		N346BOW	N446BOW	N546BOW	N646BOW	N746BOW
5'-2"						
		N35BOW	N45BOW	N55BOW	N65BOW	N75BOW
5'-8"						
		N356BOW	N456BOW	N556BOW	N656BOW	N756BOW
6'-2"						
		N36BOW	N46BOW	N56BOW	N66BOW	N76BOW

NOTE: All measurements are nominal. Elevation charts are not to scale.

Divided lites are optional.

If the cable support system and/or insulated platforms and support brackets are not being used, other means of proper support must be used. Add 1-11/16" to the R.O. height if an insulated platform is being used. R.O.'s for bow units without head and seat boards, typically used for walk-out applications, are different.

Some installation procedures will require a larger rough opening than noted (i.e. installations utilizing our installation clips), therefore, you may need to increase the rough opening size accordingly. Rough opening gaps may be increased up to a maximum of 1/2" on all sides and still be within good practice guidelines. For rough opening recommendations, see pg. 196.

PRODUCT CODES:

To order, add "KW" before the product number (Ex: KWN76BOW).

U.D. = Unit Dimension • R.O. = Rough Opening • G.S. = Glass Size (Glass sizes are shown per sash)

Casements | "W" Series Bow Windows

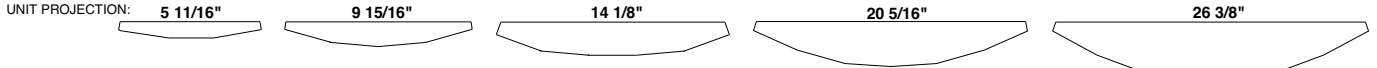

	U.D.	$6'-2 \frac{1}{4}"$	$8'-1 \frac{3}{16}"$	$9'-11 \frac{7}{16}"$	$11'-8 \frac{7}{8}"$	$13'-5 \frac{7}{16}"$
	R.O.	$5'-11 \frac{11}{16}"$	$7'-10 \frac{1}{2}"$	$9'-8 \frac{1}{2}"$	$11'-5 \frac{5}{8}"$	$13'-1 \frac{9}{16}"$
	G.S.	$19 \frac{1}{4}"$	$19 \frac{1}{4}"$	$19 \frac{1}{4}"$	$19 \frac{1}{4}"$	$19 \frac{1}{4}"$
$3'-2"$	$3'-0 \frac{1}{2}"$					
$3'-8"$	$3'-6 \frac{1}{2}"$					
$4'-2"$	$4'-0 \frac{1}{2}"$					
$4'-8"$	$4'-6 \frac{1}{2}"$					
$5'-2"$	$5'-0 \frac{1}{2}"$					
$5'-8"$	$5'-6 \frac{1}{2}"$					
$6'-2"$	$6'-0 \frac{1}{2}"$					

NOTE: All measurements are nominal. Elevation charts are not to scale.

Divided lites are optional.

If the cable support system and/or insulated platforms and support brackets are not being used, other means of proper support must be used. Add $1-11/16"$ to the R.O. height if an insulated platform is being used. R.O.'s for bow units without head and seat boards, typically used for walk-out applications, are different.

Some installation procedures will require a larger rough opening than noted (i.e. installations utilizing our installation clips), therefore, you may need to increase the rough opening size accordingly. Rough opening gaps may be increased up to a maximum of $1/2"$ on all sides and still be within good practice guidelines. For rough opening recommendations, see pg. 196.

PRODUCT CODES:

To order, add "KW" before the product number (Ex: KWW76BOW).

U.D. = Unit Dimension • R.O. = Rough Opening • G.S. = Glass Size (Glass sizes are shown per sash)

Casements | Elevation Charts

Casements | "S" Series 30° Bay Windows

UNIT PROJECTION: 10 7/16"

	4'-2 11/16"	5'-6 11/16"	6'-10 11/16"
U.D.	4'-2 11/16"	5'-6 11/16"	6'-10 11/16"
R.O.	3'-10 7/8"	5'-2 7/8"	6'-6 7/8"
G.S.	11 1/4"	11 1/4"	11 1/4"
3'-2"			
3'-0 1/2"	S13-13-13	S13-23-13	S13-33-13
3'-8"			
3'-6 1/2"	S136-136-136	S136-236-136	S136-336-136
4'-2"			
4'-0 1/2"	S14-14-14	S14-24-14	S14-34-14
4'-8"			
4'-6 1/2"	S146-146-146	S146-246-146	S146-346-146
5'-2"			
5'-0 1/2"	S15-15-15	S15-25-15	S15-35-15
5'-8"			
5'-6 1/2"	S156-156-156	S156-256-156	S156-356-156
6'-2"			
6'-0 1/2"	S16-16-16	S16-26-16	S16-36-16

NOTE: All measurements are nominal. Elevation charts are not to scale.

Divided lites are optional.

If the cable support system and/or insulated platforms & support brackets are not being used, other means of proper support must be used. Add 1-11/16" to the R.O. height if an insulated platform is being used. R.O.'s for bay units without head and seat boards, typically used for walk-out applications, are different.

Some installation procedures will require a larger rough opening than noted (i.e. installations utilizing our installation clips), therefore, you may need to increase the rough opening size accordingly. Rough opening gaps may be increased up to a maximum of 1/2" on all sides and still be within good practice guidelines. For rough opening recommendations, see pg. 196.

PRODUCT CODES:









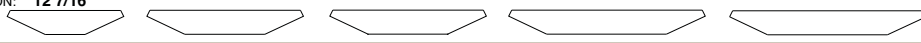

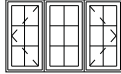
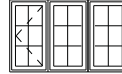
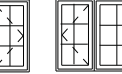
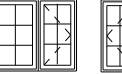



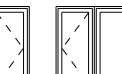
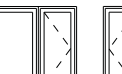



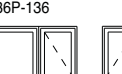

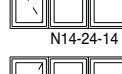

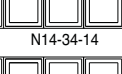



To order, add "30KW" before the product number (Ex: 30KWS13-13-13).

U.D. = Unit Dimension • R.O. = Rough Opening • G.S. = Glass Size (Glass sizes are shown per sash)

Casements | "N" Series 30° Bay Windows

UNIT PROJECTION: 12 7/16"

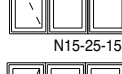

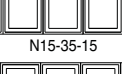
	5'-1 5/8"	6'-9 5/8"	6'-9 5/8"	8'-5 5/8"	8'-5 5/8"
R.O.	4'-9 3/4"	6'-5 3/4"	6'-5 3/4"	8'-1 3/4"	8'-1 3/4"
G.S.	15 1/4"	15 1/4"	15 1/4" 35 1/4" 15 1/4"	15 1/4"	15 1/4" 55 1/4" 15 1/4"
3'-2" 3'-0 1/2" 31 1/4"	 N13-13-13	 N13-23-13	 N13-23P-13	 N13-33-13	 N13-33P-13
3'-8" 3'-6 1/2" 37 1/4"	 N136-136-136	 N136-236-136	 N136-236P-136	 N136-336-136	 N136-336P-136
4'-2" 4'-0 1/2" 43 1/4"	 N14-14-14	 N14-24-14	 N14-24P-14	 N14-34-14	 N14-34P-14
4'-8" 4'-6 1/2" 49 1/4"	 N146-146-146	 N146-246-146	 N146-246P-146	 N146-346-146	 N146-346P-146
5'-2" 5'-0 1/2" 55 1/4"	 N15-15-15	 N15-25-15	 N15-25P-15	 N15-35-15	 N15-35P-15
5'-8" 5'-6 1/2" 61 1/4"	 N156-156-156	 N156-256-156	 N156-256P-156	 N156-356-156	 N156-356P-156
6'-2" 6'-0 1/2" 67 1/4"	 N16-16-16	 N16-26-16	 N16-26P-16	 N16-36-16	 N16-36P-16

NOTE: All measurements are nominal. Elevation charts are not to scale.

Divided lites are optional.

If the cable support system and/or insulated platforms and support brackets are not being used, other means of proper support must be used. Add 1-11/16" to the R.O. height if an insulated platform is being used. R.O.'s for bay units without head and seat boards, typically used for walk-out applications, are different.

Some installation procedures will require a larger rough opening than noted (i.e. installations utilizing our installation clips), therefore, you may need to increase the rough opening size accordingly. Rough opening gaps may be increased up to a maximum of 1/2" on all sides and still be within good practice guidelines. For rough opening recommendations, see pg. 196.

PRODUCT CODES:

To order, add "30KW" before the product number (Ex: 30KWN16-36P-16).

U.D. = Unit Dimension • R.O. = Rough Opening • G.S. = Glass Size (Glass sizes are shown per sash)

Casements | Elevation Charts

Casements | "W" Series 30° Bay Windows

UNIT PROJECTION: 14 7/16"

	6'-0 9/16"	8'-0 9/16"	8'-0 9/16"	10'-0 9/16"	10'-0 9/16"
U.D.	6'-0 9/16"	8'-0 9/16"	8'-0 9/16"	10'-0 9/16"	10'-0 9/16"
R.O.	5'-8 11/16"	7'-8 11/16"	7'-8 11/16"	9'-8 11/16"	9'-8 11/16"
G.S.	19 1/4"	19 1/4"	19 1/4" 43 1/4" 19 1/4"	19 1/4"	19 1/4" 67 1/4" 19 1/4"
3'-2" 3'-0 1/2" 31 1/4"	W13-13-13	W13-23-13	W13-23P-13	W13-33-13	W13-33P-13
3'-8" 3'-6 1/2" 37 1/4"	W136-136-136	W136-236-136	W136-236P-136	W136-336-136	W136-336P-136
4'-2" 4'-0 1/2" 43 1/4"	W14-14-14	W14-24-14	W14-24P-14	W14-34-14	W14-34P-14
4'-8" 4'-6 1/2" 49 1/4"	W146-146-146	W146-246-146	W146-246P-146	W146-346-146	W146-346P-146
5'-2" 5'-0 1/2" 55 1/4"	W15-15-15	W15-25-15	W15-25P-15	W15-35-15	W15-35P-15
5'-8" 5'-6 1/2" 61 1/4"	W156-156-156	W156-256-156	W156-256P-156	W156-356-156	W156-356P-156
6'-2" 6'-0 1/2" 67 1/4"	W16-16-16	W16-26-16	W16-26P-16	W16-36-16	W16-36P-16

NOTE: All measurements are nominal. Elevation charts are not to scale.

Divided lites are optional.

If the cable support system and/or insulated platforms and support brackets are not being used, other means of proper support must be used. Add 1-11/16" to the R.O. height if an insulated platform is being used. R.O.'s for bay units without head and seat boards, typically used for walk-out applications, are different.

Some installation procedures will require a larger rough opening than noted (i.e. installations utilizing our installation clips), therefore, you may need to increase the rough opening size accordingly. Rough opening gaps may be increased up to a maximum of 1/2" on all sides and still be within good practice guidelines. For rough opening recommendations, see pg. 196.

PRODUCT CODES:

To order, add "30KW" before the product number (Ex: 30KWW16-36P-16).

U.D. = Unit Dimension • R.O. = Rough Opening • G.S. = Glass Size (Glass sizes are shown per sash)

Casements | "X" Series 30° Bay Windows

UNIT PROJECTION: 17 7/16"

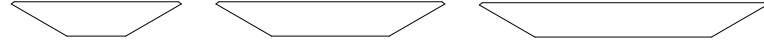

	7'-4 5/8"	9'-10 5/8"	12'-4 5/8"
U.D.	7'-1 1/8"	9'-7 1/8"	12'-1 1/8"
R.O.	25 1/4"	25 1/4"	25 1/4"
G.S.	25 1/4"	25 1/4"	25 1/4"
3'-2"			
3'-0 1/2"	X13-13-13	X13-23-13	X13-33-13
3'-8"			
3'-6 1/2"	X136-136-136	X136-236-136	X136-336-136
4'-2"			
4'-0 1/2"	X14-14-14	X14-24-14	X14-34-14
4'-8"			
4'-6 1/2"	X146-146-146	X146-246-146	X146-346-146
5'-2"			
5'-0 1/2"	X15-15-15	X15-25-15	X15-35-15
5'-8"			
5'-6 1/2"	X156-156-156	X156-256-156	X156-356-156
6'-2"			
6'-0 1/2"	X16-16-16	X16-26-16	X16-36-16

NOTE: All measurements are nominal. Elevation charts are not to scale.

Divided lites are optional.

If the cable support system and/or insulated platforms and support brackets are not being used, other means of proper support must be used. Add 1-11/16" to the R.O. height if an insulated platform is being used. R.O.'s for bay units without head and seat boards, typically used for walk-out applications, are different.

Some installation procedures will require a larger rough opening than noted (i.e. installations utilizing our installation clips), therefore, you may need to increase the rough opening size accordingly. Rough opening gaps may be increased up to a maximum of 1/2" on all sides and still be within good practice guidelines. For rough opening recommendations, see pg. 196.

PRODUCT CODES:

To order, add "30KW" before the product number (Ex: 30KWX13-13-13).











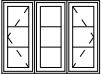
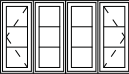
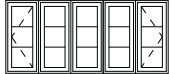
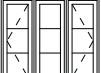
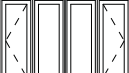

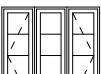

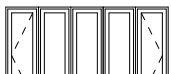
U.D. = Unit Dimension • R.O. = Rough Opening • G.S. = Glass Size (Glass sizes are shown per sash)

Casements | Elevation Charts

Casements | "S" Series 45° Bay Windows

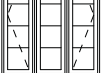
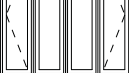
UNIT PROJECTION: 14 5/8"



	U.D.	3'-10 15/16"	5'-2 15/16"	6'-6 15/16"
	R.O.	3'-5 15/16"	4'-9 15/16"	6'-1 15/16"
	G.S.	11 1/4"	11 1/4"	11 1/4"
3'-2"	3'-0 1/2"			
	31 1/4"	S13-13-13	S13-23-13	S13-33-13
3'-8"	3'-6 1/2"			
	37 1/4"	S136-136-136	S136-236-136	S136-336-136
4'-2"	4'-0 1/2"			
	43 1/4"	S14-14-14	S14-24-14	S14-34-14
4'-8"	4'-6 1/2"			
	49 1/4"	S146-146-146	S146-246-146	S146-346-146
5'-2"	5'-0 1/2"			
	55 1/4"	S15-15-15	S15-25-15	S15-35-15
5'-8"	5'-6 1/2"			
	61 1/4"	S156-156-156	S156-256-156	S156-356-156
6'-2"	6'-0 1/2"			
	67 1/4"	S16-16-16	S16-26-16	S16-36-16

NOTE: All measurements are nominal. Elevation charts are not to scale.

Divided lites are optional.

If the cable support system and/or insulated platforms and support brackets are not being used, other means of proper support must be used. Add 1-11/16" to the R.O. height if an insulated platform is being used. R.O.'s for bay units without head and seat boards, typically used for walk-out applications, are different.

Some installation procedures will require a larger rough opening than noted (i.e. installations utilizing our installation clips), therefore, you may need to increase the rough opening size accordingly. Rough opening gaps may be increased up to a maximum of 1/2" on all sides and still be within good practice guidelines. For rough opening recommendations, see pg. 196.

PRODUCT CODES:

To order, add "45KW" before the product number (Ex: 45KWS13-13-13).

U.D. = Unit Dimension • R.O. = Rough Opening • G.S. = Glass Size (Glass sizes are shown per sash)

Casements | "N" Series 45° Bay Windows

UNIT PROJECTION: 17 1/2"

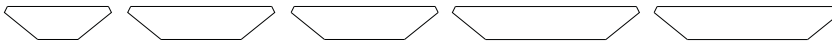

U.D.	4'-8 9/16"	6'-4 9/16"	6'-4 9/16"	8'-0 9/16"	8'-0 9/16"
R.O.	4'-3 5/8"	5'-11 5/8"	5'-11 5/8"	7'-7 5/8"	7'-7 5/8"
G.S.	15 1/4"	15 1/4"	15 1/4" 35 1/4" 15 1/4"	15 1/4"	15 1/4" 55 1/4" 15 1/4"
3'-2" 3'-0 1/2" 31 1/4"	N13-13-13	N13-23-13	N13-23P-13	N13-33-13	N13-33P-13
3'-8" 3'-6 1/2" 37 1/4"	N136-136-136	N136-236-136	N136-236P-136	N136-336-136	N136-336P-136
4'-2" 4'-0 1/2" 43 1/4"	N14-14-14	N14-24-14	N14-24P-14	N14-34-14	N14-34P-14
4'-8" 4'-6 1/2" 49 1/4"	N146-146-146	N146-246-146	N146-246P-146	N146-346-146	N146-346P-146
5'-2" 5'-0 1/2" 55 1/4"	N15-15-15	N15-25-15	N15-25P-15	N15-35-15	N15-35P-15
5'-8" 5'-6 1/2" 61 1/4"	N156-156-156	N156-256-156	N156-256P-156	N156-356-156	N156-356P-156
6'-2" 6'-0 1/2" 67 1/4"	N16-16-16	N16-26-16	N16-26P-16	N16-36-16	N16-36P-16

NOTE: All measurements are nominal. Elevation charts are not to scale.

Divided lites are optional. Follow chart down from top row and across from left column to determine divided lites configurations.

If the cable support system and/or insulated platforms and support brackets are not being used, other means of proper support must be used. Add 1-11/16" to the R.O. height if an insulated platform is being used. R.O.'s for bay units without head and seat boards, typically used for walk-out applications, are different.

Some installation procedures will require a larger rough opening than noted (i.e. installations utilizing our installation clips), therefore, you may need to increase the rough opening size accordingly. Rough opening gaps may be increased up to a maximum of 1/2" on all sides and still be within good practice guidelines. For rough opening recommendations, see pg. 196.

PRODUCT CODES:

To order, add "45KW" before the product number (Ex: 45KWN16-36P-16).

U.D. = Unit Dimension • R.O. = Rough Opening • G.S. = Glass Size (Glass sizes are shown per sash)

Casements | Elevation Charts

Casements | "W" Series 45° Bay Windows

UNIT PROJECTION: 20 5/16"

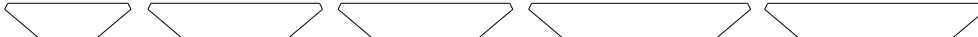

	5'-6 1/4"	7'-6 1/4"	7'-6 1/4"	9'-6 1/4"	9'-6 1/4"
U.D.	5'-6 1/4"	7'-6 1/4"	7'-6 1/4"	9'-6 1/4"	9'-6 1/4"
R.O.	5'-1 1/4"	7'-1 1/4"	7'-1 1/4"	9'-1 1/4"	9'-1 1/4"
G.S.	19 1/4"	19 1/4"	19 1/4" 43 1/4" 19 1/4"	19 1/4"	19 1/4" 67 1/4" 19 1/4"
3'-2"					
3'-0 1/2"	31 1/4"				
3'-8"					
3'-6 1/2"	37 1/4"				
4'-2"					
4'-0 1/2"	43 1/4"				
4'-8"					
4'-6 1/2"	49 1/4"				
5'-2"					
5'-0 1/2"	55 1/4"				
5'-8"					
5'-6 1/2"	61 1/4"				
6'-2"					
6'-0 1/2"	67 1/4"				

NOTE: All measurements are nominal. Elevation charts are not to scale.

Divided lites are optional.

If the cable support system and/or insulated platforms and support brackets are not being used, other means of proper support must be used. Add 1-11/16" to the R.O. height if an insulated platform is being used. R.O.'s for bay units without head and seat boards, typically used for walk-out applications, are different.

Some installation procedures will require a larger rough opening than noted (i.e. installations utilizing our installation clips), therefore, you may need to increase the rough opening size accordingly. Rough opening gaps may be increased up to a maximum of 1/2" on all sides and still be within good practice guidelines. For rough opening recommendations, see pg. 196.

PRODUCT CODES:

To order, add "45KW" before the product number (Ex: 45KWW16-36P-16).

U.D. = Unit Dimension • R.O. = Rough Opening • G.S. = Glass Size (Glass sizes are shown per sash)

Casements | "X" Series 45° Bay Windows

UNIT PROJECTION: 24 9/16"

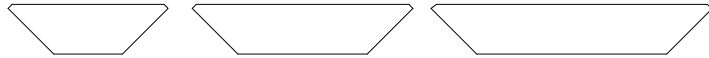

	6'-8 11/16"	9'-2 11/16"	11'-8 11/16"
U.D.	6'-8 11/16"	9'-2 11/16"	11'-8 11/16"
R.O.	6'-3 3/4"	8'-9 3/4"	11'-3 3/4"
G.S.	25 1/4"	25 1/4"	25 1/4"
3'-2"			
3'-0 1/2"	X13-13-13	X13-23-13	X13-33-13
31 1/4"			
3'-8"	X136-136-136	X136-236-136	X136-336-136
3'-6 1/2"			
37 1/4"	X14-14-14	X14-24-14	X14-34-14
4'-2"			
4'-0 1/2"	X146-146-146	X146-246-146	X146-346-146
43 1/4"			
4'-8"	X15-15-15	X15-25-15	X15-35-15
4'-6 1/2"			
49 1/4"	X156-156-156	X156-256-156	X156-356-156
5'-2"			
5'-0 1/2"	X16-16-16	X16-26-16	X16-36-16
55 1/4"			
5'-8"	X16-16-16	X16-26-16	X16-36-16
5'-6 1/2"			
61 1/4"	X16-16-16	X16-26-16	X16-36-16
6'-2"			
6'-0 1/2"	X16-16-16	X16-26-16	X16-36-16
67 1/4"	X16-16-16	X16-26-16	X16-36-16

NOTE: All measurements are nominal. Elevation charts are not to scale.

Divided lites are optional.

If the cable support system and/or insulated platforms and support brackets are not being used, other means of proper support must be used. Add 1-11/16" to the R.O. height if an insulated platform is being used. R.O.'s for bay units without head and seat boards, typically used for walk-out applications, are different.

Some installation procedures will require a larger rough opening than noted (i.e. installations utilizing our installation clips), therefore, you may need to increase the rough opening size accordingly. Rough opening gaps may be increased up to a maximum of 1/2" on all sides and still be within good practice guidelines. For rough opening recommendations, see pg. 196.

PRODUCT CODES:

To order, add "45KW" before the product number (Ex: 45KW13-13-13).

U.D. = Unit Dimension • R.O. = Rough Opening • G.S. = Glass Size (Glass sizes are shown per sash)

Casements | Elevation Charts

Casements | 90° Bay Windows

UNIT PROJECTION: 23 1/2"

	U.D.	4'-9 1/2"	4'-9 1/2"	6'-9 1/2"	6'-9 1/2"	
	R.O.	4'-0 1/2"	4'-0 1/2"	6'-0 1/2"	6'-0 1/2"	
	G.S.	19 1/4"	43 1/4"	19 1/4"	67 1/4"	
3'-2"	3'-0 1/2"	31 1/4"				
3'-8"	3'-6 1/2"	37 1/4"				
4'-2"	4'-0 1/2"	43 1/4"				
4'-8"	4'-6 1/2"	49 1/4"				
5'-2"	5'-0 1/2"	55 1/4"				
5'-8"	5'-6 1/2"	61 1/4"				
6'-2"	6'-0 1/2"	67 1/4"				

NOTE: All measurements are nominal. Elevation charts are not to scale.

Only flanker sash vent on 90° bay windows.

Divided lites are optional. Sizes and divided lite configurations for flanker sash can be found on the Casements - "S" Series chart on pg. 15.

If the cable support system and/or insulated platforms and support brackets are not being used, other means of proper support must be used. Add 1-11/16" to the R.O. height if an insulated platform is being used. R.O.'s for bay units without head and seat boards, typically used for walk-out applications, are different.

Some installation procedures will require a larger rough opening than noted (i.e. installations utilizing our installation clips), therefore, you may need to increase the rough opening size accordingly. Rough opening gaps may be increased up to a maximum of 1/2" on all sides and still be within good practice guidelines. For rough opening recommendations, see pg. 196.

PRODUCT CODES:

To order, add "90KW" before the product number (Ex: 90KWS16-W36P-S16).

U.D. = Unit Dimension • R.O. = Rough Opening • G.S. = Glass Size (Glass sizes are shown per sash)

Segment Head Casements | Single Units

U.D.	1'-6 1/2"	1'-10 1/2"	2'-2 1/2"	2'-6 1/2"	2'-8 1/2"	2'-10 1/2"	3'-2 1/2"
R.O.	1'-4 1/2"	1'-8 1/2"	2'-0 1/2"	2'-4 1/2"	2'-6 1/2"	2'-8 1/2"	3'-0 1/2"
G.S.*	11 1/4"	15 1/4"	19 1/4"	23 1/4"	25 1/4"	27 1/4"	31 1/4"
G.S.**	9 13/16"	13 13/16"	17 13/16"	21 13/16"	23 13/16"	25 13/16"	29 13/16"
2'-8"							
2'-6 1/2"							
3'-2"							
3'-0 1/2"							
3'-8"							
3'-6 1/2"							
4'-2"							
4'-0 1/2"							
4'-8"							
4'-6 1/2"							
5'-2"							
5'-0 1/2"							
5'-8"							
5'-6 1/2"							
6'-2"							
6'-0 1/2"							

NOTE: All measurements are nominal. Elevation charts are not to scale.

Divided lites are optional.

Some installation procedures will require a larger rough opening than noted (i.e. installations utilizing our installation clips), therefore, you may need to increase the rough opening size accordingly. Rough opening gaps may be increased up to a maximum of 1/2" on all sides and still be within good practice guidelines. For rough opening recommendations, see pg. 196.

* Approximate glass sizes are given; true glass sizes vary depending on the radius involved.

** Glass size for push-out casements.

*** Units meet most national emergency escape and rescue requirements.

† Push-out units are only available with single-point hardware.

PRODUCT CODES:

To order, add "KW" before the product number (Ex: KWN16-SEG). For push-out casements, have dealer specify push-out when placing order for unit. Specify stationary, left or right venting when ordering single units. Venting is viewed from the window exterior.

U.D. = Unit Dimension • R.O. = Rough Opening • G.S. = Glass Size

Casements | Elevation Charts

Segment Head Casements "S" Series

U.D.	1'-6 1/2"	2'-10 1/2"	4'-2 1/2"
R.O.	1'-4 1/2"	2'-8 1/2"	4'-0 1/2"
G.S.*	11 1/4"	11 1/4"	11 1/4"
G.S.**	9 13/16"	9 13/16"	9 13/16"
2'-8"			
3'-2"			
3'-8"			
4'-2"			
4'-8"			
5'-2"			
5'-8"			
6'-2"			

Segment Head Casements "N" Series

U.D.	1'-10 1/2"	3'-6 1/2"	5'-2 1/2"
R.O.	1'-8 1/2"	3'-4 1/2"	5'-0 1/2"
G.S.*	15 1/4"	15 1/4"	15 1/4"
G.S.**	13 13/16"	13 13/16"	13 13/16"
2'-8"			
3'-2"			
3'-8"			
4'-2"			
4'-8"			
5'-2"			
5'-8"			
6'-2"			

NOTE: All measurements are nominal. Elevation charts are not to scale.

Divided lites are optional. The divided lite configurations shown for single sash are typical for each sash of mulled units.

Some installation procedures will require a larger rough opening than noted (i.e. installations utilizing our installation clips), therefore, you may need to increase the rough opening size accordingly. Rough opening gaps may be increased up to a maximum of 1/2" on all sides and still be within good practice guidelines. For rough opening recommendations, see pg. 196.

* Approximate glass sizes per sash are given; true glass sizes vary depending on the radius involved.

** Glass size for push-out casements.

† Push-out units are only available with single-point hardware.

PRODUCT CODES: To order, add "KW" before the product number (Ex: KWS36-SEG). For push-out casements, have dealer specify push-out when placing order for unit. Specify stationary, left or right venting when ordering single units. Venting is viewed from the window exterior.

U.D. = Unit Dimension • R.O. = Rough Opening • G.S. = Glass Size (Glass sizes are shown per sash)

Segment Head Casements "W" Series

	2'-2 1/2"	4'-2 1/2"	6'-2 1/2"
U.D.	2'-2 1/2"	4'-2 1/2"	6'-2 1/2"
R.O.	2'-0 1/2"	4'-0 1/2"	6'-0 1/2"
G.S.*	19 1/4"	19 1/4"	19 1/4"
G.S.**	17 13/16"	17 13/16"	17 13/16"
2'-8"			
3'-2"			
3'-8"			
4'-2"			
4'-8"			
5'-2"			
5'-8"			
6'-2"			

Segment Head Casements "L" Series

	2'-6 1/2"	4'-10 1/2"	7'-2 1/2"
U.D.	2'-6 1/2"	4'-10 1/2"	7'-2 1/2"
R.O.	2'-4 1/2"	4'-8 1/2"	7'-0 1/2"
G.S.*	23 1/4"	23 1/4"	23 1/4"
G.S.**	21 13/16"	21 13/16"	21 13/16"
2'-8"			
3'-2"			
3'-8"			
4'-2"			
4'-8"			
5'-2"			
5'-8"			
6'-2"			

NOTE: All measurements are nominal. Elevation charts are not to scale.

Divided lites are optional. The divided lite configurations shown for single sash are typical for each sash of mulled units.

Some installation procedures will require a larger rough opening than noted (i.e. installations utilizing our installation clips), therefore, you may need to increase the rough opening size accordingly. Rough opening gaps may be increased up to a maximum of 1/2" on all sides and still be within good practice guidelines. For rough opening recommendations, see pg. 196.

* Approximate glass sizes per sash are given; true glass sizes vary depending on the radius involved.

** Glass size for push-out casements.

† Push-out units are only available with single-point hardware.

PRODUCT CODES: To order, add "KW" before the product number (Ex: W24-SEG). For push-out casements, have dealer specify push-out when placing order for unit. Specify stationary, left or right venting when ordering single units. Venting is viewed from the window exterior.

U.D. = Unit Dimension • R.O. = Rough Opening • G.S. = Glass Size (Glass sizes are shown per sash)

Casements | Elevation Charts

Segment Head Casements "X" Series

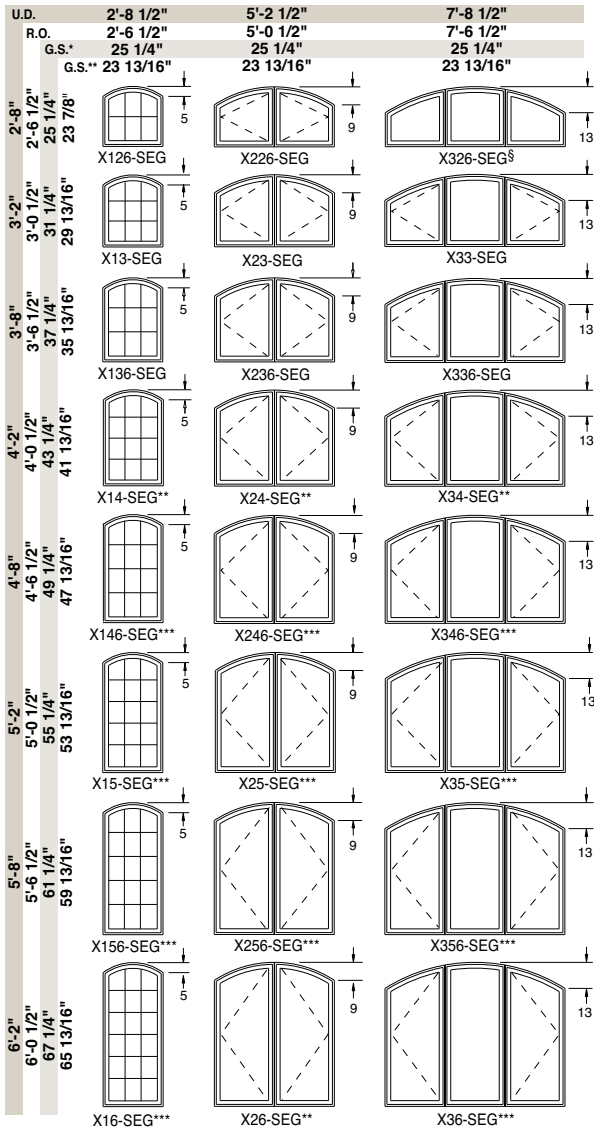

Segment Head Casements "C" Series

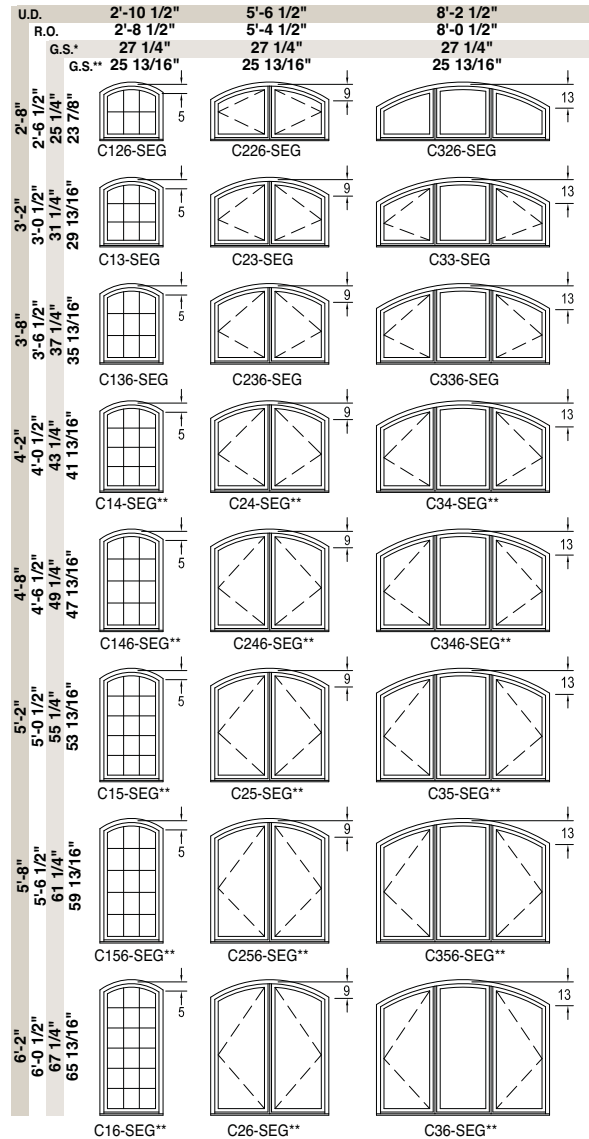

NOTE: All measurements are nominal. Elevation charts are not to scale.

Divided lites are optional. The divided lite configurations shown for single sash are typical for each sash of mullied units.

Some installation procedures will require a larger rough opening than noted (i.e. installations utilizing our installation clips), therefore, you may need to increase the rough opening size accordingly. Rough opening gaps may be increased up to a maximum of 1/2" on all sides and still be within good practice guidelines. For rough opening recommendations, see pg. 196.

* Approximate glass sizes per sash are given; true glass sizes vary depending on the radius involved.

** Glass size for push-out casements.

*** Units meet most national emergency escape and rescue requirements.





















† Push-out units are only available with single-point hardware.

§ Only available as stationary units.

PRODUCT CODES: To order, add "KW" before the product number (Ex: E16-SEG). For push-out casements, have dealer specify push-out when placing order for unit. Specify stationary, left or right venting when ordering single units. Venting is viewed from the window exterior.

U.D. = Unit Dimension • R.O. = Rough Opening • G.S. = Glass Size (Glass sizes are shown per sash)

Segment Head Casements “E” Series

U.D.	3'-2 1/2"	6'-2 1/2"	9'-2 1/2"
R.O.	3'-0 1/2"	6'-0 1/2"	9'-0 1/2"
G.S.*	31 1/4"	31 1/4"	31 1/4"
G.S.**	29 13/16"	29 13/16"	29 13/16"
3'-2"			
3'-8"			
4'-2"			
4'-8"			
5'-2"			
5'-8"			
6'-2"			

NOTE: All measurements are nominal. Elevation charts are not to scale.

Divided lites are optional. The divided lite configurations shown for single sash are typical for each sash of mullied units.

Some installation procedures will require a larger rough opening than noted (i.e. installations utilizing our installation clips), therefore, you may need to increase the rough opening size accordingly. Rough opening gaps may be increased up to a maximum of 1/2" on all sides and still be within good practice guidelines. For rough opening recommendations, see pg. 196.

* Approximate glass sizes per sash are given; true glass sizes vary depending on the radius involved.

** Glass size for push-out casements.

† Units meet most national emergency escape and rescue requirements.

§ Only available as stationary units.

PRODUCT CODES:

To order, add "KW" before the product number (Ex: E16-SEG). For push-out casements, have dealer specify push-out when placing order for unit. Specify stationary, left or right venting when ordering single units. Venting is viewed from the window exterior.

U.D. = Unit Dimension • R.O. = Rough Opening • G.S. = Glass Size (Glass sizes are shown per sash)

Casements | Elevation Charts

Segment Head Casements | Picture Units

U.D.	3'-6 1/2"	4'-2 1/2"	4'-8 1/2"	5'-2 1/2"	6'-2 1/2"
R.O.	3'-4 1/2"	4'-0 1/2"	4'-6 1/2"	5'-0 1/2"	6'-0 1/2"
G.S.*	35 1/4"	43 1/4"	49 1/4"	55 1/4"	67 1/4"
G.S.**	33 13/16"	41 13/16"	47 13/16"	53 13/16"	65 13/16"
1'-6"	N214P-SEG	W214P-SEG	4614P-SEG	N314P-SEG	W314P-SEG
1'-10"	N218P-SEG	W218P-SEG	4618P-SEG	N318P-SEG	W318P-SEG
2'-2"	N22P-SEG	W22P-SEG	4620P-SEG	N32P-SEG	W32P-SEG
2'-8"	N226P-SEG	W226P-SEG	4626P-SEG	N326P-SEG	W326P-SEG
3'-2"	N23P-SEG	W23P-SEG	4630P-SEG	N33P-SEG	W33P-SEG
3'-8"	N236P-SEG	W236P-SEG	4636P-SEG	N336P-SEG	W336P-SEG
4'-2"	N24P-SEG	W24P-SEG	4640P-SEG	N34P-SEG	W34P-SEG
4'-8"	N246P-SEG	W246P-SEG	4646P-SEG	N346P-SEG	W346P-SEG
5'-2"	N25P-SEG	W25P-SEG	4650P-SEG	N35P-SEG	W35P-SEG
5'-8"	N256P-SEG	W256P-SEG	4656P-SEG	N356P-SEG	W356P-SEG
6'-2"	N26P-SEG	W26P-SEG	4660P-SEG	N36P-SEG	W36P-SEG

NOTE: All measurements are nominal. Elevation charts are not to scale.

Divided lites are optional. Follow down from top row and across from left column to determine divided lite configurations.

Some installation procedures will require a larger rough opening than noted (i.e. installations utilizing our installation clips), therefore, you may need to increase the rough opening size accordingly. Rough opening gaps may be increased up to a maximum of 1/2" on all sides and still be within good practice guidelines. For rough opening recommendations, see pg. 196.

* Approximate glass sizes are given; true glass sizes vary depending on the radius involved.

** Glass size for units to match operating push-out casements.

PRODUCT CODES:

To order, add "KW" before the product number (Ex: 4636P-SEG). If unit is to be mullied with a push-out casement, have dealer specify push-out when placing order for unit.

U.D. = Unit Dimension • R.O. = Rough Opening • G.S. = Glass Size

Half-Circle Top Casements

U.D.	1'-6 1/2"	1'-10 1/2"	2'-2 1/2"	2'-6 1/2"	2'-8 1/2"	2'-10 1/2"	3'-2 1/2"
R.O.	1'-4 1/2"	1'-8 1/2"	2'-0 1/2"	2'-4 1/2"	2'-6 1/2"	2'-8 1/2"	3'-0 1/2"
G.S.*	11 1/4"	15 1/4"	19 1/4"	23 1/4"	25 1/4"	27 1/4"	31 1/4"
G.S.**	9 13/16"	13 13/16"	17 13/16"	21 13/16"	23 13/16"	25 13/16"	29 13/16"
2'-8"							
3'-2"							
3'-8"							
4'-2"							
4'-8"							
5'-2"							
5'-8"							
6'-2"							

NOTE: All measurements are nominal. Elevation charts are not to scale.

Units are stationary as standard, however, some may be ordered as venting units. Contact your local dealer for details.

Divided lites are optional.

Some installation procedures will require a larger rough opening than noted (i.e. installations utilizing our installation clips), therefore, you may need to increase the rough opening size accordingly. Rough opening gaps may be increased up to a maximum of 1/2" on all sides and still be within good practice guidelines. For rough opening recommendations, see pg. 196.

* Approximate glass sizes are given; true glass sizes vary depending on the radius involved.

** Glass size for push-out casements.

*** Units meet most national emergency escape and rescue requirements when ordered as venting units.

† Push-out units are only available with single-point hardware.

PRODUCT CODES:

To order, add "KW" before the product number (Ex: L15-HC). For push-out casements, have dealer specify push-out when placing order for unit.

U.D. = Unit Dimension • R.O. = Rough Opening • G.S. = Glass Size

Casements | Cross Section Drawings

Crank-Out Casement

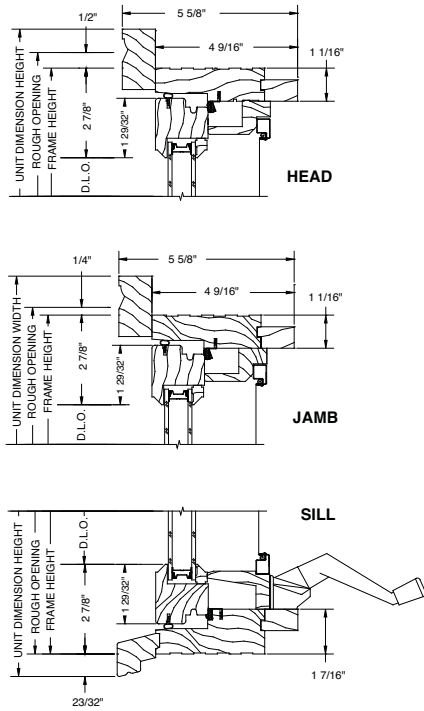

French Casement

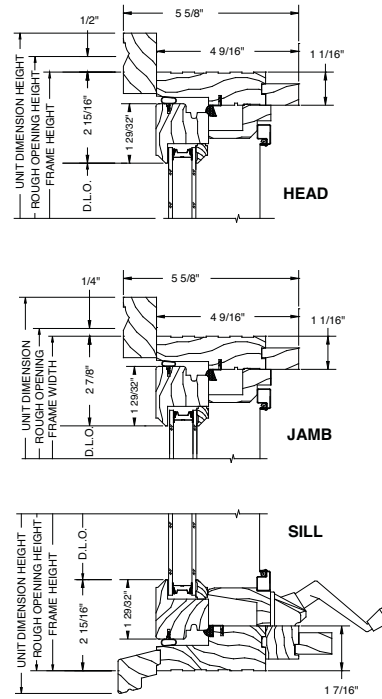

Wood Meeting Stiles

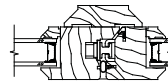

Crank-Out Casement Standard Mullion

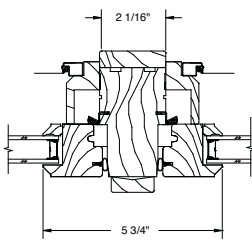

Crank-Out Casement Narrow Mullion

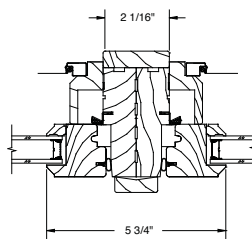

Rectangular Transoms Stacked over Crank-Out Casement

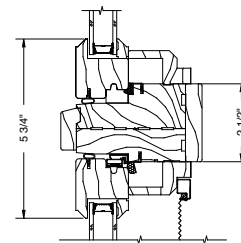

NOTE: Drawings are not to scale. Segment head and half-circle top casement drawings are similar to standard casement drawings shown. Additional and the most current drawings are available in the Architect Library at www.kolbe-kolbe.com.

Push-Out Casement

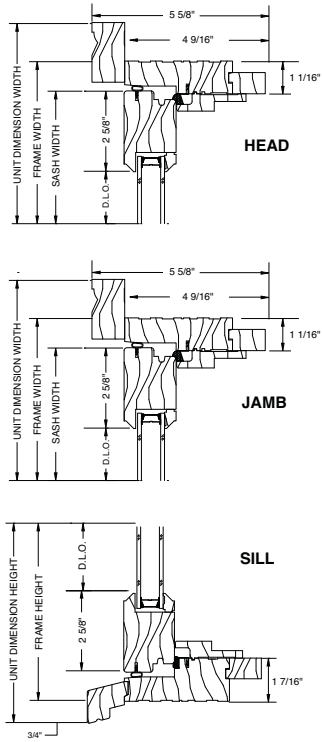

French Push-Out Casement

Horizontal Section

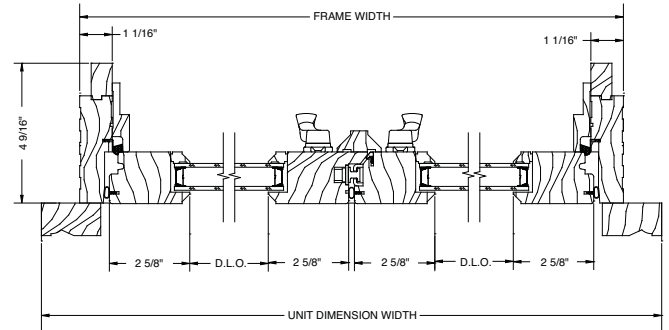

Vertical Section

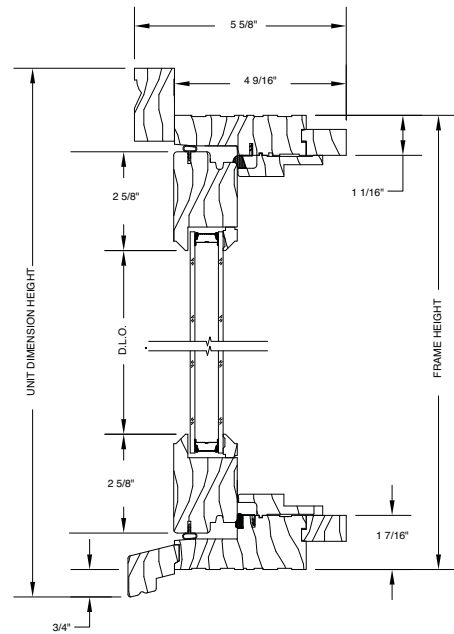

Push-Out Casement Standard Mullion

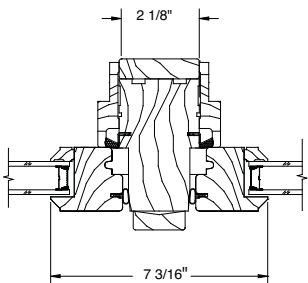

Push-Out Casement Narrow Mullion

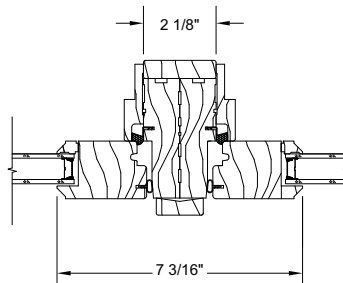

Rectangular Transom Stacked over Push-Out Casement

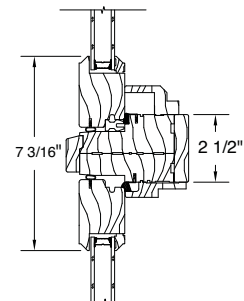

NOTE: Drawings are not to scale. Segment head and half-circle top casement drawings are similar to standard casement drawings shown. Additional and the most current drawings are available in the Architect Library at www.kolbe-kolbe.com.

Casements | Cross Section Drawings

Inswing Casement

Horizontal Section

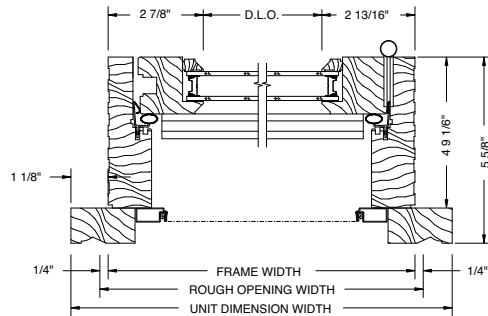

Vertical Section

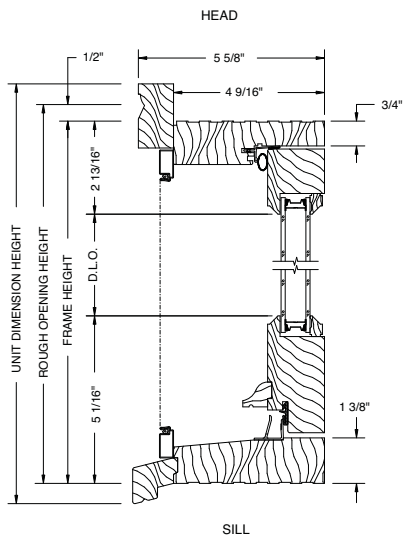

Two-Wide French Horizontal Section

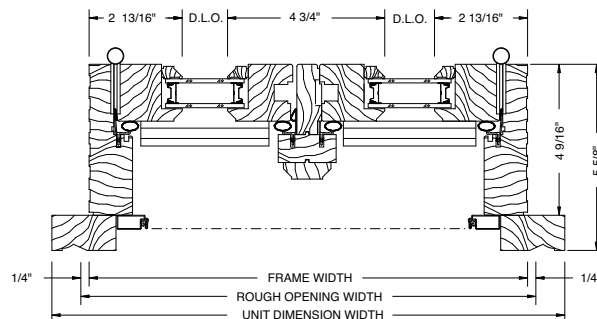

NOTE: Drawings are not to scale. Additional and the most current drawings are available in the Architect Library at www.kolbe-kolbe.com.

Casement Bay Window

30° Horizontal Section

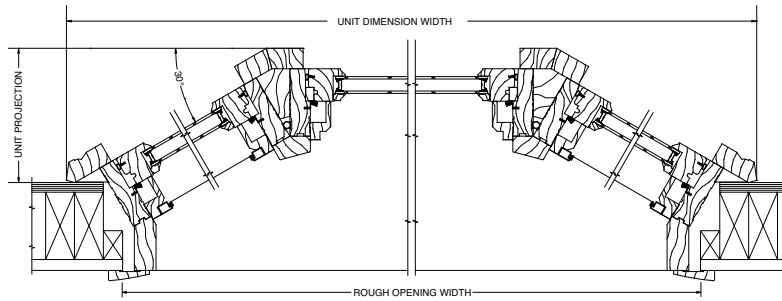

45° Horizontal Section

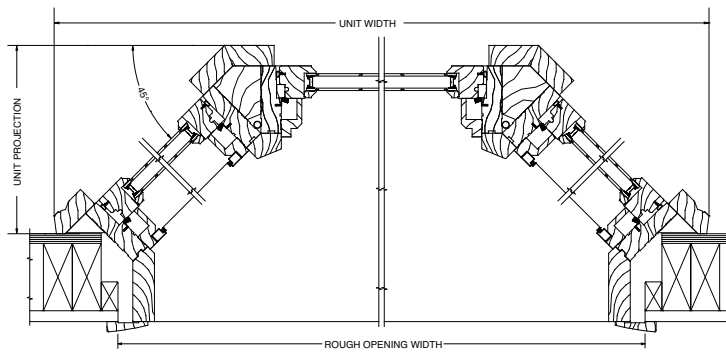

90° Horizontal Section

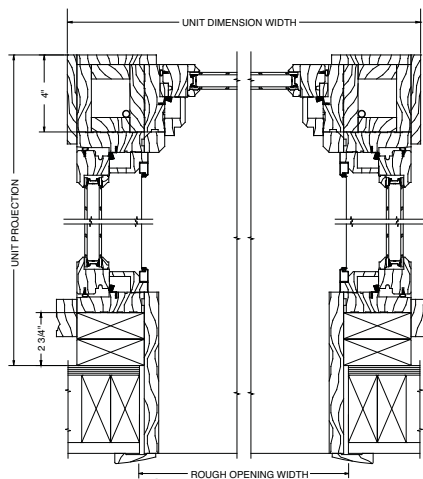

NOTE: Drawings are not to scale. Casement bay vertical drawings are similar to casement bow vertical drawings. See the following page for casement bow window drawings. Additional and the most current drawings are available in the Architect Library at www.kolbe-kolbe.com.

Casements | Cross Section Drawings

Casement Bow Window

Horizontal Section

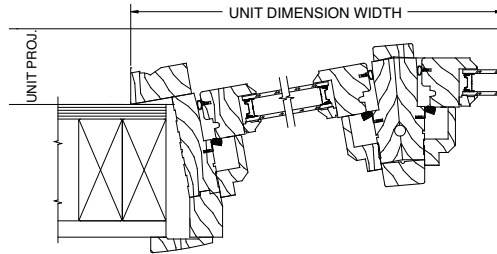

Vertical Section

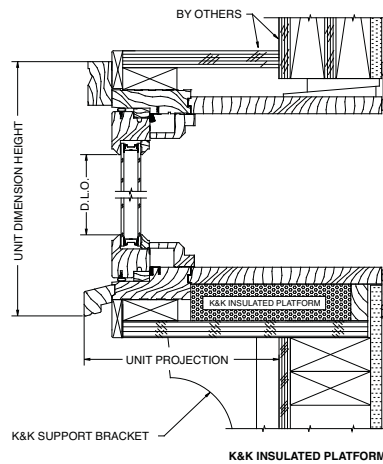

NOTE: Drawings are not to scale. Casement bay vertical drawings are similar to casement bow vertical drawings. Additional and the most current drawings are available in the Architect Library at www.kolbe-kolbe.com.





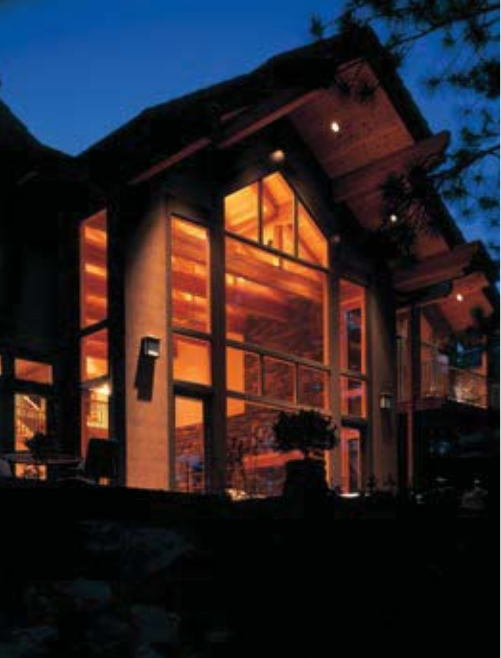

Awnings

Operating outward from the bottom, Heritage Series awning windows offer ventilation while keeping the exterior elements at bay. Their versatility can also create architectural interest in small space. Combined with awning picture windows, awnings can help to create a room with plenty of natural light and a terrific view.

*Awnings | Push-out Awnings | Picture Units | Picture Combination Units
Mulled Configurations*



Crank-Out Awnings



Crank-out awnings open out from the bottom with a crank handle that folds down when not in use. Choose motorized operators for an effortless way to open and close your window, especially if it's in a hard-to-reach place.

Crank-Out Awning Standard Features

- ▶ 1-3/4" thick sash
- ▶ Overall jamb width is 4-9/16" (*basic box width is 3-1/2"*)
- ▶ Constructed of pine, with pine interior stops and wood mull casings on mullied units
- ▶ Energy efficient, insulating LoE²-270 glass
- ▶ Glazed to the interior with beveled wood glazing beads
- ▶ 1-15/16" exterior brickmould applied
- ▶ All exterior wood parts are preservative-treated
- ▶ Exterior frame and sash are latex primed
- ▶ Fully weatherstripped for a tight seal
- ▶ Interior screens with Clay-colored aluminum frames and BetterVue[®] fiberglass mesh
- ▶ Clay-colored folding handles, operator covers and multi-point locks
- ▶ Folding corrosion resistant operators with concealed, adjustable hinges

NOTE: All measurements are nominal.

1-15/16" brickmould applied as standard

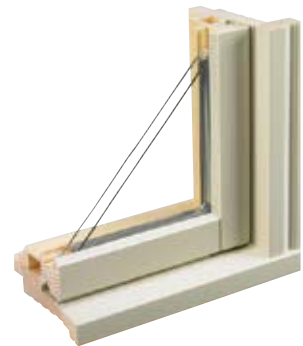

Hardware

Clay-colored, folding handles are applied to crank-out awning units as standard. Other finishes available are White, Beige, Brass, Antique Brass, Satin Nickel, Antique Nickel, Rustic Umber, and Matte Black. Multi-point lock handles will match operator handle colors.



folding handle in Clay (closed)

folding handle in Clay (open)

Multi-Point Lock

Heritage Series crank-out awnings feature a multi-point locking system as standard, which quickly and securely locks units from one convenient location. A sleek, slim-line handle and escutcheon makes windows more attractive. Handles and escutcheons are Clay as standard. Other finishes available are White, Beige, Brass, Antique Brass, Satin Nickel, Antique Nickel, Rustic Umber, and Matte Black finishes.



NOTE: Not available on units with a box size smaller than 1' 4".



Crank-Out Awning Optional Features

Glass (pgs. 184-185):

- ▶ LoE-180
- ▶ LoE² -240
- ▶ LoE³ -366
- ▶ ThermaPlus™ LoE
- ▶ Patterned, bronze- or gray-lite
- ▶ Tempered or laminated
- ▶ Other options standard to the industry

Divided Lites (pgs. 186-187):

- ▶ Performance divided lites with 5/8", 7/8", 1-1/8", 1-3/4", 2-1/4", or 4-1/2" bars
- ▶ True divided lites with 5/8" LoE² insulating glass and 1-1/8" bars
- ▶ Grilles-in-the-air-space
- ▶ Interior removable wood grilles with 7/8" or 1-1/8" bars and full surrounds

Exterior Finishes (pg. 189):

- ▶ K-Kron II exterior paint finish

Other Options: (custom options are also available)

- ▶ Other wood species and FSC-certified wood (pg. 188)
- ▶ Interior prefinishing (pg. 188)
- ▶ Interior casing (pg. 190)
- ▶ Prep for stool

- ▶ 3-1/2" flat or profiled brickmould, backband on 3-1/2" brickmould and other custom millwork (pg. 190)
- ▶ Projected sill nosing, extended sill horns or no nosing
- ▶ Ovolo and square profile glazing beads and interior divided lite bars (pg. 192)
- ▶ Operator covers, handles and multi-point locks in White, Beige, Brass, Antique Brass, Satin Nickel, Antique Nickel, Rustic Umber, and Matte Black finishes. Oil-Rubbed* finish is available upon request.
- ▶ Universal design awning handle and lock in White or Clay
- ▶ Motorized window system
- ▶ Screens with White, Beige, Brass, Dark Bronze Anodized, Clear Anodized, and Coal Black frames (Brass frames are not available on radius top units)
- ▶ Screens with aluminum or UltraVue® fiberglass mesh (not available with brass frames)
- ▶ Wood wrapped screens
- ▶ Retractable screen kit (pg. 191)
- ▶ Retractable screen covers available as beveled (standard) or square
- ▶ Extension jambs (up to 12" applied; over 12" shipped loose for field application)
- ▶ Galvanized steel installation clips
- ▶ High performance or K-Force® impact performance modifications

NOTE: All measurements are nominal.

*The Oil-Rubbed finish is a living finish, which means that it will change appearance over time with use.

Push-out Awnings



The exceedingly simple operation of push-out awning windows makes them ideal for adding ventilation to any room. The sash pushes out and pulls in tightly to the frame. Weather-stripping prevents air infiltration, making them another great energy-efficient option.

Push-Out Awning Standard Features

- ▶ 1-3/4" thick sash
- ▶ Overall jamb width is 4-9/16" (*basic box width is 3-1/2" on wood units, plus extensions*)
- ▶ Constructed of pine, with pine interior stops and wood mull casings on mullied units
- ▶ Energy efficient, insulating LoE²-270 glass
- ▶ Glazed to the interior with beveled wood glazing beads
- ▶ 1-15/16" exterior brickmould applied
- ▶ All exterior wood parts are preservative-treated
- ▶ Exterior frame and sash are latex primed
- ▶ Fully weatherstripped for a tight seal
- ▶ Single-point lever handle in an Oil-Rubbed* finish
- ▶ Concealed hinges (*segment head and half-circle top units use Tri-Euro hinges for added support*)

NOTE: All measurements are nominal.

Hardware

Push-out awning handles are single-point in an Oil-Rubbed* finish as standard. Other finishes available include Natural Brass and Satin Nickel. Multi-point handles are also available in Natural Brass, Satin Nickel, or Oil-Rubbed.*

* The Oil-Rubbed finish is a living finish, which means that it will change appearance over time with use.





Push-Out Awning Optional Features

Glass (pgs. 184-185):

- ▶ LoE-180
- ▶ LoE² -240
- ▶ LoE³ -366
- ▶ ThermaPlus™ LoE
- ▶ Patterned, bronze- or gray-lite
- ▶ Tempered or laminated
- ▶ Other options standard to the industry

Divided Lites (pgs. 186-187):

- ▶ Performance divided lites with 5/8", 7/8", 1-1/8", 1-3/4", 2-1/4", or 4-1/2" bars
- ▶ True divided lites with 5/8" LoE² insulating glass and 1-1/8" bars
- ▶ Grilles-in-the-air-space
- ▶ Interior removable wood grilles with 7/8" or 1-1/8" bars and full surrounds

Exterior Finishes (pg. 189):

- ▶ K-Kron II exterior paint finish

Other Options: (custom options are also available)

- ▶ Other wood species and FSC-certified wood (pg. 188)
- ▶ Interior prefinishing (pg. 188)

NOTE: All measurements are nominal.

*The Oil-Rubbed finish is a living finish, which means that it will change appearance over time with use.

- ▶ Interior casing (pg. 190)
- ▶ Prep for stool
- ▶ 3-1/2" flat or profiled brickmould, backband on 3-1/2" brickmould and other custom millwork (pg. 190)
- ▶ Projected sill nosing, extended sill horns or no nosing
- ▶ Ovolo and square profile glazing beads and interior divided lite bars (pg. 192)
- ▶ Multi-point handles in Oil-Rubbed,* Natural Brass or Satin Nickel finishes
- ▶ Wood frame hinged/swinging screen or retractable screen with BetterVue® fiberglass mesh (segment head and half-circle top casements are only available with a hinged/swinging screen)
- ▶ Retractable screen covers available as beveled (standard) or square
- ▶ Screens with UltraVue® fiberglass mesh (hinged/swinging screen only)
- ▶ Extension jambs (up to 12" applied; over 12" shipped loose for field application)
- ▶ Galvanized steel installation clips
- ▶ High performance or K-Force® impact performance modifications

Awnings | Elevation Charts

Awnings | Single Units

U.D.	2'-2 1/2"	2'-8 1/2"	2'-10 1/2"	3'-2 1/2"	3'-8 1/2"	4'-2 1/2"
R.O.	2'-0 1/2"	2'-6 1/2"	2'-8 1/2"	3'-0 1/2"	3'-6 1/2"	4'-0 1/2"
G.S.	19 1/4"	25 1/4"	27 1/4"	31 1/4"	37 1/4"	43 1/4"
G.S.	17 13/16"	23 13/16"	25 13/16"	29 13/16"	35 13/16"	41 13/16"
1'-10"						
2'-2"	2018	2618	2818	3018	3618	4018
2'-0 1/2"						
2'-6 1/2"	2020	2620	2820	3020	3620	4020
2'-8"						
2'-10 1/2"	2026	2626	2826	3026	3626	4026
3'-2"						
3'-0 1/2"	2030	2630	2830	3030	3630	4030

Awnings | Single Picture Units

U.D.	2'-2 1/2"	2'-8 1/2"	2'-10 1/2"	3'-2 1/2"	3'-8 1/2"	4'-2 1/2"
R.O.	2'-0 1/2"	2'-6 1/2"	2'-8 1/2"	3'-0 1/2"	3'-6 1/2"	4'-0 1/2"
G.S.	19 1/4"	25 1/4"	27 1/4"	31 1/4"	37 1/4"	43 1/4"
G.S.	17 13/16"	23 13/16"	25 13/16"	29 13/16"	35 13/16"	41 13/16"
4'-2"						
4'-0 1/2"	2040	2640	2840	3040	3640	4040
5'-2"						
5'-0 1/2"	2050	2650	2850	3050	3650	4050
6'-2"						
6'-0 1/2"	2060	2660	2860	3060	3660	4060

Dimension Calculations

Elevation charts provide wood unit dimensions with the standard 1 15/16" brickmould. Below are the calculations to determine the frame size of units with brickmould.

	Width	Height
1-15/16" brickmould; U.D. to F.S.	-2 1/2"	-2"
3-1/2" flat or profiled casing; U.D. to F.S.	-5 5/8"	-3 9/16"
3-1/2" casing and backband; U.D. to F.S.	-7 1/8"	-4 5/16"

F.S. to Sash O.S.M.	-1 15/16"	-1 15/16"
Sash O.S.M. to G.S.	-2 13/16"	-2 13/16"
G.S. to D.L.O.	-1"	-1"
G.S. to Screen O.S.M.	+1 9/16"	+1/2"
U.D. to G.S. (for push-outs)	-8 11/16"	-8 3/16"

F.S. = Frame Size • G.S. = Glass Size • O.S.M. = Outside Measurement
D.L.O. = Daylight Opening • U.D. = Unit Dimension

NOTE: All measurements are nominal. Elevation charts are not to scale.

Divided lites are optional.

Some installation procedures will require a larger rough opening than noted (i.e. installations utilizing our installation clips), therefore, you may need to increase the rough opening size accordingly. Rough opening gaps may be increased up to a maximum of 1/2" on all sides and still be within good practice guidelines. For rough opening recommendations, see pg. 196.

* Glass size for push-out awnings

PRODUCT CODES:

To order single units, add "KW" before the product number and number "1" after (Ex: KW40301). For push-out awnings, have dealer specify push-out when placing order for unit.

U.D. = Unit Dimension • R.O. = Rough Opening • G.S. = Glass Size

Awning Units & Mull Configurations

2' 0" widths

U.D.	2'-2 1/2"	4'-2 1/2"	6'-2 1/2"
R.O.	2'-0 1/2"	4'-0 1/2"	6'-0 1/2"
G.S.	19 1/4"	19 1/4"	19 1/4"
G.S.*	17 13/16"	17 13/16"	17 13/16"
1'-6"			
2'-10"			
4'-2"			
1'-8"			
3'-2"			
4'-8"			
1'-10"			
3'-6"			
5'-2"			
2'-2"			
4'-2"			
6'-2"			
2'-8"			
5'-2"			
3'-2"			
6'-2"			
4'-2"			
8'-2"			

Awning Picture Units

2' 0" widths

U.D.	2'-2 1/2"	4'-2 1/2"	6'-2 1/2"
R.O.	2'-0 1/2"	4'-0 1/2"	6'-0 1/2"
G.S.	19 1/4"	19 1/4"	19 1/4"
G.S.*	17 13/16"	17 13/16"	17 13/16"
4'-2"			
5'-2"			
6'-2"			

Awning Unit Combinations

2' 0" widths

U.D.	2'-2 1/2"	4'-2 1/2"	6'-2 1/2"
R.O.	2'-0 1/2"	4'-0 1/2"	6'-0 1/2"
G.S.	19 1/4"	19 1/4"	19 1/4"
G.S.*	17 13/16"	17 13/16"	17 13/16"
4'-10"			
5'-2"			
5'-10"			
6'-2"			
6'-10"			

NOTE: All measurements are nominal. Elevation charts are not to scale.

Divided lites are optional.

Some installation procedures will require a larger rough opening than noted (i.e. installations utilizing our installation clips), therefore, you may need to increase the rough opening size accordingly. Rough opening gaps may be increased up to a maximum of 1/2" on all sides and still be within good practice guidelines. For rough opening recommendations, see pg. 196.

* Glass size for push-out awnings

PRODUCT CODES:

To order single units, add "KW" before the product number and number "1" after (Ex: KW40301). For push-out awnings, have dealer specify push-out when placing order for unit.

U.D. = Unit Dimension • R.O. = Rough Opening • G.S. = Glass Size

Awnings | Elevation Charts

Awning Units & Mull Configurations

2' 6" widths

U.D.	2'-8 1/2"	5'-2 1/2"	7'-8 1/2"
R.O.	2'-6 1/2"	5'-0 1/2"	7'-6 1/2"
G.S.	25 1/4"	25 1/4"	25 1/4"
G.S.*	23 13/16"	23 13/16"	23 13/16"
1'-6"	26141	26142	26143
1'-4 1/2"	261412	261422	261432
2'-10"	261413	261423	261433
4'-2"	261413	261423	261433
4'-0 1/2"	261413	261423	261433
11 1/4"	261413	261423	261433
9 13/16"	261413	261423	261433
1'-8"	26161	26162	26163
3'-2"	261612	261622	261632
3'-0 1/2"	261613	261623	261633
4'-6 1/2"	261613	261623	261633
13 1/4"	261613	261623	261633
11 13/16"	261613	261623	261633
1'-10"	26181	26182	26183
3'-6"	261812	261822	261832
5'-2"	261813	261823	261833
5'-0 1/2"	261813	261823	261833
15 1/4"	261813	261823	261833
13 13/16"	261813	261823	261833
2'-2"	26201	26202	26203
4'-2"	262012	262022	262032
6'-2"	262013	262023	262033
6'-0 1/2"	262013	262023	262033
19 1/4"	262013	262023	262033
17 13/16"	262013	262023	262033
2'-8"	26261	26262	26263
5'-2"	262612	262622	262632
5'-0 1/2"	262613	262623	262633
25 1/4"	262613	262623	262633
23 13/16"	262613	262623	262633
3'-2"	26301	26302	26303
3'-0 1/2"	263012	263022	263032
6'-2"	263013	263023	263033
6'-0 1/2"	263013	263023	263033
31 1/4"	263013	263023	263033
29 13/16"	263013	263023	263033
4'-2"	26401	26402	26403
4'-0 1/2"	264012	264022	264032
8'-2"	264012	264022	264032
8'-0 1/2"	264012	264022	264032
43 1/4"	264012	264022	264032
41 13/16"	264012	264022	264032

Awning Picture Units

2' 6" widths

U.D.	2'-8 1/2"	5'-2 1/2"	7'-8 1/2"
R.O.	2'-6 1/2"	5'-0 1/2"	7'-6 1/2"
G.S.	25 1/4"	25 1/4"	25 1/4"
G.S.*	23 13/16"	23 13/16"	23 13/16"
4'-2"	26401	26402	26403
4'-0 1/2"	26401	26402	26403
43 1/4"	26401	26402	26403
41 13/16"	26401	26402	26403
5'-2"	26501	26502	26503
5'-0 1/2"	26501	26502	26503
55 1/4"	26501	26502	26503
53 13/16"	26501	26502	26503
6'-2"	26601	26602	26603
6'-0 1/2"	26601	26602	26603
67 1/4"	26601	26602	26603
65 13/16"	26601	26602	26603

Awning Unit Combinations

2' 6" widths

U.D.	2'-8 1/2"	5'-2 1/2"	7'-8 1/2"
R.O.	2'-6 1/2"	5'-0 1/2"	7'-6 1/2"
G.S.	25 1/4"	25 1/4"	25 1/4"
G.S.*	23 13/16"	23 13/16"	23 13/16"
4'-10"	2630181	2630182	2630183
4'-8 1/2"	2630181	2630182	2630183
15 1/4" 31 1/4"	2630181	2630182	2630183
15 1/4" 31 1/4"	2630181	2630182	2630183
5'-2"	2630201	2630202	2630203
5'-0 1/2"	2630201	2630202	2630203
19 1/4" 31 1/4"	2630201	2630202	2630203
17 13/16" 29 13/16"	2630201	2630202	2630203
13 13/16" 41 13/16"	2640181	2640182	2640183
13 13/16" 41 13/16"	2640181	2640182	2640183
5'-10"	2640181	2640182	2640183
5'-8 1/2"	2640181	2640182	2640183
15 1/4" 43 1/4"	2640181	2640182	2640183
13 13/16" 41 13/16"	2640181	2640182	2640183
6'-2"	2640201	2640202	2640203
6'-0 1/2"	2640201	2640202	2640203
19 1/4" 43 1/4"	2640201	2640202	2640203
17 13/16" 41 13/16"	2640201	2640202	2640203
6'-10"	2650181	2650182	2650183
6'-8 1/2"	2650181	2650182	2650183
15 1/4" 55 1/4"	2650181	2650182	2650183
13 13/16" 53 13/16"	2650181	2650182	2650183

NOTE: All measurements are nominal. Elevation charts are not to scale.

Divided lites are optional. The divided lite configuration shown for single units are typical for each sash of mullied units.

Some installation procedures will require a larger rough opening than noted (i.e. installations utilizing our installation clips), therefore, you may need to increase the rough opening size accordingly. Rough opening gaps may be increased up to a maximum of 1/2" on all sides and still be within good practice guidelines. For rough opening recommendations, see pg. 196.

* Glass size for push-out awnings

PRODUCT CODES:

To order, add "KW" before the product number (Ex: KW263032). For push-out awnings, have dealer specify push-out when placing order for unit.

U.D. = Unit Dimension • R.O. = Rough Opening • G.S. = Glass Size (Glass sizes are shown per sash)

Awning Units & Mull Configurations

2' 8" widths

U.D.	2'-10 1/2"	5'-6 1/2"	8'-2 1/2"
R.O.	2'-8 1/2"	5'-4 1/2"	8'-0 1/2"
G.S.	27 1/4"	27 1/4"	27 1/4"
G.S.*	25 13/16"	25 13/16"	25 13/16"
1'-6"			
2'-10"			
4'-2"			
1'-8"			
3'-2"			
4'-8"			
1'-10"			
3'-6"			
5'-2"			
2'-2"			
4'-2"			
6'-2"			
2'-8"			
5'-2"			
3'-2"			
6'-2"			
4'-2"			
8'-2"			

Awning Picture Units

2' 8" widths

U.D.	2'-10 1/2"	5'-6 1/2"	8'-2 1/2"
R.O.	2'-8 1/2"	5'-4 1/2"	8'-0 1/2"
G.S.	27 1/4"	27 1/4"	27 1/4"
G.S.*	25 13/16"	25 13/16"	25 13/16"
4'-2"			
5'-2"			
6'-2"			

Awning Unit Combinations

2' 8" widths

U.D.	2'-10 1/2"	5'-6 1/2"	8'-2 1/2"
R.O.	2'-8 1/2"	5'-4 1/2"	8'-0 1/2"
G.S.	27 1/4"	27 1/4"	27 1/4"
G.S.*	25 13/16"	25 13/16"	25 13/16"
4'-10"			
5'-2"			
5'-10"			
6'-2"			
6'-10"			

NOTE: All measurements are nominal. Elevation charts are not to scale.

Divided lites are optional. The divided lite configuration shown for single units are typical for each sash of mullied units.

Some installation procedures will require a larger rough opening than noted (i.e. installations utilizing our installation clips), therefore, you may need to increase the rough opening size accordingly. Rough opening gaps may be increased up to a maximum of 1/2" on all sides and still be within good practice guidelines. For rough opening recommendations, see pg. 196.

* Glass size for push-out awnings

PRODUCT CODES:

To order, add "KW" before the product number (Ex: KW263032). For push-out awnings, have dealer specify push-out when placing order for unit.

U.D. = Unit Dimension • R.O. = Rough Opening • G.S. = Glass Size (Glass sizes are shown per sash)

Awning Units & Mull Configurations

3' 0" widths

U.D.	3'-2 1/2"	6'-2 1/2"	9'-2 1/2"
R.O.	3'-0 1/2"	6'-0 1/2"	9'-0 1/2"
G.S.	31 1/4"	31 1/4"	31 1/4"
G.S.*	29 13/16"	29 13/16"	29 13/16"
1'-6"			
1'-4 1/2"			
1'-4 1/2"			
2'-10"			
2'-8 1/2"			
2'-8 1/2"			
3'-2"			
3'-0 1/2"			
3'-0 1/2"			
4'-8"			
4'-6 1/2"			
4'-6 1/2"			
6'-2"			
6'-0 1/2"			
6'-0 1/2"			
6'-0 1/2"			
8'-2"			
8'-0 1/2"			

Awning Picture Units

3' 0" widths

R.O.	3'-0 1/2"	6'-0 1/2"	9'-0 1/2"
G.S.	31 1/4"	31 1/4"	31 1/4"
G.S.*	29 13/16"	29 13/16"	29 13/16"

Awning Unit Combinations

3' 0" widths

U.D.	3'-2 1/2"	6'-2 1/2"	9'-2 1/2"
R.O.	3'-0 1/2"	6'-0 1/2"	9'-0 1/2"
G.S.	31 1/4"	31 1/4"	31 1/4"
G.S.*	29 13/16"	29 13/16"	29 13/16"

NOTE: All measurements are nominal. Elevation charts are not to scale.

Divided lites are optional. The divided lite configuration shown for single units are typical for each sash of mullied units.

Some installation procedures will require a larger rough opening than noted (i.e. installations utilizing our installation clips), therefore, you may need to increase the rough opening size accordingly. Rough opening gaps may be increased up to a maximum of 1/2" on all sides and still be within good practice guidelines. For rough opening recommendations, see pg. 196.

* Glass size for push-out awnings

PRODUCT CODES:

To order, add "KW" before the product number (Ex: KW303032). For push-out awnings, have dealer specify push-out when placing order for unit.

U.D. = Unit Dimension • R.O. = Rough Opening • G.S. = Glass Size (Glass sizes are shown per sash)

Awning Units & Mull Configurations

3' 6" widths

U.D.	3'-8 1/2"	7'-2 1/2"	10'-8 1/2"	
R.O.	3'-6 1/2"	7'-0 1/2"	10'-6 1/2"	
G.S.	37 1/4"	37 1/4"	37 1/4"	
G.S.*	35 13/16"	35 13/16"	35 13/16"	
Basic Unit 3614	1'-6"	36141	36142	36143
	1'-4 1/2"	361412	361422	361432
	1'-4 1/4"	361413	361423	361433
	9 13/16"	361413	361423	361433
Basic Unit 3616	1'-8"	36161	36162	36163
	1'-6 1/2"	361612	361622	361632
	13 1/4"	361613	361623	361633
	11 13/16"	361613	361623	361633
Basic Unit 3618	1'-10"	36181	36182	36183
	1'-8 1/2"	361812	361822	361832
	15 1/4"	361813	361823	361833
	13 13/16"	361813	361823	361833
Basic Unit 3620	2'-2"	36201	36202	36203
	2'-0 1/2"	362012	362022	362032
	19 1/4"	362013	362023	362033
	17 13/16"	362013	362023	362033
Basic Unit 3626	2'-8"	36261	36262	36263
	2'-6 1/2"	362612	362622	362632
	25 1/4"	362613	362623	362633
	23 13/16"	362613	362623	362633
Basic Unit 3630	3'-2"	36301	36302	36303
	3'-0 1/2"	363012	363022	363032
	31 1/4"	363013	363023	363033
	29 13/16"	363013	363023	363033
Basic Unit 3640	4'-2"	36401	36402	36403
	4'-0 1/2"	364012	364022	364032
	43 1/4"	364013	364023	364033
	41 13/16"	364013	364023	364033

Awning Picture Units

3' 6" widths

U.D.	3'-8 1/2"	7'-2 1/2"	10'-8 1/2"	
R.O.	3'-6 1/2"	7'-0 1/2"	10'-6 1/2"	
G.S.	37 1/4"	37 1/4"	37 1/4"	
G.S.*	35 13/16"	35 13/16"	35 13/16"	
Basic Unit 3640	4'-2"	36401	36402	36403
	4'-0 1/2"	364012	364022	364032
	41 13/16"	364013	364023	364033
Basic Unit 3650	5'-2"	36501	36502	36503
	5'-0 1/2"	365012	365022	365032
	53 13/16"	365013	365023	365033
Basic Unit 3660	6'-2"	36601	36602	36603
	6'-0 1/2"	366012	366022	366032
	65 13/16"	366013	366023	366033

Awning Unit Combinations

3' 6" widths

U.D.	3'-8 1/2"	7'-2 1/2"	10'-8 1/2"	
R.O.	3'-6 1/2"	7'-0 1/2"	10'-6 1/2"	
G.S.	37 1/4"	37 1/4"	37 1/4"	
G.S.*	35 13/16"	35 13/16"	35 13/16"	
Basic Unit 3618 over 3618	4'-10"	3630181	3630182	3630183
	4'-8 1/2"	36301812	36301822	36301832
	15 1/4" / 31 1/4"	36301813	36301823	36301833
Basic Unit 3630 over 3620	5'-2"	3630201	3630202	3630203
	5'-0 1/2"	36302012	36302022	36302032
	19 1/4" / 31 1/4"	36302013	36302023	36302033
Basic Unit 3640 over 3618	5'-10"	3640181	3640182	3640183
	5'-8 1/2"	36401812	36401822	36401832
	15 1/4" / 43 1/4"	36401813	36401823	36401833
Basic Unit 3640 over 3620	6'-2"	3640201	3640202	3640203
	6'-0 1/2"	36402012	36402022	36402032
	19 1/4" / 43 1/4"	36402013	36402023	36402033
Basic Unit 3650 over 3618	6'-10"	3650181	3650182	3650183
	6'-8 1/2"	36501812	36501822	36501832
	15 1/4" / 55 1/4"	36501813	36501823	36501833

NOTE: All measurements are nominal. Elevation charts are not to scale.

Divided lites are optional. The divided lite configuration shown for single units are typical for each sash of mullied units.

Some installation procedures will require a larger rough opening than noted (i.e. installations utilizing our installation clips), therefore, you may need to increase the rough opening size accordingly. Rough opening gaps may be increased up to a maximum of 1/2" on all sides and still be within good practice guidelines. For rough opening recommendations, see pg. 196.

* Glass size for push-out awnings

PRODUCT CODES:

To order, add "KW" before the product number (Ex: KW363032). For push-out awnings, have dealer specify push-out when placing order for unit.

U.D. = Unit Dimension • R.O. = Rough Opening • G.S. = Glass Size (Glass sizes are shown per sash)

Awnings | Elevation Charts

Awning Units & Mull Configurations 4' 0" widths

U.D.	4'-2 1/2"	8'-2 1/2"	12'-2 1/2"
R.O.	4'-0 1/2"	8'-0 1/2"	12'-0 1/2"
G.S.	43 1/4"	43 1/4"	43 1/4"
G.S.*	41 13/16"	41 13/16"	41 13/16"
Basic Unit 4014	40141	40142	40143
	401412	401422	401432
	401413	401423	401433
Basic Unit 4016	40161	40162	40163
	401612	401622	401632
	401613	401623	401633
Basic Unit 4018	40181	40182	40183
	401812	401822	401832
	401813	401823	401833
Basic Unit 4020	40201	40202	40203
	402012	402022	402032
	402013	402023	402033
Basic Unit 4026	40261	40262	40263
	402612	402622	402632
	402613	402623	402633
Basic Unit 4030	40301	40302	40303
	403012	403022	403032
	403013	403023	403033
Basic Unit 4040	40401	40402	40403
	404012	404022	404032
	404013	404023	404033

Awning Picture Units 4' 0" widths

U.D.	4'-2 1/2"	8'-2 1/2"	12'-2 1/2"
R.O.	4'-0 1/2"	8'-0 1/2"	12'-0 1/2"
G.S.	43 1/4"	43 1/4"	43 1/4"
G.S.*	41 13/16"	41 13/16"	41 13/16"
Basic Unit 4040	40401	40402	40403
	40501	40502	40503
	40601	40602	40603

Awning Unit Combinations 4' 0" widths

U.D.	4'-2 1/2"	8'-2 1/2"	12'-2 1/2"	
R.O.	4'-0 1/2"	8'-0 1/2"	12'-0 1/2"	
G.S.	43 1/4"	43 1/4"	43 1/4"	
G.S.*	41 13/16"	41 13/16"	41 13/16"	
Basic Unit 4030 over 4018	4030181	4030182	4030183	
	Basic Unit 4030 over 4020	4030201	4030202	4030203
		Basic Unit 4040 over 4018	4040181	4040182
Basic Unit 4040 over 4020			4040201	4040202
	Basic Unit 4050 over 4018		4050181	4050182

NOTE: All measurements are nominal. Elevation charts are not to scale.

Divided lites are optional. The divided lite configuration shown for single units are typical for each sash of mullied units.

Some installation procedures will require a larger rough opening than noted (i.e. installations utilizing our installation clips), therefore, you may need to increase the rough opening size accordingly. Rough opening gaps may be increased up to a maximum of 1/2" on all sides and still be within good practice guidelines. For rough opening recommendations, see pg. 196.

* Glass size for push-out awnings

PRODUCT CODES:

To order, add "KW" before the product number (Ex: KW403032). For push-out awnings, have dealer specify push-out when placing order for unit.

U.D. = Unit Dimension • R.O. = Rough Opening • G.S. = Glass Size (Glass sizes are shown per sash)

Awnings | Cross Section Drawings

Crank-Out Awning

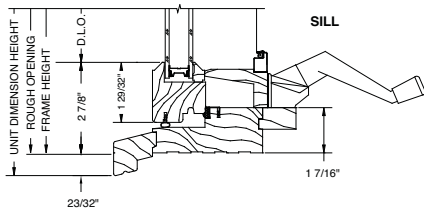
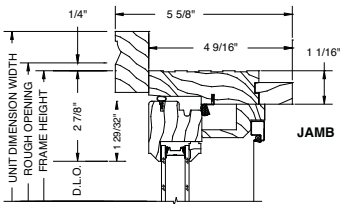
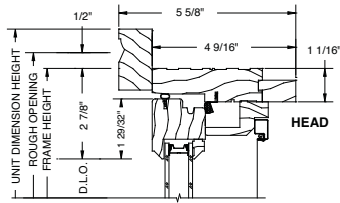

Push-out Awning

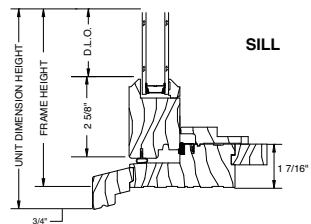
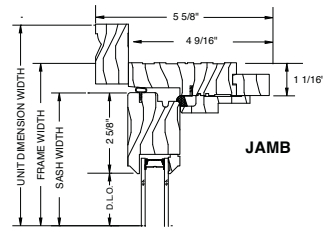
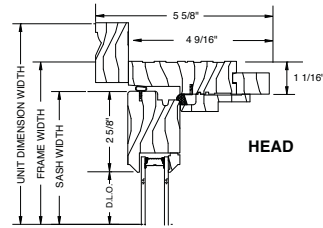

Crank-Out Awning Standard Mullion

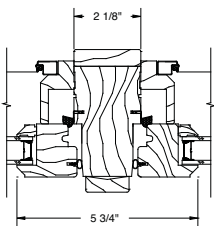

Crank-Out Awning Narrow Mullion

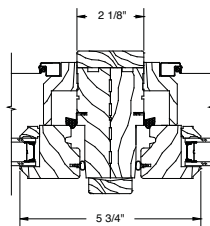

Picture Unit Stacked Over Crank-Out Awning

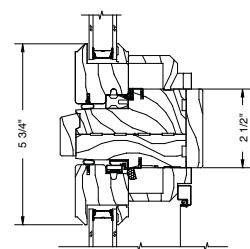

Push-out Awning Standard Mullion

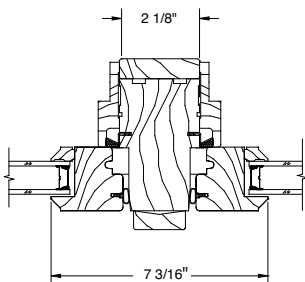

Push-out Awning Narrow Mullion

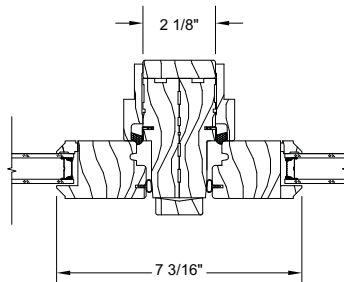

Picture Unit Stacked Over Push-out Awning

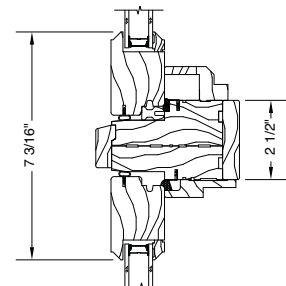

NOTE: Drawings are not to scale. Additional and the most current drawings are available in the Architect Library at www.kolbe-kolbe.com.





Double Hungs

Smooth operation, venting options, removable sash for easy cleaning, and classic styling are only the most obvious features of Heritage Series double hung windows. Kolbe offers a variety of double hung models to suit your project, whether it be residential, commercial, large scale, historic preservation or remodeling. There are many options and configurations to choose from as well, including bow and bay units, cottage-style units or triple pane glass options for increased energy efficiency.

*Sterling Double Hungs | Majesta® Double Hungs | Traditional Double Hungs
Magnum Double Hungs | Old World Classic Double Hungs
Cottage-Style & Reverse-Cottage Style | Studio & Transom Units
Picture Combination Units | Bay Units | Segment Head & Half-Circle Top Units
Single Hungs | Replacement Sash Kits*



Sterling Double Hungs

Patents 7,296,381 | 7,448,164 | 8,196,355 | 8,429,856



Sterling double hungs are made to blend seamlessly with the grandest décor. A patented interior wood cover conceals the jambliner, while giving the windows a rich, full-wood appearance. The lock system boosts performance to a level not often reached by double hung windows.

Sterling Double Hung Standard Features

- ▶ 1-3/4" thick sash
- ▶ Overall jamb width is 4-9/16" (*basic box width is 4-9/16"*)
- ▶ Frame thickness is 3/4" at side jambs and head
- ▶ Sill thickness is 1-3/16", slope is 14°
- ▶ Constructed of pine, with pine interior stops and wood mull casings on muller units
- ▶ Energy efficient, insulating LoE²-270 glass
- ▶ Glazed to the interior with beveled wood glazing beads
- ▶ 1-15/16" exterior brickmould applied
- ▶ All exterior wood parts are preservative-treated
- ▶ Exterior frame and sash are latex primed
- ▶ Wood interior head parting stop
- ▶ Fully weatherstripped for a tight seal
- ▶ Clay-colored heavy duty sash lock with a dual positioning lever allows sash to be unlocked, operated and tilted in from one location
- ▶ Spring-loaded block-and-tackle mechanical balances to carry the sash weight
- ▶ Concealed PVC jambliners
- ▶ Patented wood-wrapped jambliner closure on the interior (*unless interior is prefinished white or primed, then jambliner will be white*) and a primed, extruded aluminum jambliner closure on the exterior hides PVC jambliners
- ▶ Pine-veneered head and seat boards; unique narrow mullions on bay units



A wood wrapped jambliner closure on the interior (shown) and a primed, extruded aluminum jambliner closure on the exterior hide the PVC jambliners.



Heavy duty sash lock with dual positioning lever allows sash to be unlocked, operated, and tilted in from one location.

NOTE: All measurements are nominal.

Hardware

Sterling double hungs feature a pick resistant cam lock with a concealed locking mechanism and tilt latches installed into an interlock channel. Optional sash lift handles are available for easy operation. All double hung hardware is available in Clay (*standard*), White, Beige, Brass, Antique Brass, Satin Nickel, Antique Nickel, Rustic Umber, and Matte Black finishes.



Sash lock in Clay
(*standard*)



Square style sash lift
handle in Satin Nickel



Traditional style sash lift
handle in Matte Black



Photo courtesy of Kenneth M. Wyner Photography

Sterling Double Hung Optional Features

Glass (pgs. 184-185):

- ▶ LoE-180
- ▶ LoE²-240
- ▶ LoE³-366
- ▶ ThermaPlus™ LoE
- ▶ Patterned, bronze- or gray-lite
- ▶ Tempered or laminated
- ▶ Other options standard to the industry

Divided Lites (pgs. 186-187):

- ▶ Performance divided lites with 5/8", 7/8", 1-1/8", 1-3/4", 2-1/4", or 4-1/2" bars
- ▶ True divided lites with 5/8" LoE² insulating glass and 1-1/8" bars
- ▶ Grilles-in-the-air-space
- ▶ Interior removable wood grilles with 7/8" or 1-1/8" bars and full surrounds

Exterior Finishes (pg. 189):

- ▶ K-Kron II exterior paint finish

Other Options: (custom options are also available)

- ▶ Other wood species and FSC-certified wood (pg. 188)
- ▶ Interior prefinishing (pg. 188)
- ▶ Interior casing (pg. 190)
- ▶ Prep for stool
- ▶ 3-1/2" flat or profiled brickmould, backband on 3-1/2" brickmould and other custom millwork (pg. 190)
- ▶ Projected sill nosing, extended sill horns or no nosing

NOTE: All measurements are nominal.

- ▶ Ovolo and square profile glazing beads and interior divided lite bars (pg. 192)
- ▶ Class 5 balances available for larger units
- ▶ Sash locks in White, Beige, Brass, Antique Brass, Satin Nickel, Antique Nickel, Rustic Umber, and Matte Black finishes
- ▶ Sash lift handles in Clay, White, Beige, Brass, Antique Brass, Satin Nickel, Antique Nickel, Rustic Umber, and Matte Black finishes
- ▶ Custodial locks
- ▶ Universal design crank handle hardware kit in White
- ▶ Full or half screens with aluminum frames and options for BetterVue® or UltraVue® fiberglass screen mesh or aluminum screen mesh in either aluminum or charcoal colors; frames will match the exterior color of the unit
- ▶ Retractable screen kit (pg. 191)
- ▶ Retractable screen covers available as beveled (standard) or square
- ▶ StormGuard combination storm/screen units (pg. 191)
- ▶ Extension jambs (up to 12" applied; over 12" shipped loose for field application)
- ▶ Sash limiters for safety
- ▶ Galvanized steel installation clips
- ▶ Insulated platforms, support brackets and oak-veneered head and seat boards for bay units
- ▶ High performance and K-Force® impact performance modifications

Majesta[®] Double Hungs



Majesta double hungs are made-to-order in sizes as large as 6 feet wide by 12 feet tall to allow even larger openings in the most expansive of spaces. The balances are specially made to match the size of the window and the hardware is positioned in an easily accessible place, so this extra large window is very easy to operate.

Majesta[®] Double Hung Standard Features

- ▶ 2-1/4" thick sash
- ▶ Overall jamb width is 6-9/16" (*basic box width is 6-9/16"*)
- ▶ Frame thickness is 3/4" at side jambs and head
- ▶ Sill thickness is 1-3/16", slope is 14°
- ▶ Top rail is 3", stiles are 2-1/8", and bottom rail is 4-1/8"
- ▶ Constructed of pine with pine interior head parting stops and side stops
- ▶ Horizontal sash parts are constructed with engineered core for added strength
- ▶ Energy efficient, insulating LoE²-270 glass
- ▶ 1-15/16" exterior brickmould applied
- ▶ Exterior frame and sash are latex primed
- ▶ All exterior wood parts are preservative-treated
- ▶ Innovative, Bright Brass, heavy-duty sash locks; top lock eliminates sash drop and is located at the center of the top rail on the top sash; bottom lock is located at the center of the bottom rail on the bottom sash for operating convenience
- ▶ Class 5 balance system capable of carrying sash up to 200 lbs.
- ▶ Concealed jambliners and balance system using a wood-wrapped jambliner closure on the interior and an aluminum closure on the exterior
- ▶ Double row of heavy duty weatherstrip around all sides of the sash for a tight seal
- ▶ Innovative design secures the sash in place allowing this unit to meet ratings up to CW-PG65 for certain units.

NOTE: All measurements are nominal.

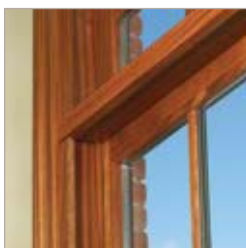

Concealed wood jambliners provide a clean look



Optional triple pane glazing for added energy efficiency

Hardware

The innovative design of the Majesta locking hardware provides both performance and security. The turn knob and locking pin on the bottom sash tightly secure the window, while the heavy duty locking hardware on the top rail of the top sash eliminates sash drop. Optional hardware includes a keyed custodial lock and sash lift handles. An optional hook and pole device to help unlock and lower the top sash is also available. All Majesta hardware is available in Brass (*standard*), Rustic Umber and Satin Nickel finishes.



Turn knob lock on the bottom rail of the bottom sash in the closed position



Turn knob and locking pin on the bottom of the bottom sash in the open position



Optional sash lift handle helps to raise the bottom sash



Heavy duty locking hardware on the top rail of the top sash



Majesta® Double Hung Optional Features

Glass (pgs. 184-185):

- ▶ LoE-180
- ▶ LoE²-240
- ▶ LoE³-366
- ▶ ThermaPlus™ LoE
- ▶ Triple pane
- ▶ Patterned, bronze- or gray-lite
- ▶ Tempered or laminated
- ▶ Other options standard to the industry

Divided Lites (pgs. 186-187):

- ▶ Performance divided lites with 5/8", 7/8", 1-1/8", 1-3/4", 2-1/4", or 4-1/2" bars
- ▶ True divided lites with 7/8" LoE² insulating glass and 1-1/8" bars
- ▶ Grilles-in-the-airspace

Exterior Finishes (pg. 189):

- ▶ K-Kron II exterior paint finish

Other Options: (custom options are also available)

- ▶ Other wood species and FSC-certified wood (pg. 188)
- ▶ Interior prefinishing (pg. 188)

NOTE: All measurements are nominal.

- ▶ Interior casing (pg. 190)
- ▶ Prep for stool
- ▶ 3-1/2" flat or profiled brickmould, backband on 3-1/2" brickmould and other custom millwork (pg. 190)
- ▶ Projected sill nosing, extended sill horns or no nosing
- ▶ Ovolo and square profile glazing beads and interior divided lite bars (pg. 192)
- ▶ Standard locks in Rustic Umber and Satin Nickel finishes
- ▶ Keyed custodial locks
- ▶ Sash lift handles (two per sash) will match other hardware
- ▶ Hook pole device to help unlock and lower the top sash
- ▶ Half screens with BetterVue® fiberglass screen mesh and aluminum frames that match the exterior color of the unit
- ▶ Sash limiters for safety
- ▶ Extension jambs (up to 12" applied; over 12" shipped loose for field application)
- ▶ Galvanized steel installation clips

Traditional Double Hungs



Kolbe's traditional double hungs are a beautifully modern version of a classic style. The sloped sill creates a traditional appearance and helps guard against water damage. Kolbe's traditional double hungs open and close smoothly and effortlessly, and the sash can be tilted in or removed for easy cleaning.

Traditional Double Hung Standard Features

- ▶ 1-3/8" thick sash
- ▶ Overall jamb width is 4-9/16" (*basic box width is 4-9/16"*)
- ▶ Frame thickness is 3/4" at side jambs and head
- ▶ Sill thickness is 1-3/16", slope is 14°
- ▶ Constructed of pine, with pine interior stops and wood mull casings on mull units
- ▶ Energy efficient, insulating LoE²-270 glass
- ▶ Glazed to the interior with beveled wood glazing beads
- ▶ 1-15/16" exterior brickmould applied
- ▶ All exterior wood parts are preservative-treated
- ▶ Exterior frame and sash are latex primed
- ▶ Rigid PVC head parting stop with flexible fins and waterseal at the sill
- ▶ Fully weatherstripped for a tight seal
- ▶ Clay-colored heavy duty sash lock
- ▶ Machined finger grooves on the top rail of the upper sash and bottom rail of the lower sash
- ▶ Spring-loaded block-and-tackle mechanical balances to carry the sash weight
- ▶ Beige PVC jambliners with compression foam backing
- ▶ Pine-veneered head and seat boards; unique narrow mullions and cable support system on bay units

NOTE: All measurements are nominal.

1-15/16" brickmould applied as standard



Hardware

Clay-colored cam locks are factory-applied to Traditional double hung units as standard. Other finishes available are White, Beige, Brass, Antique Brass, Satin Nickel, Antique Nickel, Rustic Umber, Oil-Rubbed,* and Matte Black. For units without finger grooves, sash lift handles in Clay, White, Beige, Brass, Antique Brass, Satin Nickel, Antique Nickel, Rustic Umber, and Matte Black finishes are available.

*The Oil-Rubbed finish is a living finish, which means that it will change appearance over time with use.



Sash lock in Clay
(standard)



Square style sash lift
handle in Satin Nickel



Traditional style sash lift
handle in Matte Black

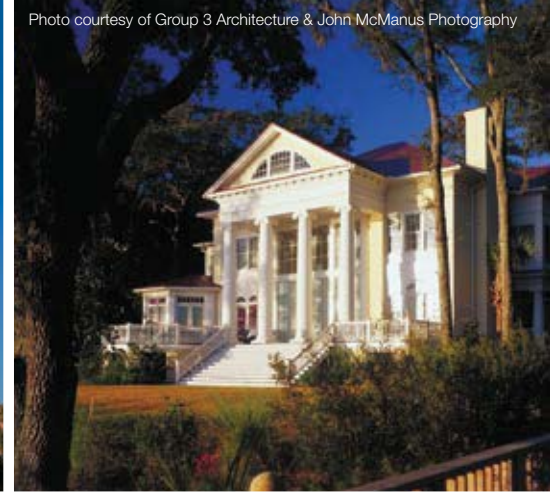

Traditional Double Hung Optional Features

Glass (pgs. 184-185):

- ▶ LoE-180
- ▶ LoE²-240
- ▶ LoE³-366
- ▶ ThermaPlus™ LoE
- ▶ Patterned, bronze- or gray-lite
- ▶ Tempered or laminated
- ▶ Other options standard to the industry

Divided Lites (pgs. 186-187):

- ▶ Performance divided lites with 5/8", 7/8", 1-1/8", 1-3/4", 2-1/4", or 4-1/2" bars
- ▶ True divided lites with 1/2" LoE² insulating glass and 1-1/8" bars
- ▶ Grilles-in-the-airSPACE
- ▶ Interior removable wood grilles with 7/8" or 1-1/8" bars and full surrounds

Exterior Finishes (pg. 189):

- ▶ K-Kron II exterior paint finish

Other Options: (custom options are also available)

- ▶ Other wood species and FSC-certified wood (pg. 188)
- ▶ Interior prefinishing (pg. 188)
- ▶ Interior casing (pg. 190)
- ▶ Prep for stool

NOTE: All measurements are nominal.

*The Oil-Rubbed finish is a living finish, which means that it will change appearance over time with use.

- ▶ 3-1/2" flat or profiled brickmould, backband on 3-1/2" brickmould and other custom millwork (pg. 190)
- ▶ Projected sill nosing, extended sill horns or no nosing
- ▶ Ovolo and square profile glazing beads and interior divided lite bars (pg. 192)
- ▶ No finger grooves in top, bottom or both sash
- ▶ Sash locks in White, Beige, Brass, Antique Brass, Satin Nickel, Antique Nickel, Rustic Umber, Oil-Rubbed* and Matte Black finishes
- ▶ Sash lift handles in Clay, White, Beige, Brass, Antique Brass, Satin Nickel, Antique Nickel, Rustic Umber, Oil-Rubbed* and Matte Black finishes
- ▶ Universal design crank handle hardware kit in White
- ▶ White jamb liners
- ▶ Full or half screens with aluminum frames and options for BetterVue® or UltraVue® fiberglass screen mesh or aluminum screen mesh; frames will match the exterior color of the unit
- ▶ StormGuard combination storm/screen units (pg. 191)
- ▶ Extension jambs (up to 12" applied, over 12" shipped loose for field application)
- ▶ Sash limiters for safety
- ▶ Galvanized steel installation clips
- ▶ Insulated platforms, support brackets, and oak-veneered head and seat boards for bay units
- ▶ Available as replacement sash kits (pg. 76)

Magnum Double Hungs



Magnum double hungs have a thicker sash than traditional double hung windows. Their distinctive, classically inspired design works efficiently thanks to their high-quality operational mechanisms. These state-of-the-art windows are ideal for enhancing exceptionally large spaces.

Magnum Double Hung Standard Features

- ▶ 1-3/4" thick sash
- ▶ Overall jamb width is 5-9/16" (*basic box width is 5-9/16"*)
- ▶ Frame thickness is 1-1/16" at side jambs and head
- ▶ Sill thickness is 1-5/16"; slope is 14°
- ▶ Stiles and top rail width is 2-9/16", bottom rail width is 3-5/8"
- ▶ Constructed of pine, with pine interior stops and wood mull casings on muller units with jambs wider than 5-9/16"
- ▶ Energy efficient, insulating LoE²-270 glass
- ▶ Glazed to the interior with beveled wood glazing beads
- ▶ 1-15/16" exterior brickmould applied
- ▶ All exterior wood parts are preservative-treated
- ▶ Exterior frame and sash are latex primed
- ▶ Rigid PVC head parting stop with flexible fins and waterseal at the sill
- ▶ Fully weatherstripped for a tight seal
- ▶ Two clay-colored heavy duty sash locks
- ▶ Spring-loaded block-and-tackle mechanical balances to carry the sash weight (*four per sash*)
- ▶ Beige PVC jambliners with compression foam backing

NOTE: All measurements are nominal.



1-15/16" brickmould applied as standard

Hardware

Two Clay-colored cam locks are factory-applied to Magnum double hung units as standard. Other finishes available are White, Beige, Brass, Antique Brass, Satin Nickel, Antique Nickel, Rustic Umber, Oil-Rubbed,* and Matte Black. Sash lift handles are optional.

*The Oil-Rubbed finish is a living finish, which means that it will change appearance over time with use.



Sash lock in Clay (*standard*)



Square style sash lift handle in Satin Nickel



Traditional style sash lift handle in Matte Black



Magnum Double Hung Optional Features

Glass (pgs. 184-185):

- ▶ LoE-180
- ▶ LoE²-240
- ▶ LoE³-366
- ▶ ThermaPlus™ LoE
- ▶ Patterned, bronze- or gray-lite
- ▶ Tempered or laminated
- ▶ Other options standard to the industry

Divided Lites (pgs. 186-187):

- ▶ Performance divided lites with 5/8", 7/8", 1-1/8", 1-3/4", 2-1/4", or 4-1/2" bars
- ▶ True divided lites with 5/8" LoE² insulating glass and 1-1/8" bars
- ▶ Grilles-in-the-air-space
- ▶ Interior removable wood grilles with 7/8" or 1-1/8" bars and full surrounds

Exterior Finishes (pg. 189):

- ▶ K-Kron II exterior paint finish

Other Options: (custom options are also available)

- ▶ Other wood species and FSC-certified wood (pg. 188)
- ▶ Interior prefinishing (pg. 188)
- ▶ Interior casing (pg. 190)

NOTE: All measurements are nominal.

*The Oil-Rubbed finish is a living finish, which means that it will change appearance over time with use.

- ▶ Prep for stool
- ▶ 3-1/2" flat or profiled brickmould, backband on 3-1/2" brickmould and other custom millwork (pg. 190)
- ▶ Projected sill nosing, extended sill horns or no nosing
- ▶ Ovolo and square profile glazing beads and interior divided lite bars (pg. 192)
- ▶ White jamb liners
- ▶ Sash locks in White, Beige, Brass, Antique Brass, Satin Nickel, Antique Nickel, Rustic Umber, Oil-Rubbed* and Matte Black finishes
- ▶ Sash lift handles in Clay, White, Beige, Brass, Antique Brass, Satin Nickel, Antique Nickel, Rustic Umber, Oil-Rubbed* and Matte Black finishes
- ▶ Full or half screens with aluminum frames and options for BetterVue® or UltraVue® fiberglass screen mesh or aluminum screen mesh; frames will match the exterior color of the unit
- ▶ Extension jambs (up to 12" applied; over 12" shipped loose for field application)
- ▶ Galvanized steel installation clips
- ▶ Narrow mull covers
- ▶ Available as replacement sash kits (pg. 76)

Old World Classic Double Hungs



Old World Classic double hungs replicate the charm of historical double hung windows for historically-accurate renovations and projects. Their visible brass pulley system with solid brass chains and alloyed weights create seamless operation. What's more, every Old World Classic window is engineered especially for each unique project, offering an unprecedented level of customization.

Old World Classic Double Hung Standard Features

- ▶ 1-3/4" thick sash
- ▶ Basic frame jamb width is 6-9/16"
- ▶ Constructed of pine with pine interior head parting stops and side stops
- ▶ Energy efficient, insulating LoE²-270 glass
- ▶ 1-15/16" exterior brickmould applied
- ▶ Exterior frame and sash are latex primed
- ▶ All exterior wood parts are preservative-treated
- ▶ Heavy duty sash lock with Brass finish
- ▶ Brass chains and pulleys
- ▶ Fully weatherstripped for a tight seal
- ▶ A proportionate balance between sash and alloyed weights creates a one-to-one ratio

NOTE: All measurements are nominal.



Brass chains and pulleys



Brass sash locks



Optional ogee lugs

Hardware

Heavy duty cam locks in a Brass finish are factory-applied to Old World Classic double hung units as standard. Sash lift handles are optional. All double hung hardware is available in Clay, White, Beige, Brass, Antique Brass, Satin Nickel, Antique Nickel, Rustic Umber, Oil-Rubbed,* and Matte Black.

*The Oil-Rubbed finish is a living finish, which means that it will change appearance over time with use.



Sash lock in Brass (standard)



Square style sash lift handle in Satin Nickel



Traditional style sash lift handle in Matte Black



Old World Classic Double Hung Optional Features

Glass (pgs. 184-185):

- ▶ LoE-180
- ▶ LoE²-240
- ▶ LoE³-366
- ▶ ThermaPlus™ LoE
- ▶ Patterned, bronze- or gray-lite
- ▶ Tempered or laminated
- ▶ Other options standard to the industry

Divided Lites (pgs. 186-187):

- ▶ Performance divided lites with 5/8", 7/8", 1-1/8", 1-3/4", 2-1/4", or 4-1/2" bars
- ▶ True divided lites with 5/8" LoE² insulating glass and 1-1/8" bars
- ▶ Grilles-in-the-air-space
- ▶ Interior removable wood grilles with 7/8" or 1-1/8" bars and full surrounds

Exterior Finishes (pg. 189):

- ▶ K-Kron II exterior paint finish

Other Options: (custom options are also available)

- ▶ Available as single, double or triple hung
- ▶ Other wood species and FSC-certified wood (pg. 188)

NOTE: All measurements are nominal.

*The Oil-Rubbed finish is a living finish, which means that it will change appearance over time with use.

- ▶ Interior prefinishing (pg. 188)
- ▶ Interior casing (pg. 190)
- ▶ 3-1/2" flat or profiled brickmould, backband on 3-1/2" brickmould and other custom millwork (pg. 190)
- ▶ Projected sill nosing, extended sill horns or no nosing
- ▶ Ovolo and square profile glazing beads and interior divided lite bars (pg. 192)
- ▶ Prep for stool
- ▶ Ogee lugs integrated into the top sash stiles
- ▶ Cam locks in White, Clay, Beige, Antique Brass, Satin Nickel, Antique Nickel, Rustic Umber, Oil-Rubbed* and Matte Black finishes
- ▶ Sash lift handles (finish will match other hardware)
- ▶ Oil-Rubbed,* Polished Nickel and Satin Nickel chains and pulleys
- ▶ Half or full screens with BetterVue® or UltraVue® fiberglass screen mesh, or aluminum mesh, and aluminum frames that match the exterior color of the unit
- ▶ Galvanized steel installation clips
- ▶ High performance modifications

Replacement Double Hung Sash Kits



Replacement Sash Kits

Updating your project with new, energy-efficient windows that have the convenience of tilt-in sash is easy with Kolbe's double hung replacement sash kits. There are no worries about tearing into walls or ruining specialty mouldings that provide character and charm because sash are made to fit into your existing window frames. Plus, installation is a snap and is done from the interior, so installation can be done from any height. Kits are available with Traditional or Magnum double hung sash and include spring-loaded, counter balanced jambliners. Both sash open for ventilation and tilt in or may be removed for easy cleaning. Sash are also available as cottage-style and reverse cottage-style double hungs. Many options such as exterior finishes, glazing options and divided lite options help to preserve the original design of your home or add a new twist. Standard and optional features for replacement sash are the same as fully framed Traditional (see pg. 70) or Magnum double hung sash (see pg. 72).

NOTE: The same standard and optional features of Heritage Series Traditional double hung and Heritage Series Magnum double hung windows apply to replacement sash kits.

Double Hung Replacement Sash Kits Include:

- (1) Top sash
- (2) PVC jambliners with compression-foam backing
- (3) Wood head parting stop
- (4) Vinyl head parting stop
- (5) Tacks
- (6) Jambliner clips
- (7) Vinyl sash stops
- (8) Foam pads
- (9) Screws
- (10) Bottom sash
- (11) Energy efficient, insulating LoE²-270 glass
- (12) Heavy duty sash lock (*Magnum sash have two*)
- (13) Spring-loaded block-and-tackle mechanical balances (*not pictured*)

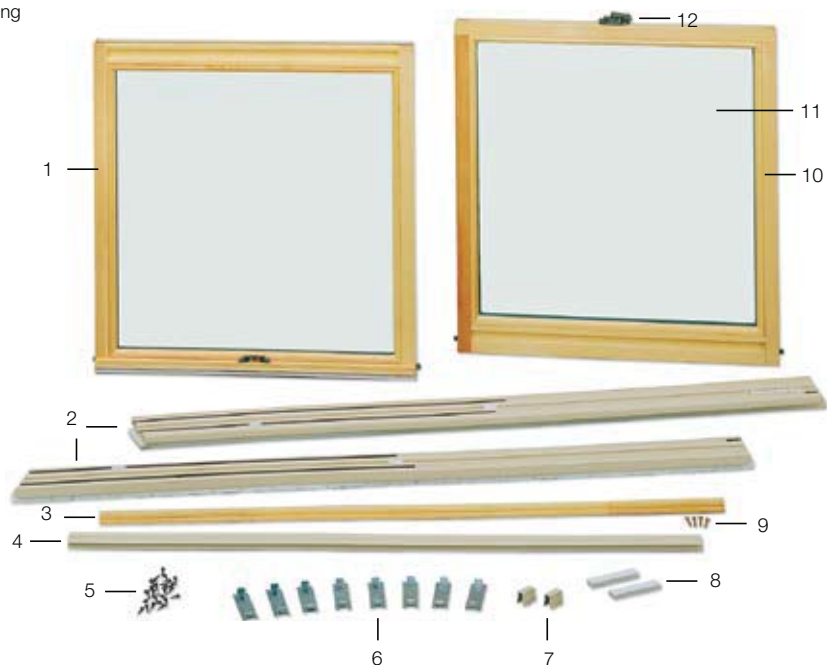



Double Hungs | Elevation Charts

Sterling & Traditional Double Hungs | Single Units

U.D.	1'-11 7/8"	2'-3 7/8"	2'-7 7/8"	2'-9 7/8"	2'-11 7/8"	3'-1 7/8"	3'-3 7/8"	3'-7 7/8"	3'-11 7/8"
R.O.	1'-10"	2'-2"	2'-6"	2'-8"	2'-10"	3'-0"	3'-2"	3'-6"	3'-10"
S.O.	1'-8"	2'-0"	2'-4"	2'-6"	2'-8"	2'-10"	3'-0"	3'-4"	3'-8"
G.S.	16"	20"	24"	26"	28"	30"	32"	36"	40"
3'-2 1/8"									
3'-5"									
3'-10"									
4'-2 1/8"									
4'-5"									
4'-10 1/8"									
4'-11"									
5'-2 1/8"									
5'-5"									
5'-10 1/8"									
5'-11"									
6'-2 1/8"									
6'-5"									
6'-10 1/8"									
6'-11"									
6'-10 1/8"									

NOTE: All measurements are nominal. Elevation charts are not to scale.

Single units shown are also available as single hung units and replacement sash kits with Traditional sash only.

Divided lites are optional.

Some installation procedures will require a larger rough opening than noted (i.e. installations utilizing our installation clips), therefore, you may need to increase the rough opening size accordingly. Rough opening gaps may be increased up to a maximum of 1/2" on all sides and still be within good practice guidelines. For rough opening recommendations, see pg. 196.

The side jambs of double hung units extend above the head jamb; additional space for the rough opening height may be necessary.

* Units meet most national emergency escape and rescue requirements.

** Only Traditional sash units meet most national emergency escape and rescue requirements.

PRODUCT CODES:

To order, add "W" before the product number and "-1," "-2," or "-3" after to denote a single, twin or triple unit, respectively (Ex: WDH4036-1). Specify Traditional or Sterling sash.

U.D. = Unit Dimension

R.O. = Rough Opening

S.O. = Sash Opening

G.S. = Glass Size

Sterling & Traditional Double Hungs | Cottage-Style

U.D.	1'-11 7/8"	2'-3 7/8"	2'-7 7/8"	2'-9 7/8"	2'-11 7/8"	3'-1 7/8"	3'-3 7/8"	3'-7 7/8"	3'-11 7/8"
R.O.	1'-10"	2'-2"	2'-6"	2'-8"	2'-10"	3'-0"	3'-2"	3'-6"	3'-10"
S.O.	1'-8"	2'-0"	2'-4"	2'-6"	2'-8"	2'-10"	3'-0"	3'-4"	3'-8"
G.S.	16"	20"	24"	26"	28"	30"	32"	36"	40"

(DH1614-2)



Width Dimensions for Twin-Mulled Units

Glass (per-sash)	16"	20"	24"	26"	28"	30"	32"	36"	40"
R.O.	3'-7 1/2"	4'-3 1/2"	4'-11 1/2"	5'-3 1/2"	5'-7 1/2"	5'-11 1/2"	6'-3 1/2"	6'-11 1/2"	7'-7 1/2"
U.D.	3'-9 3/8"	4'-5 3/8"	5'-1 3/8"	5'-5 3/8"	5'-9 3/8"	6'-1 3/8"	6'-5 3/8"	7'-1 3/8"	7'-9 3/8"

(DH1614-3)

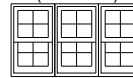

Width Dimensions for Triple-Mulled Units

Glass (per-sash)	16"	20"	24"	26"	28"	30"	32"	36"	40"
R.O.	5'-5"	6'-5"	7'-5"	7'-11"	8'-5"	8'-11"	9'-5"	10'-5"	11'-5"
U.D.	5'-6 7/8"	6'-6 7/8"	7'-6 7/8"	8'-0 7/8"	8'-6 7/8"	9'-0 7/8"	9'-6 7/8"	10'-6 7/8"	11'-6 7/8"

NOTE: All measurements are nominal. Elevation charts are not to scale.

Divided lites are optional.

Some installation procedures will require a larger rough opening than noted (i.e. installations utilizing our installation clips), therefore, you may need to increase the rough opening size accordingly. Rough opening gaps may be increased up to a maximum of 1/2" on all sides and still be within good practice guidelines.

The side jambs of double hung units extend above the head jamb; additional space for the rough opening height may be necessary. For rough opening recommendations, see pg. 196.

PRODUCT CODES:

To order, add "W" before the product number and "-1," "-2," or "-3" after to denote a single, twin or triple unit, respectively (Ex: WDH1624/36-1). Specify Traditional or Sterling sash.

U.D. = Unit Dimension • R.O. = Rough Opening

S.O. = Sash Opening • G.S. = Glass Size

Dimension Calculations

Elevation charts provide wood unit dimensions for units with the standard 1 15/16" brickmould. Below are the calculations to determine the frame size of units with brickmould.

	Width	Height
1-15/16" brickmould; U.D. to F.S.	-2 3/8"	-1 11/16"
3-1/2" flat or profiled casing; U.D. to F.S.	-5 5/12"	-3 1/4"
3-1/2" casing and backband; U.D. to F.S.	-7"	-4 3/16"

F.S. to S.O.	-1 1/2"	-2 7/16"
S.O. to G.S.	-4"	-6 2"
G.S. to D.L.O.	-1"	-1"

Note: Clear opening dimensions can be found on pgs. 198-201.
Cottage-style dimension calculations are different; please contact your dealer.

F.S. = Frame Size • G.S. = Glass Size • O.S.M. = Outside Measurement
D.L.O. = Daylight Opening • U.D. = Unit Dimension

Double Hungs | Elevation Charts

Double Hungs | Rectangular Transoms

U.D.	1'-11 7/8"	2'-3 7/8"	2'-7 7/8"	2'-11 7/8"	3'-3 7/8"	3'-7 7/8"	3'-11 7/8"
R.O.	1'-10"	2'-2"	2'-6"	2'-10"	3'-2"	3'-6"	3'-10"
S.O.	1'-8"	2'-0"	2'-4"	2'-8"	3'-0"	3'-4"	3'-8"
G.S.	16"	20"	24"	28"	32"	36"	40"
1'-1 1/8"							
1'-5 1/8"							
1'-7 1/8"							
1'-9 1/8"							
2'-1 1/8"							
2'-7 1/8"							

NOTE: All measurements are nominal. These dimensions apply only for transoms with flat sills. Contact your supplier for dimensions of units with beveled sills. Elevation charts are not to scale.

Transom units are only available with a 1-3/4" sash. The units shown are stand-alone units. Adjustments may be required when stacking over other units; adjustments will be made in the factory.

Divided lites are optional.

Some installation procedures will require a larger rough opening than noted (i.e. installations utilizing our installation clips), therefore, you may need to increase the rough opening size accordingly. Rough opening gaps may be increased up to a maximum of 1/2" on all sides and still be within good practice guidelines. For rough opening recommendations, see pg. 196.

The side jambs of double hung units extend above the head jamb; additional space for the rough opening height may be necessary.

PRODUCT CODES:

To order transoms, add "W" before the product number (Ex: WDHT4024).

U.D. = Unit Dimension • R.O. = Rough Opening • S.O. = Sash Opening • G.S. = Glass Size

Double Hungs | Studio Units

	U.D.	4'-3 7/8"	4'-7 7/8"	5'-3 7/8"	5'-11 7/8"	6'-7 7/8"	7'-3 7/8"	8'-7 7/8"
	R.O.	4'-2"	4'-6"	5'-2"	5'-10"	6'-6"	7'-2"	8'-6"
	S.O.	4'-0"	4'-4"	5'-0"	5'-8"	6'-4"	7'-0"	8'-4"
	G.S.	44 1/2"	48 1/2"	56 1/2"	64 1/2"	72 1/2"	80 1/2"	96 1/2"
4'-2 1/8"	4'-2 1/8"							
	4'-4 1/8"	DHS40310	DHS44310	DHS50310	DHS58310	DHS64310	DHS70310	DHS84310
4'-6 1/8"	4'-5 1/8"							
	4'-7 1/8"	DHS4042	DHS4442	DHS5042	DHS5842	DHS6442	DHS7042	DHS8442
4'-10 1/8"	4'-9 1/8"							
	4'-11 1/8"	DHS4046	DHS4446	DHS5046	DHS5846	DHS6446	DHS7046	DHS8446
5'-2 1/8"	5'-1 1/8"							
	5'-3 1/8"	DHS40410	DHS44410	DHS50410	DHS58410	DHS64410	DHS70410	DHS84410
5'-6 1/8"	5'-5 1/8"							
	5'-6 1/4"	DHS4052	DHS4452	DHS5052	DHS5852	DHS6452	DHS7052	DHS8452
5'-10 1/8"	5'-9 1/8"							
	5'-10 1/4"	DHS4056	DHS4456	DHS5056	DHS5856	DHS6456	DHS7056	DHS8456
6'-2 1/8"	6'-1 1/8"							
	6'-2 1/4"	DHS40510	DHS44510	DHS50510	DHS58510	DHS64510	DHS70510	DHS84510
6'-6 1/8"	6'-5 1/8"							
	6'-6 1/4"	DHS4062	DHS4462	DHS5062	DHS5862	DHS6462	DHS7062	DHS8462
6'-10 1/8"	6'-9 1/8"							
	6'-10 1/4"	DHS4066	DHS4466	DHS5066	DHS5866	DHS6466	DHS7066	DHS8466

NOTE: All measurements are nominal. Elevation charts are not to scale.

Studio units are only available with a 1-3/4" sash.

Divided lites are optional.

Some installation procedures will require a larger rough opening than noted (i.e. installations utilizing our installation clips), therefore, you may need to increase the rough opening size accordingly. Rough opening gaps may be increased up to a maximum of 1/2" on all sides and still be within good practice guidelines. For rough opening recommendations, see pg. 196.

The side jambs of double hung units extend above the head jamb; additional space for the rough opening height may be necessary.

* To match cottage-style double hungs with divided lites, 5'-6" high (S.O.) units must be ordered 5 lites high.

PRODUCT CODES:

To order, add "W" before the product number (Ex: WDHS8466).

U.D. = Unit Dimension • R.O. = Rough Opening • S.O. = Sash Opening • G.S. = Glass Size

Double Hungs | Elevation Charts

Sterling & Traditional Double Hungs | Picture Units

16" flankers

U.D.	8'-2 7/8"	8'-10 7/8"	9'-6 7/8"	10'-2 7/8"
R.O.	8'-1"	8'-9"	9'-5"	10'-1"
S.O.	1'-8" 4'-4" 1'-8"	1'-8" 5'-0" 1'-8"	1'-8" 5'-8" 1'-8"	1'-8" 6'-4" 1'-8"
G.S.*	16" 48 1/2" 16"	16" 56 1/2" 16"	16" 64 1/2" 16"	16" 72 1/2" 16"
4'-6 1/8"				
4'-10 1/8"				
5'-6 1/8"				

Sterling & Traditional Double Hungs | Picture Units

20" flankers

U.D.	8'-10 7/8"	9'-6 7/8"	10'-2 7/8"	10'-10 7/8"
R.O.	8'-9"	9'-5"	10'-1"	10'-9"
S.O.	2'-0" 4'-4" 2'-0"	2'-0" 5'-0" 2'-0"	2'-0" 5'-8" 2'-0"	2'-0" 6'-4" 2'-0"
G.S.*	20" 48 1/2" 20"	20" 56 1/2" 20"	20" 64 1/2" 20"	20" 72 1/2" 20"
4'-6 1/8"				
4'-10 1/8"				
5'-6 1/8"				

NOTE: All measurements are nominal. Elevation charts are not to scale.

Center picture units are only available with a 1-3/4" sash. Flanker sash must be specified as either Traditional or Sterling sash when ordering.

Divided lites are optional.

Some installation procedures will require a larger rough opening than noted (i.e. installations utilizing our installation clips), therefore, you may need to increase the rough opening size accordingly. Rough opening gaps may be increased up to a maximum of 1/2" on all sides and still be within good practice guidelines. For rough opening recommendations, see pg. 196.

The side jambs of double hung units extend above the head jamb; additional space for the rough opening height may be necessary.

* The first number of the glass size height is the height (per sash) for each flanker sash. The second number is the glass height for the center picture unit.

PRODUCT CODES:

To order, add "W" before the product number (Ex: WDH20286452).

U.D. = Unit Dimension • R.O. = Rough Opening • S.O. = Sash Opening • G.S. = Glass Size

Sterling & Traditional Double Hungs | Picture Units

24" flankers

U.D.	9'-6 7/8"	10'-2 7/8"	10'-10 7/8"	11'-6 7/8"
R.O.	9'-5"	10'-1"	10'-9"	11'-5"
S.O.	2'-4" 4'-4" 2'-4"	2'-4" 5'-0" 2'-4"	2'-4" 5'-8" 2'-4"	2'-4" 6'-4" 2'-4"
G.S.*	24" 48 1/2" 24"	24" 56 1/2" 24"	24" 64 1/2" 24"	24" 72 1/2" 24"
4'-6 1/8"				
4'-10 1/8"				
5'-6 1/8"				

NOTE: All measurements are nominal. Elevation charts are not to scale.

Center picture units are only available with a 1-3/4" sash. Wood flanker sash must be specified as either Traditional or Sterling sash when ordering.

Divided lites are optional.

Some installation procedures will require a larger rough opening than noted (i.e. installations utilizing our installation clips), therefore, you may need to increase the rough opening size accordingly. Rough opening gaps may be increased up to a maximum of 1/2" on all sides and still be within good practice guidelines. For rough opening recommendations, see pg. 196.

The side jambs of double hung units extend above the head jamb; additional space for the rough opening height may be necessary.

* The first number of the glass size height is the height (per sash) for each flanker sash. The second number is the glass height for the center picture unit.

PRODUCT CODES:

To order, add "W" before the product number (Ex: WDH24286452).

U.D. = Unit Dimension • R.O. = Rough Opening • S.O. = Sash Opening • G.S. = Glass Size

Double Hungs | Elevation Charts

Sterling & Traditional Double Hungs | 30° Bay Windows

16" flankers

20" flankers

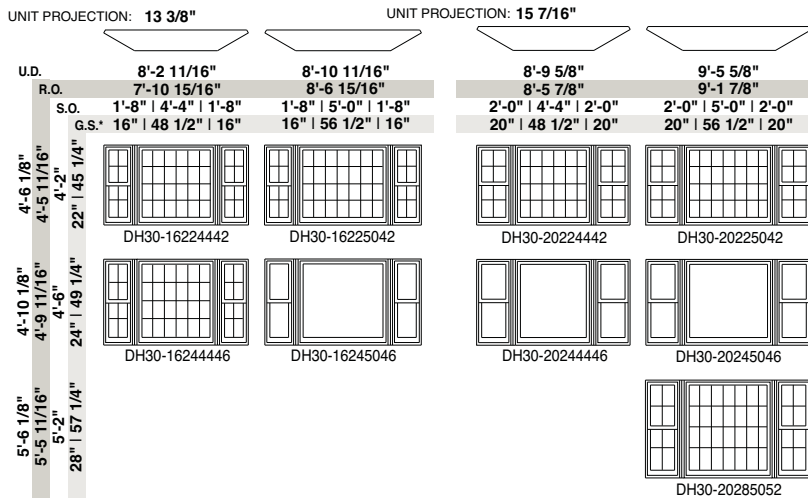

Sterling & Traditional Double Hungs | 45° Bay Windows

16" flankers

20" flankers

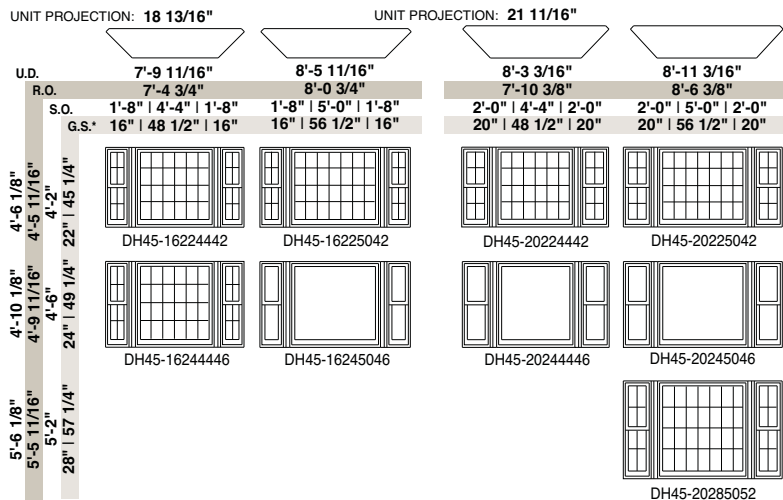

NOTE: All measurements are nominal. Elevation charts are not to scale.

Center picture units are only available with a 1-3/4" sash. Flanker sash must be specified as either Traditional or Sterling sash when ordering.

Divided lites are optional.

If the cable support system and/or insulated platforms & support brackets are not being used, other means of proper support must be used. Add 1-13/16" to the R.O. height if an insulated platform is being used. R.O.'s for bay units without head and seat boards, typically used for walk-out applications, are different.

Some installation procedures will require a larger rough opening than noted (i.e. installations utilizing our installation clips), therefore, you may need to increase the rough opening size accordingly. Rough opening gaps may be increased up to a maximum of 1/2" on all sides and still be within good practice guidelines. For rough opening recommendations, see pg. 196.

The side jambs of double hung units extend above the head jamb; additional space for the rough opening height may be necessary.

* The first number of the glass size height is the height (per sash) for each flanker sash. The second number is the glass height for the center picture unit.

PRODUCT CODES:

To order, add "W" before the product number

(Ex: WDH45-20285052).

U.D. = Unit Dimension • R.O. = Rough Opening • S.O. = Sash Opening • G.S. = Glass Size

Sterling & Traditional Segment Head Double Hungs

U.D.	1'-11 7/8"	2'-3 7/8"	2'-7 7/8"	2'-9 7/8"	2'-11 7/8"	3'-1 7/8"	3'-3 7/8"	3'-7 7/8"	3'-11 7/8"
R.O.	1'-10"	2'-2"	2'-6"	2'-8"	2'-10"	3'-0"	3'-2"	3'-6"	3'-10"
S.O.	1'-8"	2'-0"	2'-4"	2'-6"	2'-8"	2'-10"	3'-0"	3'-4"	3'-8"
G.S.*	16"	20"	24"	26"	28"	30"	32"	36"	40"
3'-2 1/8"	3'-1 1/4"	3'-1 1/4"	3'-1 1/4"	3'-1 1/4"	3'-1 1/4"	3'-1 1/4"	3'-1 1/4"	3'-1 1/4"	3'-1 1/4"
3'-6 1/8"	3'-5 1/4"	3'-5 1/4"	3'-5 1/4"	3'-5 1/4"	3'-5 1/4"	3'-5 1/4"	3'-5 1/4"	3'-5 1/4"	3'-5 1/4"
4'-2 1/8"	4'-1 1/4"	4'-1 1/4"	4'-1 1/4"	4'-1 1/4"	4'-1 1/4"	4'-1 1/4"	4'-1 1/4"	4'-1 1/4"	4'-1 1/4"
4'-6 1/8"	4'-5 1/4"	4'-5 1/4"	4'-5 1/4"	4'-5 1/4"	4'-5 1/4"	4'-5 1/4"	4'-5 1/4"	4'-5 1/4"	4'-5 1/4"
4'-10 1/8"	4'-9 1/4"	4'-9 1/4"	4'-9 1/4"	4'-9 1/4"	4'-9 1/4"	4'-9 1/4"	4'-9 1/4"	4'-9 1/4"	4'-9 1/4"
5'-2 1/8"	5'-1 1/4"	5'-1 1/4"	5'-1 1/4"	5'-1 1/4"	5'-1 1/4"	5'-1 1/4"	5'-1 1/4"	5'-1 1/4"	5'-1 1/4"
5'-6 1/8"	5'-5 1/4"	5'-5 1/4"	5'-5 1/4"	5'-5 1/4"	5'-5 1/4"	5'-5 1/4"	5'-5 1/4"	5'-5 1/4"	5'-5 1/4"
5'-10 1/8"	5'-9 1/4"	5'-9 1/4"	5'-9 1/4"	5'-9 1/4"	5'-9 1/4"	5'-9 1/4"	5'-9 1/4"	5'-9 1/4"	5'-9 1/4"
6'-2 1/8"	6'-1 1/4"	6'-1 1/4"	6'-1 1/4"	6'-1 1/4"	6'-1 1/4"	6'-1 1/4"	6'-1 1/4"	6'-1 1/4"	6'-1 1/4"
6'-6 1/8"	6'-5 1/4"	6'-5 1/4"	6'-5 1/4"	6'-5 1/4"	6'-5 1/4"	6'-5 1/4"	6'-5 1/4"	6'-5 1/4"	6'-5 1/4"
6'-10 1/8"	6'-9 1/4"	6'-9 1/4"	6'-9 1/4"	6'-9 1/4"	6'-9 1/4"	6'-9 1/4"	6'-9 1/4"	6'-9 1/4"	6'-9 1/4"
	WDH1614-SEG	WDH2014-SEG	WDH2414-SEG	WDH2614-SEG	WDH2814-SEG	WDH3014-SEG	WDH3214-SEG	WDH3614-SEG	WDH4014-SEG
	WDH1616-SEG	WDH2016-SEG	WDH2416-SEG	WDH2616-SEG	WDH2816-SEG	WDH3016-SEG	WDH3216-SEG	WDH3616-SEG	WDH4016-SEG
	WDH1620-SEG	WDH2020-SEG	WDH2420-SEG	WDH2620-SEG	WDH2820-SEG	WDH3020-SEG	WDH3220-SEG	WDH3620-SEG	WDH4020-SEG
	WDH1622-SEG	WDH2022-SEG	WDH2422-SEG	WDH2622-SEG	WDH2822-SEG	WDH3022-SEG	WDH3222-SEG	WDH3622-SEG	WDH4022-SEG
	WDH1624-SEG	WDH2024-SEG	WDH2424-SEG	WDH2624-SEG	WDH2824-SEG	WDH3024-SEG	WDH3224-SEG	WDH3624-SEG	WDH4024-SEG
	WDH1626-SEG	WDH2026-SEG	WDH2426-SEG	WDH2626-SEG	WDH2826-SEG	WDH3026-SEG	WDH3226-SEG	WDH3626-SEG	WDH4026-SEG
	WDH1628-SEG	WDH2028-SEG	WDH2428-SEG	WDH2628-SEG	WDH2828-SEG	WDH3028-SEG	WDH3228-SEG	WDH3628-SEG	WDH4028-SEG
	WDH1630-SEG	WDH2030-SEG	WDH2430-SEG	WDH2630-SEG	WDH2830-SEG	WDH3030-SEG	WDH3230-SEG	WDH3630-SEG	WDH4030-SEG
	WDH1632-SEG	WDH2032-SEG	WDH2432-SEG	WDH2632-SEG	WDH2832-SEG	WDH3032-SEG	WDH3232-SEG	WDH3632-SEG	WDH4032-SEG
	WDH1634-SEG	WDH2034-SEG	WDH2434-SEG	WDH2634-SEG	WDH2834-SEG	WDH3034-SEG	WDH3234-SEG	WDH3634-SEG	WDH4034-SEG
	WDH1636-SEG	WDH2036-SEG	WDH2436-SEG	WDH2636-SEG	WDH2836-SEG	WDH3036-SEG	WDH3236-SEG	WDH3636-SEG	WDH4036-SEG

NOTE: All measurements are nominal. Elevation charts are not to scale.

The venting of the bottom sash of segment head units is limited due to the radius on the top sash.

Divided lites are optional.

Some installation procedures will require a larger rough opening than noted (i.e. installations utilizing our installation clips), therefore, you may need to increase the rough opening size accordingly. Rough opening gaps may be increased up to a maximum of 1/2" on all sides and still be within good practice guidelines. For rough opening recommendations, see pg. 196.

The side jambs of double hung units extend above the head jamb; additional space for the rough opening height may be necessary.

* Approximate glass sizes per sash are given; true glass sizes vary depending on the radius involved.

PRODUCT CODES:

To order, use the product code shown and specify Traditional or Sterling sash, wood profile.

U.D. = Unit Dimension • R.O. = Rough Opening • S.O. = Sash Opening • G.S. = Glass Size

Double Hungs | Elevation Charts

Sterling & Traditional Segment Head Double Hungs | Cottage-Style

	1'-11 7/8"	2'-3 7/8"	2'-7 7/8"	2'-9 7/8"	2'-11 7/8"	3'-1 7/8"	3'-3 7/8"	3'-7 7/8"	3'-11 7/8"
U.D.	1'-11 7/8"	2'-3 7/8"	2'-7 7/8"	2'-9 7/8"	2'-11 7/8"	3'-1 7/8"	3'-3 7/8"	3'-7 7/8"	3'-11 7/8"
R.O.	1'-10"	2'-2"	2'-6"	2'-8"	2'-10"	3'-0"	3'-2"	3'-6"	3'-10"
S.O.	1'-8"	2'-0"	2'-4"	2'-6"	2'-8"	2'-10"	3'-0"	3'-4"	3'-8"
G.S.*	16"	20"	24"	26"	28"	30"	32"	36"	40"

5'-10 1/8"									
5'-9"	4	4	5	5	5	5	6	6	7
5'-6"	WDH1624/36-SEG	WDH2024/36-SEG	WDH2424/36-SEG	WDH2624/36-SEG	WDH2824/36-SEG	WDH3024/36-SEG	WDH3224/36-SEG	WDH3624/36-SEG	WDH4024/36-SEG
36" 24"									

NOTE: All measurements are nominal. Elevation charts are not to scale.

The venting of the bottom sash of segment head units is limited due to the radius on the top sash.

Divided lites are optional.

Some installation procedures will require a larger rough opening than noted (i.e. installations utilizing our installation clips), therefore, you may need to increase the rough opening size accordingly. Rough opening gaps may be increased up to a maximum of 1/2" on all sides and still be within good practice guidelines. For rough opening recommendations, see pg. 196.

The side jambs of double hung units extend above the head jamb; additional space for the rough opening height may be necessary.

* Approximate glass sizes per sash are given; true glass sizes vary depending on the radius involved.

PRODUCT CODES:

To order, use the product code shown and specify Traditional or Sterling sash.

U.D. = Unit Dimension • R.O. = Rough Opening • S.O. = Sash Opening • G.S. = Glass Size

Segment Head Double Hungs | Studio Units

	4'-3 7/8"		4'-7 7/8"		5'-3 7/8"		5'-11 7/8"		6'-7 7/8"		7'-3 7/8"		8'-7 7/8"	
U.D.	4'-2"		4'-6"		5'-2"		5'-10"		6'-6"		7'-2"		8'-6"	
R.O.	4'-0"		4'-4"		5'-0"		5'-8"		6'-4"		7'-0"		8'-4"	
S.O.	44 1/2"		48 1/2"		56 1/2"		64 1/2"		72 1/2"		80 1/2"		96 1/2"	
G.S.*														
4'-2 1/8"														
4'-6 1/8"														
4'-10 1/8"														
5'-2 1/8"														
5'-6 1/8"														
5'-10 1/8"														
6'-2 1/8"														
6'-6 1/8"														
6'-10 1/8"														

NOTE: All measurements are nominal. Elevation charts are not to scale.

Studio units are only available with a 1-3/4" sash.

Divide lites are optional.

Some installation procedures will require a larger rough opening than noted (i.e. installations utilizing our installation clips), therefore, you may need to increase the rough opening size accordingly. Rough opening gaps may be increased up to a maximum of 1/2" on all sides and still be within good practice guidelines. For rough opening recommendations, see pg. 196.

The side jambs of double hung units extend above the head jamb; additional space for the rough opening height may be necessary.

* Approximate glass sizes per sash are given; true glass sizes vary depending on the radius involved.

PRODUCT CODES:

To order, use the product code shown and specify wood profile.

U.D. = Unit Dimension • R.O. = Rough Opening • S.O. = Sash Opening • G.S. = Glass Size

Double Hungs | Elevation Charts

Sterling & Traditional Half-Circle Top Single Hungs

U.D.	1'-11 7/8"	2'-3 7/8"	2'-7 7/8"	2'-9 7/8"	2'-11 7/8"	3'-1 7/8"	3'-3 7/8"	3'-7 7/8"	3'-11 7/8"
R.O.	1'-10"	2'-2"	2'-6"	2'-8"	2'-10"	3'-0"	3'-2"	3'-6"	3'-10"
S.O.	1'-8"	2'-0"	2'-4"	2'-6"	2'-8"	2'-10"	3'-0"	3'-4"	3'-8"
G.S.*	16"	20"	24"	26"	28"	30"	32"	36"	40"
3'-2 3/16"									
3'-3 3/16"									
3'-5 1/16"									
3'-6 3/16"									
3'-8 1/16"									
3'-9 1/16"									
3'-10 3/16"									
3'-11 7/8"									
4'-2 3/16"									
4'-3 3/16"									
4'-4 3/16"									

NOTE: All measurements are nominal. Elevation charts are not to scale.

The venting of the bottom sash of half-circle top units is limited due to the radius on the top sash.

Divided lites are optional.

Some installation procedures will require a larger rough opening than noted (i.e. installations utilizing our installation clips), therefore, you may need to increase the rough opening size accordingly. Rough opening gaps may be increased up to a maximum of 1/2" on all sides and still be within good practice guidelines. For rough opening recommendations, see pg. 196.

The side jambs of double hung units extend above the head jamb; additional space for the rough opening height may be necessary.

* Approximate glass sizes per sash are given; true glass sizes vary depending on the radius involved.

PRODUCT CODES:
To order, use the product code shown and specify Traditional or Sterling sash, wood profile.

U.D. = Unit Dimension









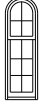

R.O. = Rough Opening

S.O. = Sash Opening

G.S. = Glass Size

Sterling & Traditional Half-Circle Top Single Hungs | Cottage-Style

U.D.	1'-11 7/8"	2'-3 7/8"	2'-7 7/8"	2'-9 7/8"	2'-11 7/8"	3'-1 7/8"	3'-3 7/8"	3'-7 7/8"	3'-11 7/8"
R.O.	1'-10"	2'-2"	2'-6"	2'-8"	2'-10"	3'-0"	3'-2"	3'-6"	3'-10"
S.O.	1'-8"	2'-0"	2'-4"	2'-6"	2'-8"	2'-10"	3'-0"	3'-4"	3'-8"
G.S.*	16"	20"	24"	26"	28"	30"	32"	36"	40"

<div style="display: inline-block; text-align: center;"> <div style="width: 100%; border-left: 1px solid black; border-right: 1px solid black; height: 100%;"></div> <div style="display: flex; justify-content: space-between; width: 100%; font-size: 8px;"> 5'-10 3/16" 5'-9 1/16" 5'-6" 36" 24" </div> </div>										
	WDH1624/36-HC	WDH2024/36-HC	WDH2424/36-HC	WDH2624/36-HC	WDH2824/36-HC	WDH3024/36-HC	WDH3224/36-HC	WDH3624/36-HC	WDH4024/36-HC	

NOTE: All measurements are nominal. Elevation charts are not to scale.

The venting of the bottom sash of half-circle top units is limited due to the radius on the top sash.

Divided lites are optional.

Some installation procedures will require a larger rough opening than noted (i.e. installations utilizing our installation clips), therefore, you may need to increase the rough opening size accordingly. Rough opening gaps may be increased up to a maximum of 1/2" on all sides and still be within good practice guidelines. For rough opening recommendations, see pg. 196.

The side jambs of double hung units extend above the head jamb; additional space for the rough opening height may be necessary.

* Approximate glass sizes per sash are given; true glass sizes vary depending on the radius involved.

PRODUCT CODES:

To order, use the product code shown and specify Traditional or Sterling sash, wood profile.

U.D. = Unit Dimension • R.O. = Rough Opening • S.O. = Sash Opening • G.S. = Glass Size

Double Hungs | Elevation Charts

Magnum Double Hungs

WOOD U.D.	3'-3 7/8"	3'-7 7/8"	3'-11 7/8"	4'-3 7/8"	4'-7 7/8"	4'-11 7/8"
R.O.	3'-2 5/8"	3'-6 5/8"	3'-10 5/8"	4'-2 5/8"	4'-6 5/8"	4'-10 5/8"
S.O.	3'-0"	3'-4"	3'-8"	4'-0"	4'-4"	4'-8"
G.S.	29 9/16"	33 9/16"	37 9/16"	41 9/16"	45 9/16"	49 9/16"
6'-6 5/8"						
6'-5 11/16"						
6'-2"						
33 9/16"						
6'-10 5/8"						
6'-9 11/16"						
6'-6"						
35 9/16"						
7'-6 5/8"						
7'-5 11/16"						
7'-2"						
39 9/16"						
8'-2 5/8"						
8'-1 11/16"						
7'-10"						
43 9/16"						
8'-10 5/8"						
8'-9 11/16"						
8'-6"						
47 9/16"						
9'-2 5/8"						
9'-1 11/16"						
8'-10"						
49 9/16"						

Dimension Calculations

Elevation charts provide wood unit dimensions for units with the standard 1 15/16" brickmould. Below are the calculations to determine the frame size of units with brickmould.

	Width	Height
1-15/16" brickmould; U.D. to F.S.	-1 3/4"	-1 7/16"
3-1/2" flat or profiled casing; U.D. to F.S.	-4 7/8"	-3"
3-1/2" casing and backband; U.D. to F.S.	-6 3/8"	-3 15/16"
F.S. to S.O.	-2 1/8"	-3 3/16"
S.O. to G.S.	-6 7/16"	-6 7/8" ÷ 2"
G.S. to D.L.O.	-1"	-1"

F.S. = Frame Size • G.S. = Glass Size • O.S.M. = Outside Measurement
D.L.O. = Daylight Opening • U.D. = Unit Dimension

NOTE: All measurements are nominal. Elevation charts are not to scale.

Single units shown are also available as single hung units and replacement sash kits.

Divided lites are optional.

Some installation procedures will require a larger rough opening than noted (i.e. installations utilizing our installation clips), therefore, you may need to increase the rough opening size accordingly. Rough opening gaps may be increased up to a maximum of 1/2" on all sides and still be within good practice guidelines. For rough opening recommendations, see pg. 196.

The side jambs of double hung units extend above the head jamb; additional space for the rough opening height may be necessary.

PRODUCT CODES:

To order, add "W" before the product number and "-1," "-2," or "-3" after to denote a single, twin or triple unit, respectively (Ex: WMDH3062-1).

U.D. = Unit Dimension • R.O. = Rough Opening • S.O. = Sash Opening • G.S. = Glass Size (Glass sizes are given per sash.)

Double Hungs Cross Section Drawings

Sterling Double Hung

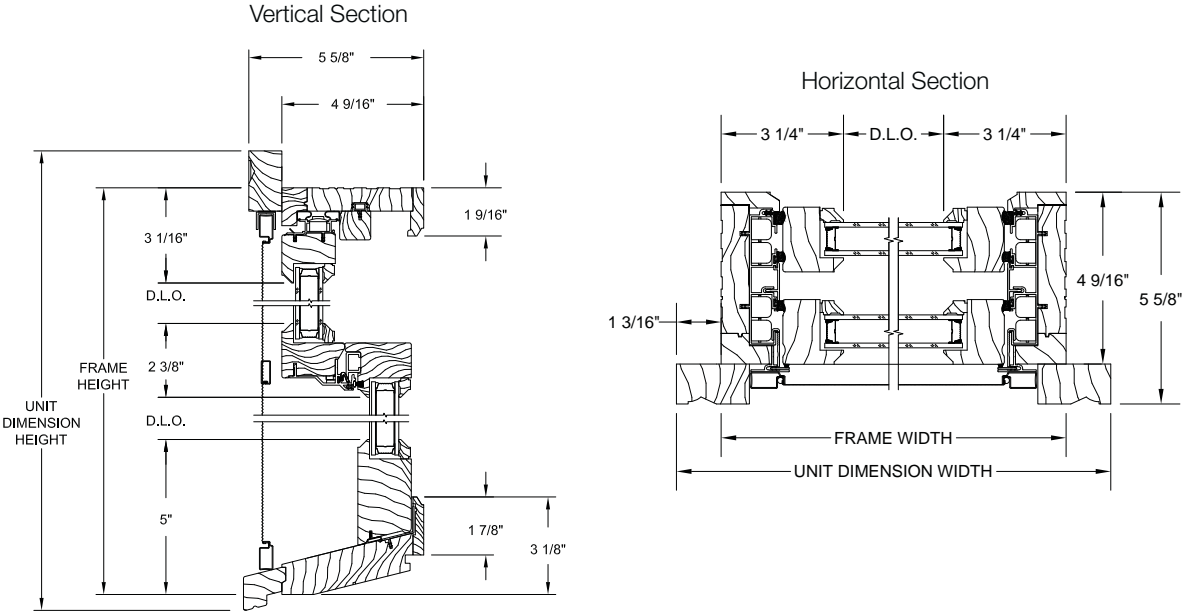

Traditional Double Hung

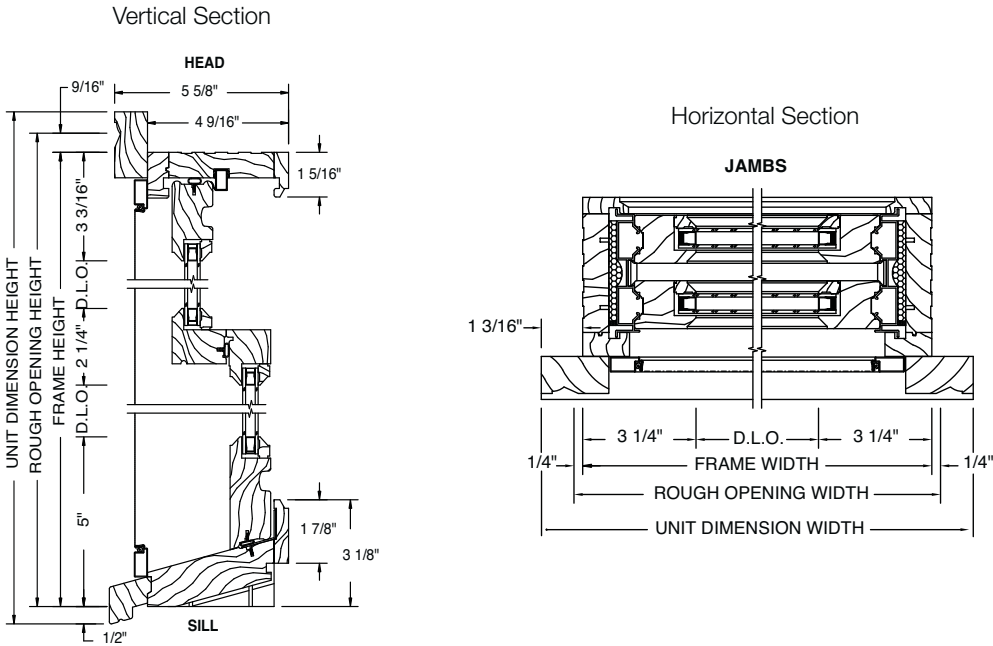

NOTE: Drawings are not to scale. Additional and the most current drawings are available in the Architect Library at www.kolbe-kolbe.com.

Double Hungs Cross Section Drawings

Sterling Double Hung Studio Unit

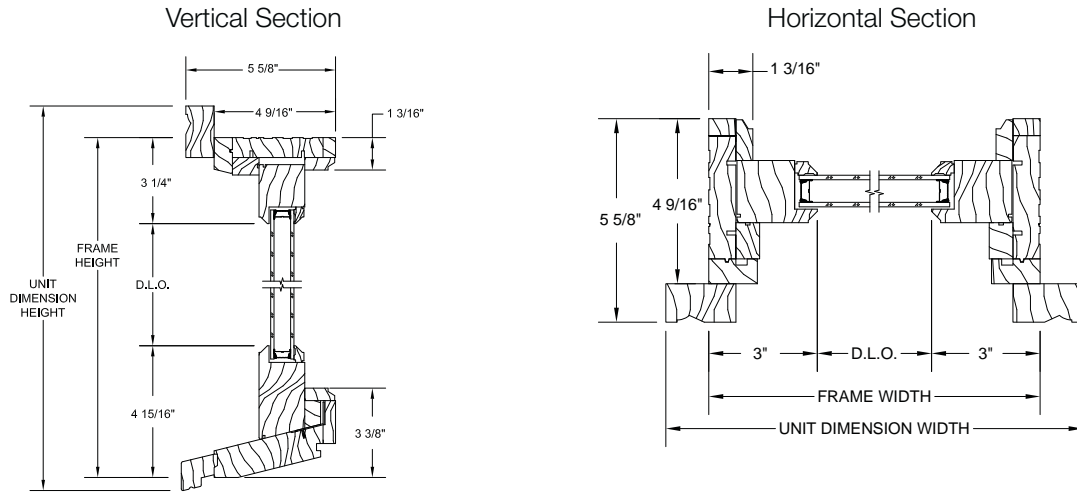

Traditional Double Hung Studio Unit

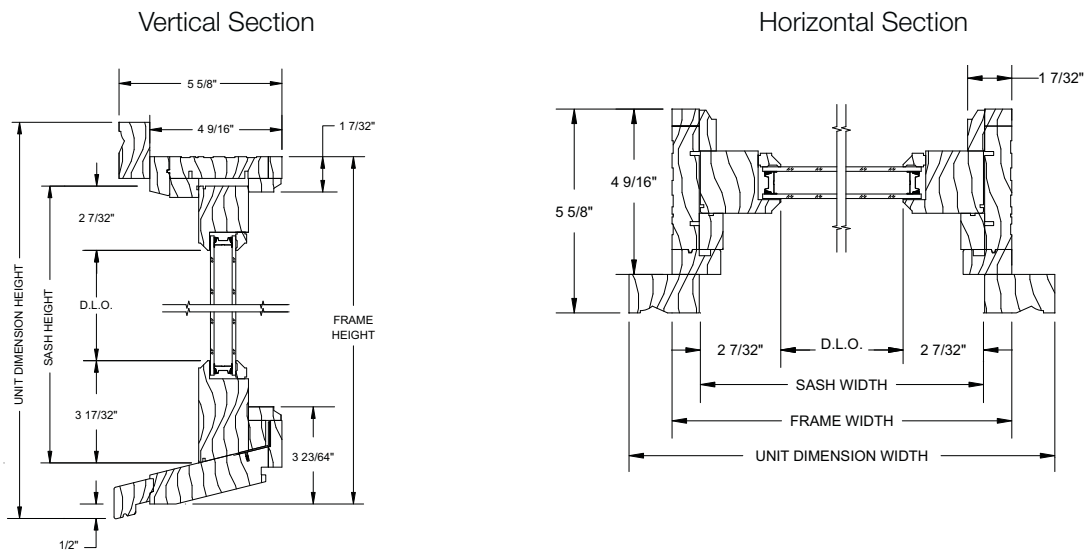

NOTE: Drawings are not to scale. Additional and the most current drawings are available in the Architect Library at www.kolbe-kolbe.com.

Rectangular Transom
Stacked Over
Traditional Double
Hung

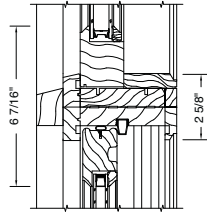

Double Hung
Transom with
Optional Beveled Sill

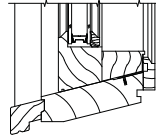

Standard Narrow
Mullion

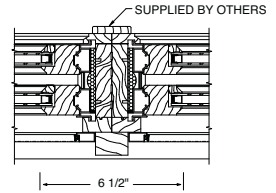

Traditional Double Hung 30° & 45° Bay Window

Vertical Section

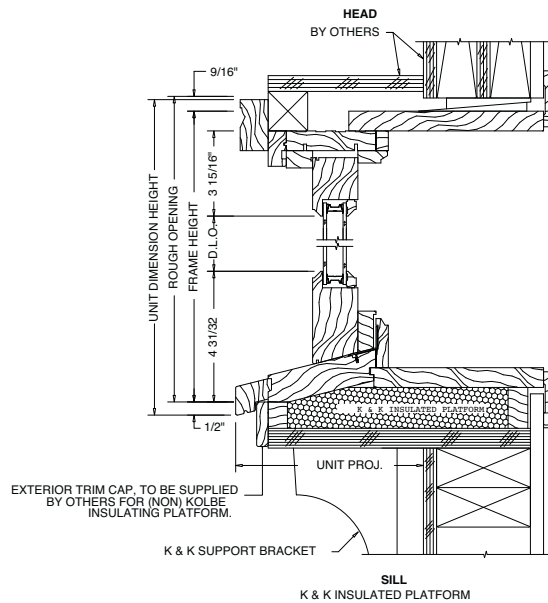

NOTE: Drawings are not to scale. Additional and the most current drawings are available in the Architect Library at www.kolbe-kolbe.com.

Double Hungs Cross Section Drawings

Traditional Double Hung 30° Bay Window

Horizontal Section

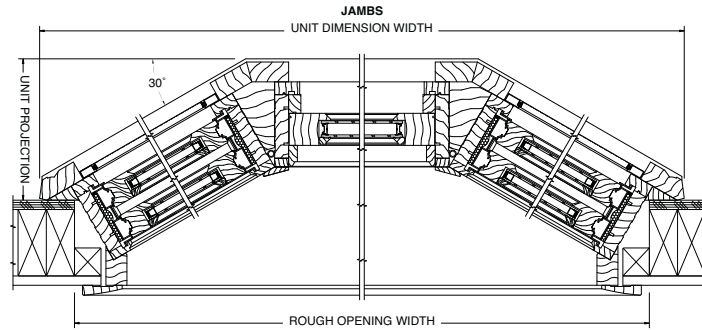

Traditional Double Hung 45° Bay Window

Horizontal Section

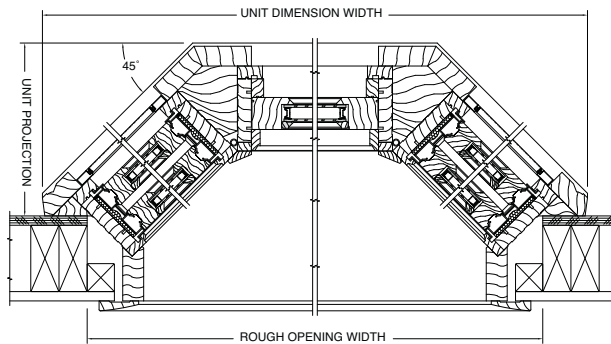

NOTE: Drawings are not to scale. Additional and the most current drawings are available in the Architect Library at www.kolbe-kolbe.com.

Magnum Double Hung

Vertical Section

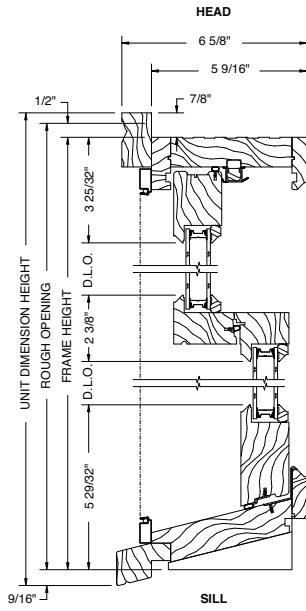

Horizontal Section

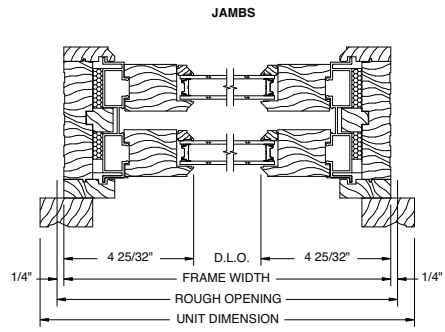

Narrow Mullion

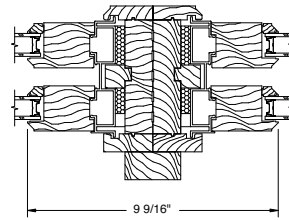

NOTE: Drawings are not to scale. Additional and the most current drawings are available in the Architect Library at www.kolbe-kolbe.com.

Double Hungs Cross Section Drawings

Dual Pane Majesta Double Hung

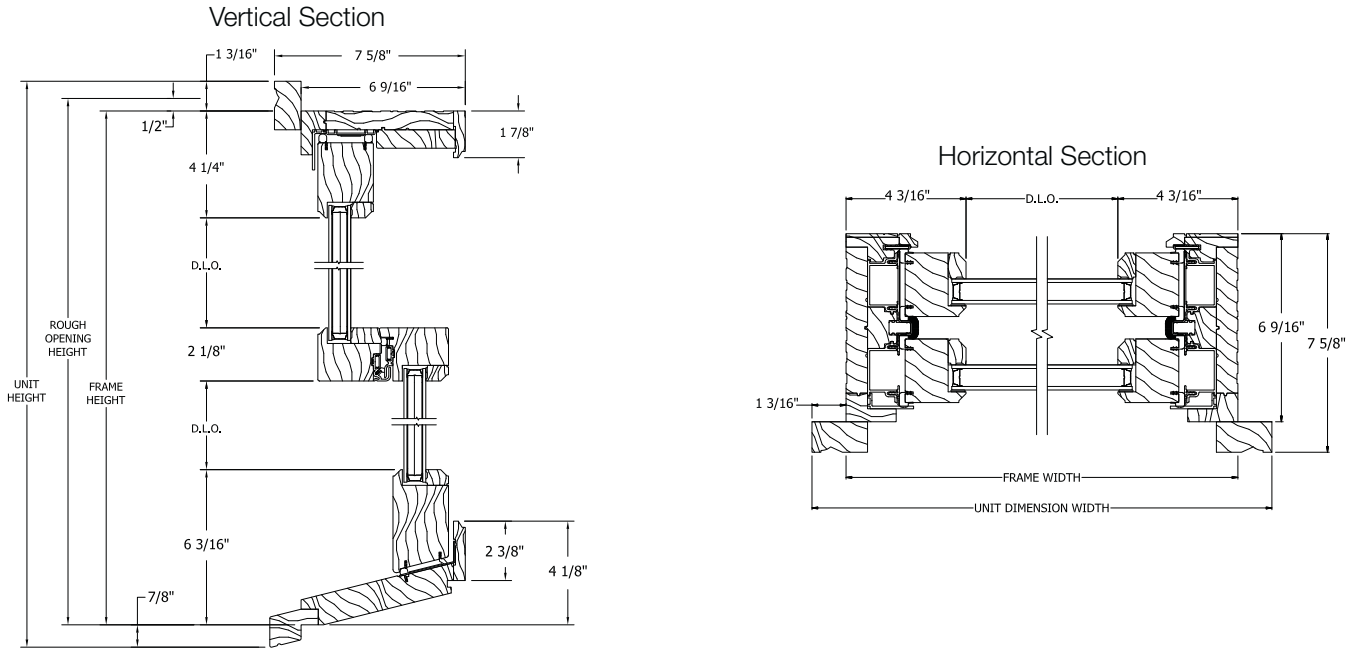

Triple Pane Majesta Double Hung

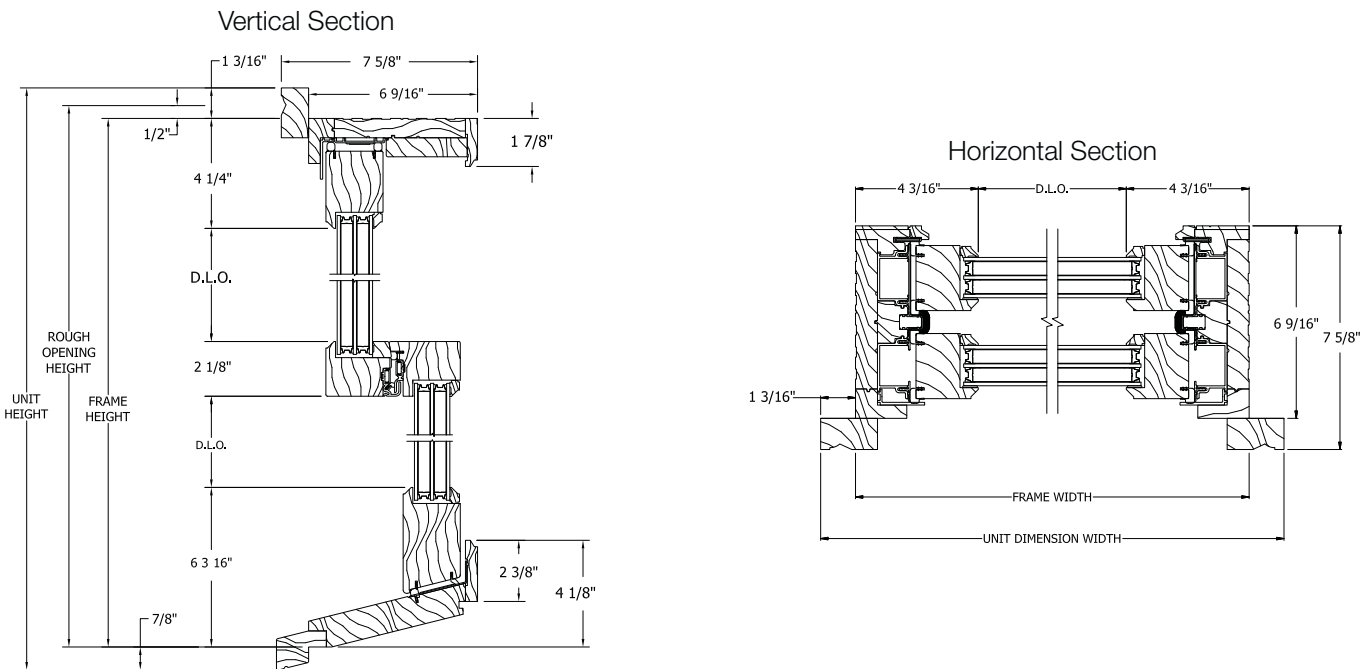

NOTE: There are no standard sizes for Majesta double hungs. Drawings are not to scale. Additional and the most current drawings are available in the Architect Library at www.kolbe-kolbe.com.

Old World Classic Double Hung

Vertical Section

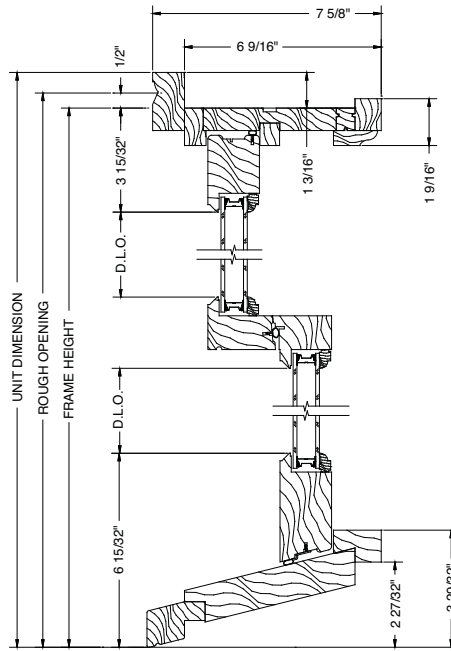

SILL

Horizontal Section

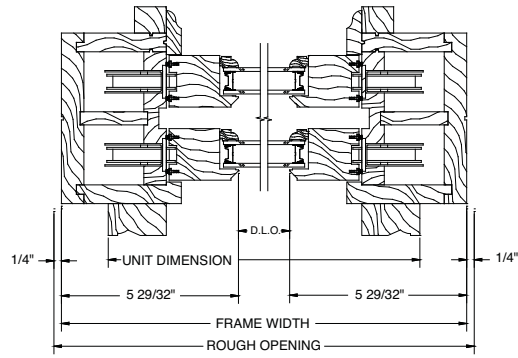

JAMB

NOTE: There are no standard sizes for Old World Classic double hungs. Drawings are not to scale. Additional and the most current drawings are available in the Architect Library at www.kolbe-kolbe.com.





Folding Windows, Tilt-Turns & Sliders

Kolbe is well-known in the window and door industry for innovative products. Folding windows are a perfect example, made for projects needing a pass-through type serving system. Our tilt-turns put a modern twist on a classic European window, with special hardware that allows them to open as a top-venting hopper window or an inswing casement. For traditionalists, Kolbe's slider windows offer a large, unobstructed view of the outdoors. Sash operate from side-to-side, making slider windows ideal for areas with limited space.

Folding Windows | Tilt-Turns | Traditional Double Sliders | Traditional Triple Sliders



Folding Windows



Folding windows can infuse a room with a remarkable amount of fresh air by offering openings up to 52 feet. With up to eight panels per side, folding windows are highly customizable with a number of different configurations available.

Folding Window Standard Features

- ▶ 1-3/4" thick sash
- ▶ 6-9/16" minimum jamb width
- ▶ Folding windows feature LVL locking stiles; stiles and rails are a nominal 3" wide
- ▶ Frame setup up to 177" wide x 77-1/8" tall; all others knocked down
- ▶ Constructed of pine with pine interior stops
- ▶ All exterior wood parts are preservative-treated
- ▶ Exterior frame is latex primed
- ▶ Energy efficient, insulating LoE²-270 glass
- ▶ Glazed to the interior with beveled wood glazing beads
- ▶ Fully weatherstripped for a tight seal
- ▶ Bronze weep sill
- ▶ Grooved guide rollers with adjustable, ball-bearing wheels carry the folding panels
- ▶ Multi-point* mortise latch with handle set in a Bright Brass finish
- ▶ Face-mounted flush bolt locking hardware on folding panels
- ▶ Thick oak interior threshold

NOTE: All measurements are nominal.

Minimum panel height is 36", minimum panel width is 16", maximum panel height is 72" and maximum panel width is 39-3/8".

* Minimum panel height for multi-point hardware is 36".

Hardware

Lock Bolts for Folding Panels



Flush Bolt
As standard, folding panels have surface-mounted flush bolts factory-applied. Sizes available include 7-1/2", 17-23/32" or 23-5/8". (shown in Matte Black; also available in Bright Brass, Chrome and Satin Nickel)



Concealed Shoot Bolt
Additionally, folding panels with concealed shoot bolts are available with an Uno or Aria handle set (below).

Handles for Folding Panels with Concealed Shoot Bolts

Folding panels with concealed shoot bolts are available with handles in two styles, Uno and Aria. Uno handles are available in Dull (Brushed) Chrome (shown) and Matte Black. Aria handles are available in Bright Brass, Chrome, Dull (Brushed) Chrome (shown) and Matte Black.

Uno

Aria



Handles for Swinging Panels

Folding windows can have a swinging panel for easy access. The swinging panel features a Toronto handle set as standard; other optional handle styles include, München, Dallas and Verona. Swinging panel hardware is available in numerous colors; see page 136 for handle style photos.



Folding Window Optional Features

Glass (pgs. 184-185):

- ▶ LoE-180
- ▶ LoE²-240
- ▶ LoE³-366
- ▶ ThermaPlus™ LoE
- ▶ Neat®
- ▶ Patterned, bronze- or gray-lite
- ▶ Laminated or tempered
- ▶ Other options standard to the industry

Divided Lites (pgs. 186-187):

- ▶ Performance divided lites with 5/8", 7/8", 1-1/8", 1-3/4", 2-1/4", or 4-1/2" bars
- ▶ True divided lites with 5/8" LoE² insulating glass and 1-1/8" bars
- ▶ Grilles-in-the-air-space
- ▶ Interior removable wood grilles with 7/8" or 1-1/8" bars and full surrounds

Exterior Finishes (pg. 189):

- ▶ Urethane primer
- ▶ K-Kron II exterior paint finish

Other Options: (custom options are also available)

- ▶ Stile and top rail options: 4-5/8" or 6"

NOTE: All measurements are nominal.

Hinge color options for folding windows include Bright Brass, Chrome, Satin Nickel and Matte Black.

Finger Pulls for Folding Windows

When panels are configured such that the final panel does not have a hinge handle to pull in the panel, a finger pull can be installed so that the panel can be pulled in and secured. Finger pulls are available in Bright Brass, Chrome, Satin Nickel (shown at right) and Matte Black.



- ▶ Bottom rail options: 4-5/8", 6", 7-9/16" or 12-5/8"
- ▶ 2-1/4" thick panel
- ▶ Other wood species and FSC-certified wood (pg. 188)
- ▶ Interior prefinishing (pg. 188)
- ▶ Interior casing (pg. 190)
- ▶ Ovolo and square profile glazing beads and interior divided lite bars (pg. 192)
- ▶ Single-point hardware for access panel
- ▶ Black pleated sliding screens only available on units with the frame setup
- ▶ Exterior brickmoulds and casing (pg. 190)
- ▶ Toronto, Verona, Dallas or München handle set for access panel (pg. 136)
- ▶ Concealed shootbolt locking hardware for folding panels
- ▶ Uno or Aria handle set for folding panels with concealed shoot bolts
- ▶ Recessed floor track sill (interior), weep or non-weep in Bronze Anodized finish
- ▶ Recessed weep sill, Bronze Anodized finish
- ▶ Weep sill, Clear Anodized finish
- ▶ Extension jambs in a wide variety of sizes (shipped loose for field application if over 12")
- ▶ Galvanized steel installation clips
- ▶ Magnetic latch available to assist in keeping windows stationary while open

Magnetic Latch for Folding Windows

When panels are in an open position, some movement can occur due to wind or other factors. When magnetic latches are attached to the panel, the panels remain stationary. The purpose of this latch is to prevent movement, thereby keeping the panels in a fully open position.



Tilt-Turns



Tilt-turns put a modern twist on a classic European window. These units have special hardware that allows them to operate as a top-venting hopper window or an inswing casement. Tilt-turns combine versatility with classic style.

Tilt-Turn Standard Features

- ▶ Sash are 2-1/4" thick with 3-1/4" wide stiles and rails
- ▶ Basic frame jamb width is 2-7/16"
- ▶ Finished frame jamb width is 4-9/16"
- ▶ Constructed of pine, with pine interior stops and wood mull casings on muller units
- ▶ Energy efficient, insulating LoE²-270 glass
- ▶ Glazed to the interior with ovolo-profiled wood glazing beads
- ▶ 1-15/16" exterior brickmould applied to finished frame units
- ▶ All exterior wood parts are preservative-treated
- ▶ Exterior frame and sash are latex primed
- ▶ Fully weatherstripped for a tight seal
- ▶ Solid brass handles with a Bright Brass finish
- ▶ Unit can be operated as a hopper and inswing casement

NOTE: All measurements are nominal.

Hardware

Tilt-Turn windows have a solid, Bright Brass handle set as standard. Other handle options include solid brass with an Antique Brass finish or aluminum alloy with a White or Bronze-colored finish. Oil-Rubbed* and custom finish options are also available. Keyed handles in the same finishes are available as well.



*The Oil-Rubbed finish is a living finish, which means that it will change appearance over time with use.



Hopper operation



Inswing operation



Tilt-Turn Optional Features

Glass (pgs. 184-185):

- ▶ LoE -180
- ▶ LoE² -240
- ▶ LoE³ -366
- ▶ ThermaPlus™ LoE
- ▶ Patterned, bronze- or gray-lite
- ▶ Tempered or laminated
- ▶ Other options standard to the industry

Divided Lites (pgs. 186-187):

- ▶ Performance divided lites with 5/8", 7/8", 1-1/8", 1-3/4", 2-1/4", or 4-1/2" bars
- ▶ Grilles-in-the-airspace
- ▶ Interior removable wood grilles with 7/8" or 1-1/8" bars and full surrounds

Exterior Finishes (pg. 189):

- ▶ K-Kron II exterior paint finish

Other Options: (custom options are also available)

- ▶ Other wood species and FSC-certified wood (pg. 188)
- ▶ Interior prefinishing (pg. 188)
- ▶ Interior casing (pg. 190)
- ▶ 3-1/2" flat or profiled brickmould, backband on 3-1/2" brickmould and other custom millwork (pg. 190)
- ▶ Projected sill nosing, extended sill horns or no nosing on finished units
- ▶ Beveled and square profile glazing beads and interior divided lite bars (pg. 192)
- ▶ Solid brass handles with an Antique Brass finish, or aluminum alloy handles in either a White or Bronze-colored finish. Oil-Rubbed* finish is also available.
- ▶ Keyed handles, either solid brass with a Bright Brass or Antique Brass finish, or aluminum alloy with either a White or Bronze-colored finish. Oil-Rubbed* finish is also available.
- ▶ Screens with BetterVue® or UltraVue® fiberglass screen mesh, or aluminum screen mesh
- ▶ Unit operation as hopper only or inswing only
- ▶ Extension jambs for finished units (up to 4-9/16" applied to the exterior over 4-9/16" applied to the interior)
- ▶ Galvanized steel installation clips

NOTE: All measurements are nominal.

*The Oil-Rubbed finish is a living finish, which means that it will change appearance over time with use.

Sliders



Sliders create a streamlined look with simple functionality, which makes them ideal for hard-to-reach spaces or behind furniture. Sash can be easily removed for convenient cleaning.

Slider Standard Features

- ▶ 1-3/8" thick sash
- ▶ Energy efficient, insulating LoE²-270 glass
- ▶ Overall jamb width is 4-9/16" (*basic box width is 4-9/16"*)
- ▶ Constructed of pine, with pine interior stops
- ▶ Glazed to the interior with beveled wood glazing beads
- ▶ 1-15/16" exterior brickmould applied
- ▶ All exterior wood parts are preservative-treated
- ▶ Exterior frame and sash are latex primed
- ▶ Rigid PVC waterseal at the sill
- ▶ Fully weatherstripped for a tight seal
- ▶ Clay-colored heavy duty sash locks
- ▶ Machined finger grooves on the outermost stiles
- ▶ Beige extruded vinyl head and sill tracks with compression foam backing on the head track

NOTE: All measurements are nominal.

1-15/16" brickmould applied as standard



Hardware

Clay-colored cam locks are factory-applied to slider units as standard. Other finishes available are White, Beige, Brass, Antique Brass, Rustic Umber, Satin Nickel, Antique Nickel, Oil-Rubbed* and Matte Black.

*The Oil-Rubbed finish is a living finish, which means that it will change appearance over time with use.



Clay (standard)

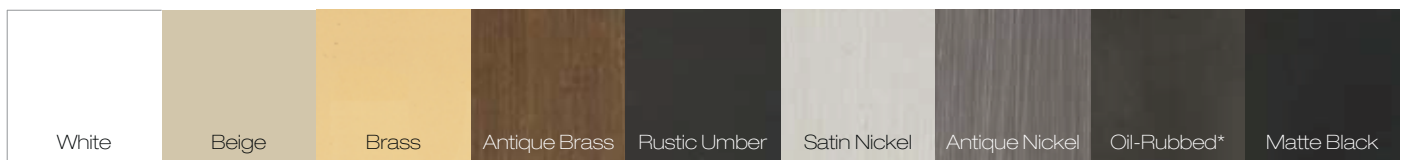



Slider Optional Features

Glass (pgs. 184-185):

- ▶ LoE-180
- ▶ LoE²-240
- ▶ LoE³-366
- ▶ ThermaPlus™ LoE
- ▶ Patterned, bronze- or gray-lite
- ▶ Tempered or laminated
- ▶ Other options standard to the industry

Divided Lites (pgs. 186-187):

- ▶ Performance divided lites with 5/8", 7/8", 1-1/8", 1-3/4", 2-1/4", or 4-1/2" bars
- ▶ True divided lites with 1/2" LoE² insulating glass and 1-1/8" bars
- ▶ Grilles-in-the-air-space
- ▶ Interior removable wood grilles with 7/8" or 1-1/8" bars and full surrounds

Exterior Finishes (pg. 189):

- ▶ K-Kron II exterior paint finish

Other Options: (custom options are also available)

- ▶ Other wood species and FSC-certified wood (pg. 188)
- ▶ Interior prefinishing (pg. 188)
- ▶ Interior casing (pg. 190)
- ▶ Prep for stool
- ▶ 3-1/2" flat or profiled brickmould, backband on 3-1/2" brickmould and other custom millwork (pg. 190)
- ▶ Projected sill nosing, extended sill horns or no nosing
- ▶ Ovolo and square profile glazing beads and interior divided lite bars (pg. 192)
- ▶ Sash locks in White, Beige, Brass, Antique Brass, Satin Nickel, Antique Nickel, Rustic Umber, Oil-Rubbed* and Matte Black finishes
- ▶ Full screens or half screens with aluminum frames and options for BetterVue® or UltraVue® fiberglass screen mesh or aluminum screen mesh; frames will match the exterior color of the unit
- ▶ StormGuard combination storm/screen units (pg. 191)
- ▶ Extension jambs (up to 12" applied; over 12" shipped loose for field application)
- ▶ Galvanized steel installation clips

NOTE: All measurements are nominal.

*The Oil-Rubbed finish is a living finish, which means that it will change appearance over time with use.

Folding Windows Panel Configurations

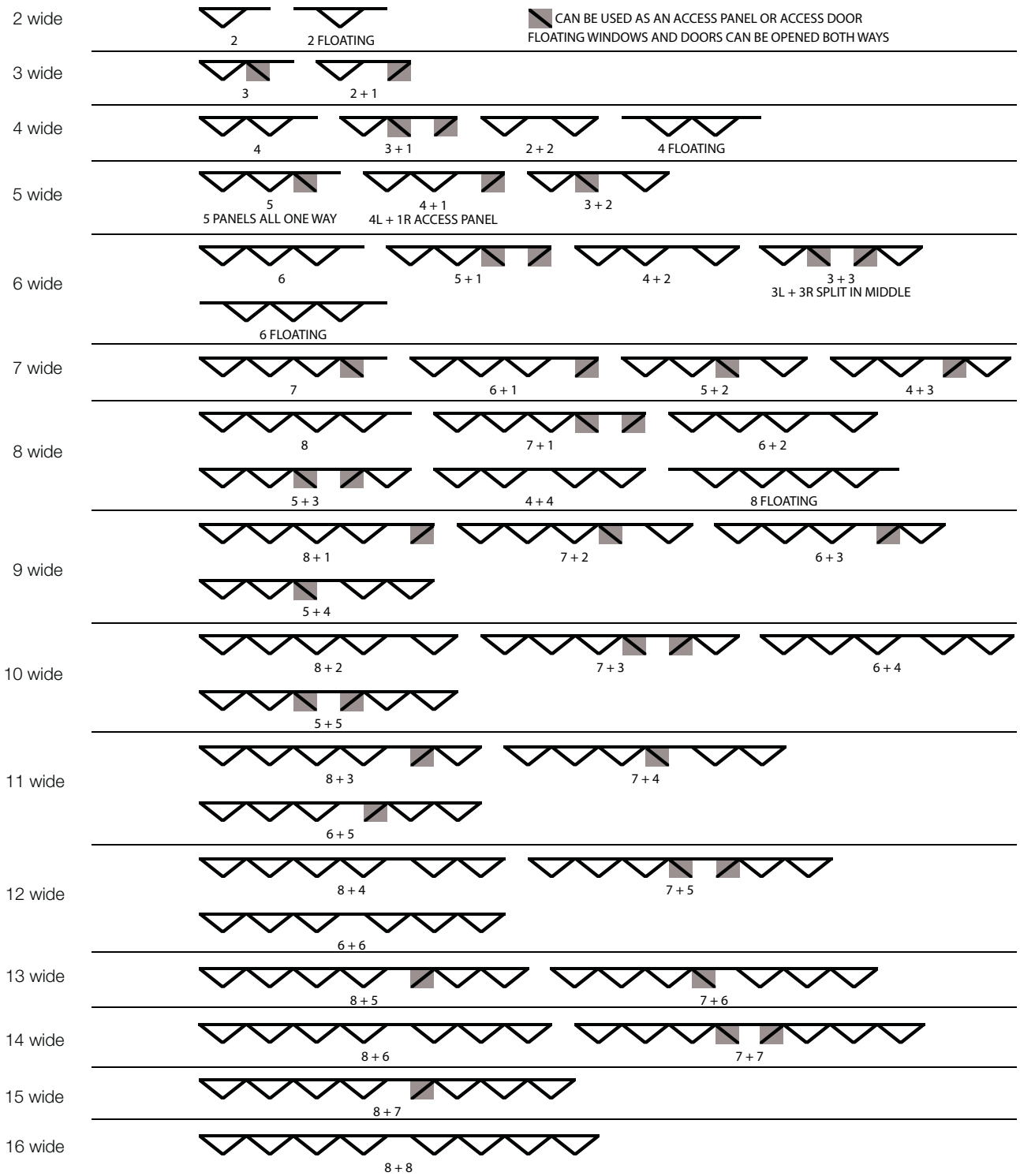

Folding Windows Cross Section Drawings

Four-Wide: Folding One-Way

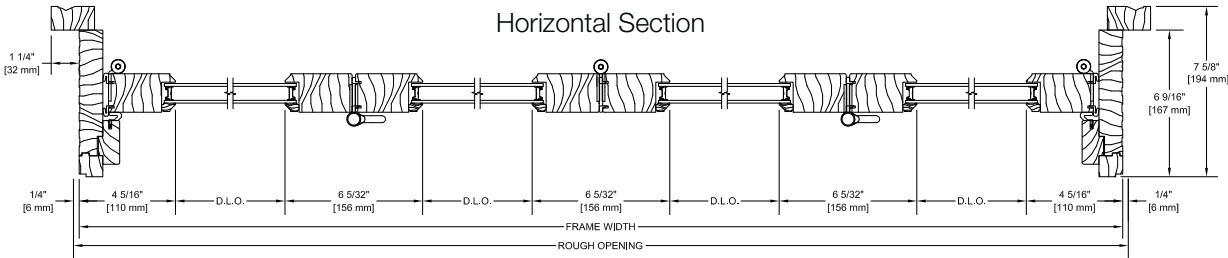

Four-Wide: One Left & Three Right

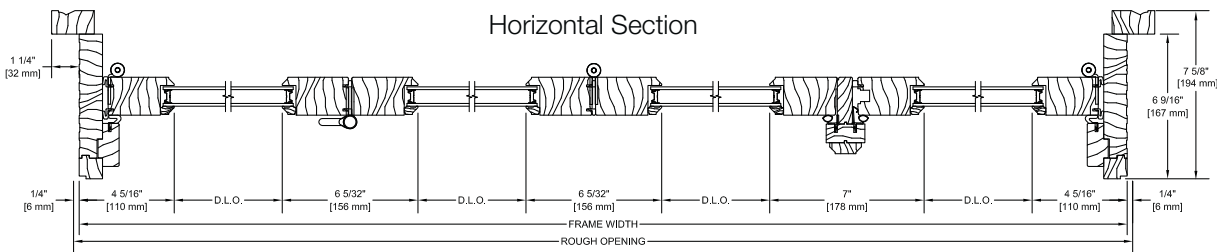

Four-Wide: Two Left & Two Right

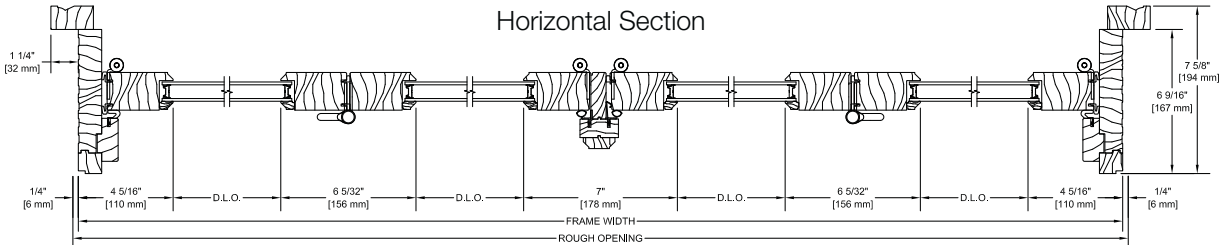

Operation is viewed from the exterior.

NOTE: Drawings are not to scale. Additional and the most current drawings are available in the Architect Library at www.kolbe-kolbe.com.

Tilt-Turns | Cross Section Drawings

Tilt-Turn Basic Frame

Vertical Section

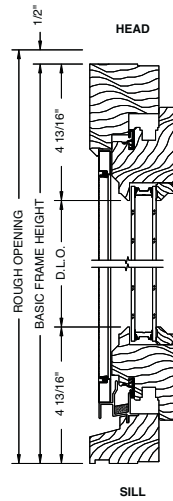

Horizontal Section

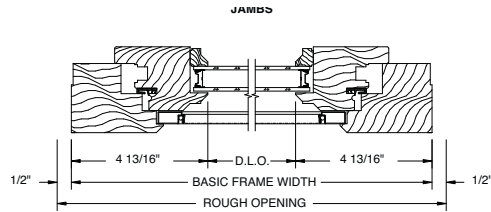

Mullion

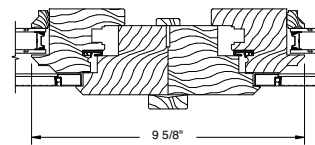

Tilt-Turn Finished Frame

Vertical Section

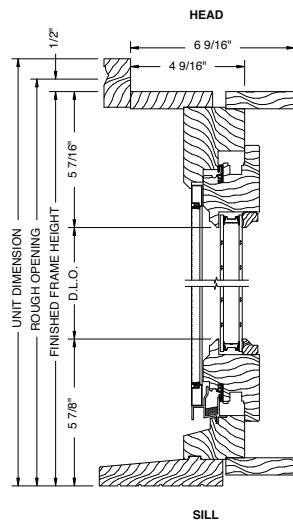

Horizontal Section

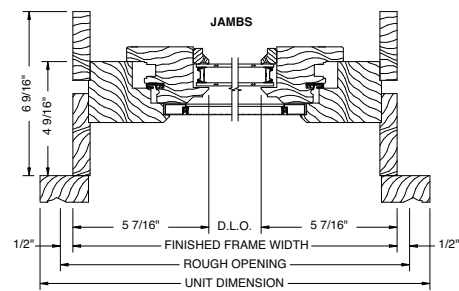

Mullion

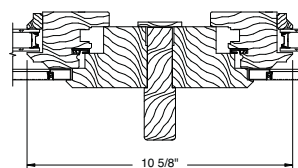

NOTE: Drawings are not to scale. Additional and the most current drawings are available in the Architect Library at www.kolbe-kolbe.com.

Sliders | Elevation Charts

Double Sliders

	3'-4 7/8"	4'-0 7/8"	4'-8 7/8"	5'-4 7/8"	6'-0 7/8"
U.D.	3'-4 7/8"	4'-0 7/8"	4'-8 7/8"	5'-4 7/8"	6'-0 7/8"
R.O.	3'-3"	3'-11"	4'-7"	5'-3"	5'-11"
S.O.	3'-1"	3'-9"	4'-5"	5'-1"	5'-9"
G.S.	16" 16"	20" 20"	24" 24"	28" 28"	32" 32"
2'-0 1/2"					
2'-4 1/2"					
2'-8 1/2"					
3'-0 1/2"					
3'-4 1/2"					
3'-8 1/2"					
4'-0 1/2"					
4'-4 1/2"					
4'-8 1/2"					

NOTE: All measurements are nominal. Elevation charts are not to scale.

Divided lites are optional.

Some installation procedures will require a larger rough opening than noted (i.e. installations utilizing our installation clips), therefore, you may need to increase the rough opening size accordingly. Rough opening gaps may be increased up to a maximum of 1/2" on all sides and still be within good practice guidelines. For rough opening recommendations, see pg. 196.

The side jambs of slider units extend above the head jamb; additional space for the rough opening height may be necessary.

* Units meet most national emergency escape and rescue requirements.

PRODUCT CODES:

To order, add "W" before the product number (Ex: WSL3248).

U.D. = Unit Dimension • R.O. = Rough Opening • S.O. = Sash Opening • G.S. = Glass Size

Triple Sliders

	6'-1 7/8"	7'-5 7/8"	8'-1 7/8"	8'-9 7/8"
U.D.	6'-0"	7'-4"	8'-0"	8'-8"
R.O.	5'-10"	7'-2"	7'-10"	8'-6"
S.O.	16" 31 1/2" 16"	20" 39 1/2" 20"	20" 47 1/2" 20"	24" 47 1/2" 24"
G.S.				
3'-4 1/2"				
3'-3 3/8"				
3'-1"				
31 1/2"				
4'-0 1/2"				
3'-11 3/8"				
3'-9"				
39 1/2"				
4'-4 1/2"				
4'-3 3/8"				
4'-1"				
43 1/2"				
4'-8 1/2"				
4'-7 3/8"				
4'-5"				
47 1/2"				

Dimension Calculations

Elevation charts provide wood unit dimensions for units with the standard 1 15/16" brickmould. Below are the calculations to determine the frame size of units with brickmould.

	Width	Height
1-15/16" brickmould; U.D. to F.S.	-2 3/8"	-1 11/16"
3-1/2" flat or profiled casing; U.D. to F.S.	-5 1/2"	-3 1/4"
3-1/2" casing and backband; U.D. to F.S.	-7"	-4 3/16"

F.S. to S.O.	-1 1/2"	-1 13/16"
R.O. to G.S.	-7" ÷2	-7 3/8"
G.S. to D.L.O.	-1"	-1"

Note: Clear opening dimensions can be found on pg. 202.

F.S. = Frame Size • G.S. = Glass Size • S.O. = Sash Opening
 R.O. = Rough Opening • D.L.O. = Daylight Opening
 U.D. = Unit Dimension

NOTE: All measurements are nominal. Elevation charts are not to scale.

Divided lites are optional.

Some installation procedures will require a larger rough opening than noted (i.e. installations utilizing our installation clips), therefore, you may need to increase the rough opening size accordingly. Rough opening gaps may be increased up to a maximum of 1/2" on all sides and still be within good practice guidelines. For rough opening recommendations, see pg. 196.

The side jambs of slider units extend above the head jamb; additional space for the rough opening height may be necessary.

* Units meet most national emergency escape and rescue requirements.















PRODUCT CODES:

To order, add "W" before the product number (Ex: WTSL244848).

U.D. = Unit Dimension • R.O. = Rough Opening • S.O. = Sash Opening • G.S. = Glass Size

Sliders | Elevation Charts

Sliders | Remodeling Sizes

	2'-1 7/8"	3'-1 7/8"	4'-1 7/8"	5'-1 7/8"	6'-1 7/8"	8'-1 7/8"
U.D.	2'-0"	3'-0"	4'-0"	5'-0"	6'-0"	8'-0"
R.O.	2'-0"	3'-0"	4'-0"	5'-0"	6'-0"	8'-0"
S.O.	1'-10"	2'-10"	3'-10"	4'-10"	5'-10"	7'-10"
G.S.	8 1/2" 8 1/2"	14 1/2" 14 1/2"	20 1/2" 20 1/2"	26 1/2" 26 1/2"	32 1/2" 32 1/2"	20" 47 3/4" 20"
2'-1 1/8"						
3'-1 1/8"						
4'-1 1/8"						
5'-1 1/8"						

NOTE: All measurements are nominal. Elevation charts are not to scale.

Divided lites are optional.

Some installation procedures will require a larger rough opening than noted (i.e. installations utilizing our installation clips), therefore, you may need to increase the rough opening size accordingly. Rough opening gaps may be increased up to a maximum of 1/2" on all sides and still be within good practice guidelines. For rough opening recommendations, see pg. 196.

The side jambs of slider units extend above the head jamb; additional space for the rough opening height may be necessary.

* Units meet most national emergency escape and rescue requirements.

PRODUCT CODES:

To order, add "ARW" before the product number (Ex: ARWTSLSL8050).

U.D. = Unit Dimension • R.O. = Rough Opening • S.O. = Sash Opening • G.S. = Glass Size

Sliders | Cross Section Drawings

Double Slider

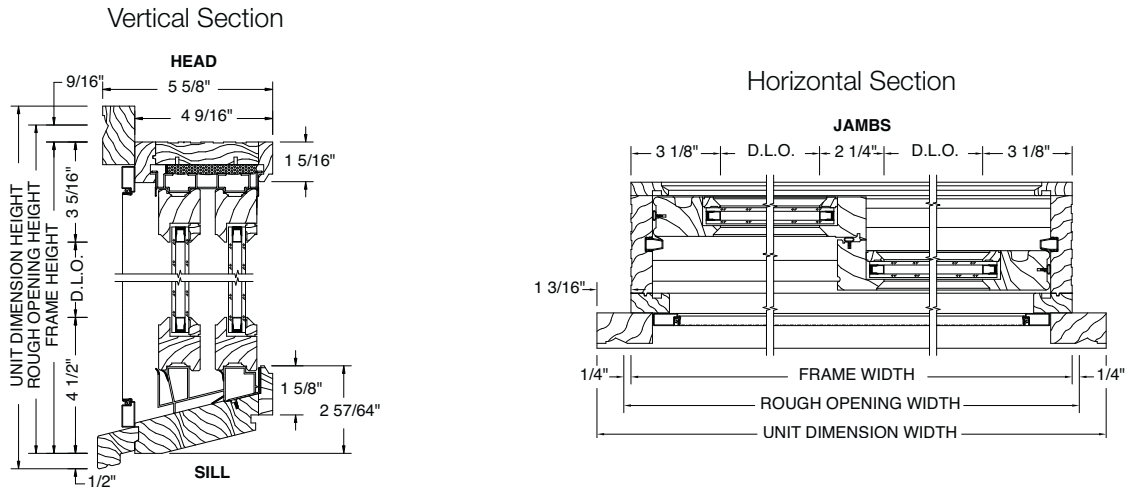

Triple Slider

Horizontal Section

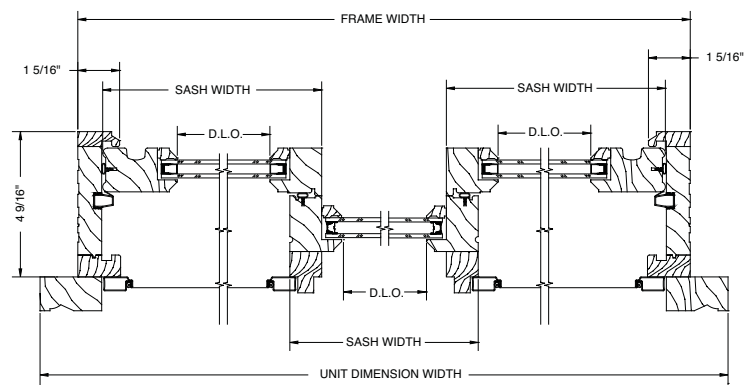

NOTE: Drawings are not to scale. Additional and the most current drawings are available in the Architect Library at www.kolbe-kolbe.com.



RECREATIONAL EQUIPMENT

THE DENVER TRAMWAY POWER CO.
1861

STARBUCKS
COFFEE



Complementary Windows

Heritage Series complementary windows are available in a variety of sizes and styles. Add radius or geometric units to other windows and doors to make that final dramatic statement to your design. To achieve a unique look, choose Kolbe's radius windows. Half-circle or elliptical units stacked above other Kolbe windows and doors create gracious curves and allow more light to enter your room. Make your design truly distinctive with Kolbe's geometric windows. Any combination will provide a light-filled room and a terrific view. Comprise a window wall with a variety of triangles, trapezoids, parallelograms, octagons, pentagons, diamonds, hexagons or any shape you can imagine to create a unique space that is sure to be eye-catching.

Radius Windows | Geometric Windows



Radius Windows



Kolbe makes radius windows in stand-alone full circles, half-circles, quarter-circles, elliptical, ovals and custom shapes. Half-circle or elliptical windows can be stacked over other Kolbe windows and doors to create larger window walls. We build our radius windows to order so that their profiles match those of the windows they complement.

Radius Standard Features

- ▶ 1-3/4" thick sash
- ▶ Overall jamb width is 4-9/16"; 5-9/16" for Magnum radius units *(basic box width matches the unit being complemented)*
- ▶ 3" straight legs on half-circles
- ▶ Constructed of pine, with pine interior stops and wood mull casings on mull units
- ▶ Energy efficient, insulating LoE²-270 glass
- ▶ Glazing is sash set to the interior with beveled wood glazing beads
- ▶ 1-15/16" exterior brickmould applied
- ▶ All exterior wood parts are preservative-treated
- ▶ Exterior frame and sash are latex primed
- ▶ Fully weatherstripped for a tight seal

NOTE: All measurements are nominal.

1-15/16" brickmould applied as standard





Radius Optional Features

Glass (pgs. 184-185):

- ▶ LoE-180
- ▶ LoE² -240
- ▶ LoE³ -366
- ▶ ThermaPlus™ LoE
- ▶ Patterned, bronze- or gray-lite
- ▶ Tempered or laminated
- ▶ Other options standard to the industry

Divided Lites (pgs. 186-187):

- ▶ Performance divided lites with 5/8", 7/8", 1-1/8", 1-3/4", 2-1/4", or 4-1/2" bars
- ▶ True divided lites with 5/8" LoE² insulating glass and 1-1/8" bars
- ▶ Grilles-in-the-air-space
- ▶ Interior removable wood grilles with 7/8" or 1-1/8" bars and full surrounds

Exterior Finishes (pg. 189):

- ▶ K-Kron II exterior paint finish

NOTE: All measurements are nominal.

Other Options: (custom options are also available)

- ▶ Custom shapes such as bell-tops and gothic-tops
- ▶ Other wood species and FSC-certified wood (pg. 188)
- ▶ Interior prefinishing (pg. 188)
- ▶ Interior casing (pg. 190)
- ▶ 3-1/2" flat or profiled brickmould, backband on 3-1/2" brickmould and other custom millwork (pg. 190)
- ▶ Projected sill nosing, extended sill horns or no nosing
- ▶ Ovolo and square profile glazing beads and interior divided lite bars (pg. 192)
- ▶ Glazing may be direct set
- ▶ Extended legs or no legs on half-circles
- ▶ Extension jambs (up to 12" applied; over 12" shipped loose for field application)
- ▶ Galvanized steel installation clips
- ▶ High performance or K-Force® impact performance modifications

Geometric Windows



Geometric Units

Angled for interest, geometric windows are attention-grabbers. Kolbe can produce a nearly infinite variety of window shapes and sizes, with a vast array of glazing options. Geometric units are sash set as standard and built with specifications to complement our standard windows and doors. We take the time to make sure the profiles of the specific geometric unit chosen closely match the unit it is milled to or aligned with. We offer geometric windows in triangles, octagons, hexagons, pentagons, trapezoids and diamonds. If you're envisioning a different shape, we also build custom shapes. Decorative 1-15/16" brickmould and sill nose trim are applied to wood unit exteriors. Many glazing, divided lite and exterior finish options are available on Kolbe geometric windows, however, certain options may depend on the shape of the unit ordered. Contact your dealer about adding Kolbe custom geometric windows to your plans.





Radius | Elevation Charts

Radius Divided Lite Patterns

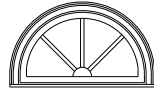

Sunburst

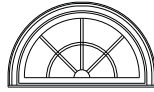

Double Cut
Sunburst

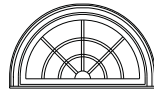

Triple Cut
Sunburst

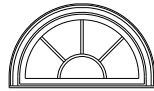

Open Hub
Sunburst

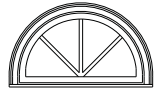

Starburst



Spider
Web

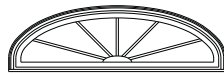

Elliptical
Sunburst

NOTE:
2-1/4" PDL bars are not available for patterns with curved bars.
Some designs may have a composite material for the exterior
PDL bar.

Dimension Calculations

Dimension calculation formulas for radius units vary depending on the unit and application. Please contact your Kolbe dealer if formulas are needed.

Half-Circle Units | Casement

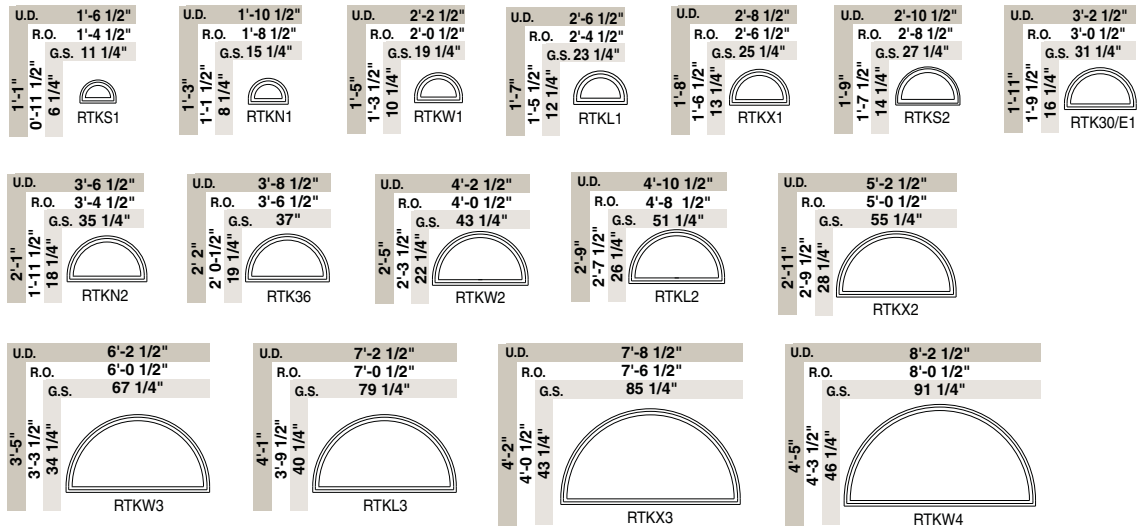

Half-Circle Units | Double Hung

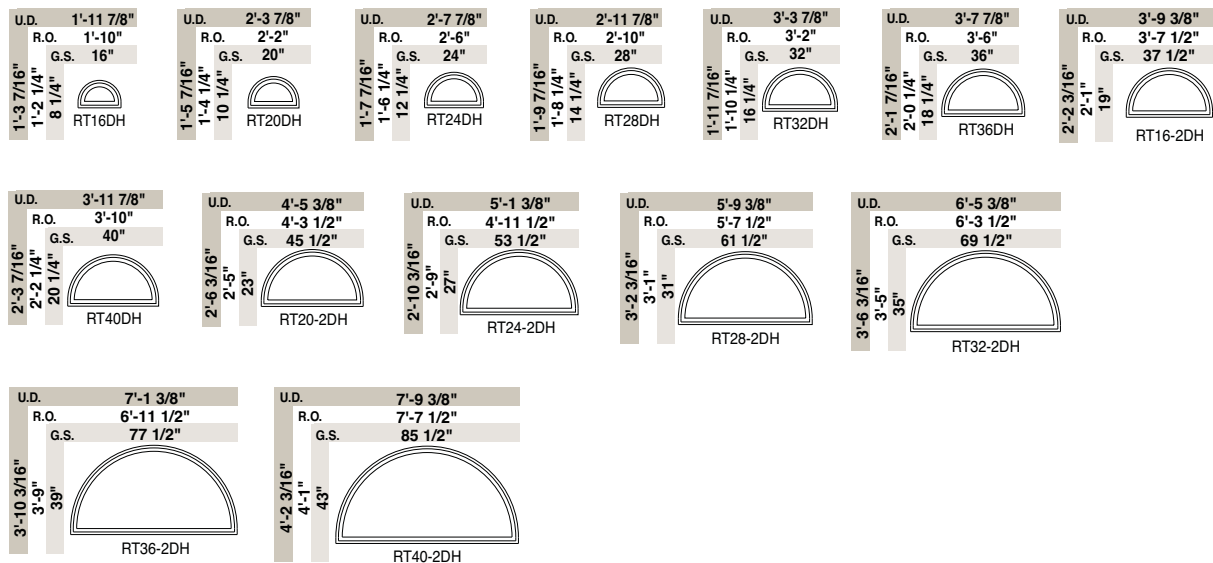

NOTE: All measurements are nominal. Elevation charts are not to scale.

Radius units are sash set as standard. Direct set units are available. Glass sizes differ for direct set units. Contact your supplier for details.

The units shown are stand-alone units. Adjustments may be required when stacking over other units; adjustments will be made in the factory.

Divided lites are optional. Divided lite pattern options are shown on pg. 120.

Some installation procedures will require a larger rough opening than noted (i.e. installations utilizing our installation clips), therefore, you may need to increase the rough opening size accordingly. Rough opening gaps may be increased up to a maximum of 1/2" on all sides and still be within good practice guidelines. For rough opening recommendations, see pg. 196.

Product Codes:

To order, add "W" before the product number (Ex: WRTKW4).

U.D. = Unit Dimension • R.O. = Rough Opening • G.S. = Glass Size

Radius | Elevation Charts

Half-Circle Units | Magnum Double Hung

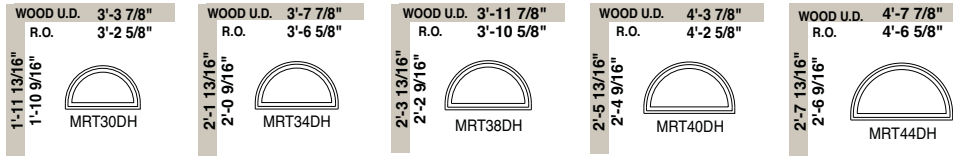

Half-Circle Units | Garden-Aire Sliding Patio Door

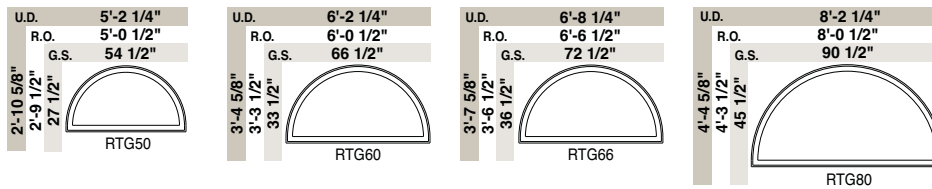

Half-Circle Units | Inswing Patio Door

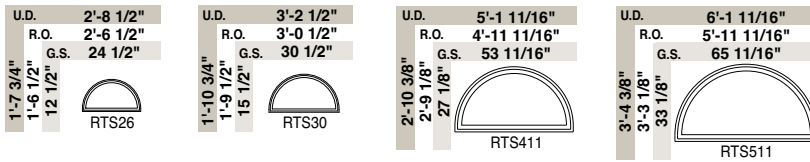

Half-Circle Units | Inswing Exterior Door

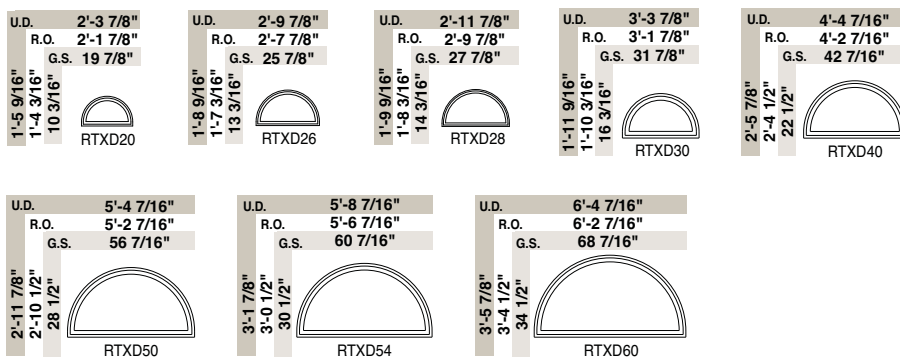

NOTE: All measurements are nominal. Elevation charts are not to scale.

Radius units are sash set as standard. Direct set units are available. Glass sizes differ for direct set units. Contact your supplier for details.

The units shown are stand-alone units. Adjustments may be required when stacking over other units; adjustments will be made in the factory.

Divided lites are optional. Divided lite pattern options are shown on pg. 120.

Some installation procedures will require a larger rough opening than noted (i.e. installations utilizing our installation clips), therefore, you may need to increase the rough opening size accordingly. Rough opening gaps may be increased up to a maximum of 1/2" on all sides and still be within good practice guidelines. For rough opening recommendations, see pg. 196.

PRODUCT CODES:

To order, add "W" before the product number. (Ex: WRTG80). Specify inswing entrance door when ordering inswing entrance door half-circles.

U.D. = Unit Dimension • R.O. = Rough Opening • G.S. = Glass Size

Half-Circle Units | One-Wide Outswing Entrance Door

(for active door)

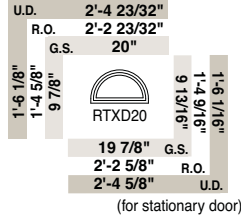

(for active door)

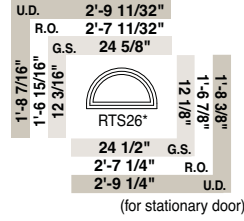

(for active door)

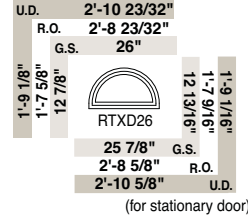

(for active door)

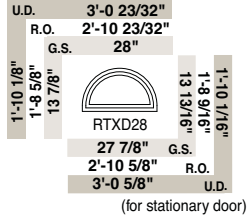

(for active door)

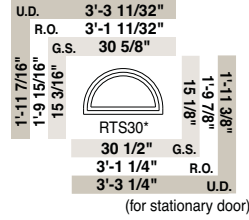

(for active door)

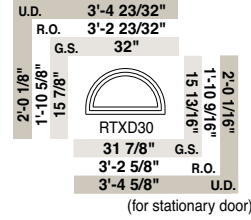

Half-Circle Units | Two-Wide Outswing Entrance Door

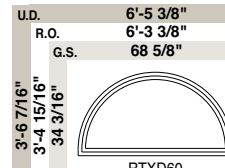
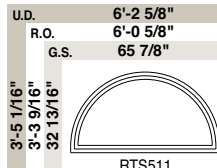
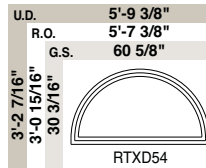
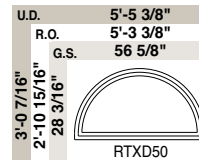
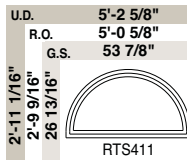
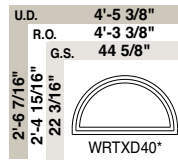

NOTE: All measurements are nominal. Elevation charts are not to scale.

Radius units are sash set as standard. Direct set units are available. Glass sizes differ for direct set units. Contact your supplier for details.

The units shown are stand-alone units. Adjustments may be required when stacking over other units; adjustments will be made in the factory.

Divided lites are optional. Divided lite pattern options are shown on pg. 120.

Some installation procedures will require a larger rough opening than noted (i.e. installations utilizing our installation clips), therefore, you may need to increase the rough opening size accordingly. Rough opening gaps may be increased up to a maximum of 1/2" on all sides and still be within good practice guidelines. For rough opening recommendations, see pg. 196.

* Patio door sizes

PRODUCT CODES:

To order, add "W" before the product number (Ex: WRTXD26). Specify outswing, active or stationary.

U.D. = Unit Dimension • R.O. = Rough Opening • G.S. = Glass Size

Radius | Elevation Charts

Elliptical Units | Casement

U.D.	4'-2 1/2"	5'-2 1/2"	6'-2 1/2"	7'-8 1/2"	8'-2 1/2"
R.O.	4'-0 1/2"	5'-0 1/2"	6'-0 1/2"	7'-6 1/2"	8'-0 1/2"
G.S.	43 1/4"	55 1/4"	67 1/4"	85 1/4"	91 1/4"

Elliptical Units | Double Hung

U.D.	3'-9 3/8"	4'-5 3/8"	5'-1 3/8"	5'-9 3/8"	6'-5 3/8"	7'-1 3/8"	7'-9 3/8"
R.O.	3'-7 1/2"	4'-3 1/2"	4'-11 1/2"	5'-7 1/2"	6'-3 1/2"	6'-11 1/2"	7'-7 1/2"
G.S.	37 1/2"	45 1/2"	53 1/2"	61 1/2"	69 1/2"	77 1/2"	85 1/2"

U.D.	5'-6 7/8"	6'-6 7/8"	7'-6 7/8"	8'-6 7/8"	9'-6 7/8"	10'-6 7/8"
R.O.	5'-5"	6'-5"	7'-5"	8'-5"	9'-5"	10'-5"
G.S.	59"	71"	83"	95"	107 1/8"	119"

Elliptical Units | Garden-Aire Sliding Patio Door

U.D.	5'-2 1/4"	6'-2 1/4"	6'-8 1/4"	8'-2 1/4"
R.O.	5'-0 1/2"	6'-0 1/2"	6'-6 1/2"	8'-0 1/2"
G.S.	54 1/2"	66 1/2"	72 1/2"	90 1/2"

Elliptical Units | Inswing Patio Door

U.D.	5'-1 7/16"	6'-1 7/16"
R.O.	4'-11 11/16"	5'-11 11/16"
G.S.	53 11/16"	65 11/16"

Elliptical Units | Inswing Entrance Door

U.D.	4'-4 3/16"	5'-4 3/16"	5'-8 3/16"	6'-4 3/16"
R.O.	4'-2 7/16"	5'-2 7/16"	5'-6 7/16"	6'-2 7/16"
G.S.	44 9/16"	56 9/16"	60 9/16"	68 9/16"

Elliptical Units | Outswing Entrance Door

U.D.	4'-5 3/8"	5'-5 3/8"	5'-9 3/8"	6'-5 3/8"
R.O.	4'-3 3/8"	5'-3 3/8"	5'-7 3/8"	6'-3 3/8"
G.S.	44 5/8"	56 5/8"	60 5/8"	68 5/8"

Elliptical Units | Outswing Patio Door

U.D.	5'-2 5/8"	6'-2 5/8"
R.O.	5'-0 5/8"	6'-0 5/8"
G.S.	53 15/16"	65 15/16"

NOTE: All measurements are nominal. Elevation charts are not to scale.

Radius units are sash set as standard. Direct set units are available. Glass sizes differ for direct set units. Contact your supplier for details.

The units shown are stand-alone units. Adjustments may be required when stacking over other units; adjustments will be made in the factory.

Divided lites are optional. Divided lite pattern options are shown on pg. 120.

Some installation procedures will require a larger rough opening than noted (i.e. installations utilizing our installation clips), therefore, you may need to increase the rough opening size accordingly. Rough opening gaps may be increased up to a maximum of 1/2" on all sides and still be within good practice guidelines. For rough opening recommendations, see pg. 196.

PRODUCT CODES:

Product codes that begin with "W" are units available as wood or clad profile. Specify when ordering. Product codes that begin with "E" are units available as wood only. Add "W" before the product code when ordering. For elliptical units above doors specify inswing patio or entrance, outswing patio or outswing entrance.

U.D. = Unit Dimension • R.O. = Rough Opening • G.S. = Glass Size

Quarter-Circle Units | Casement

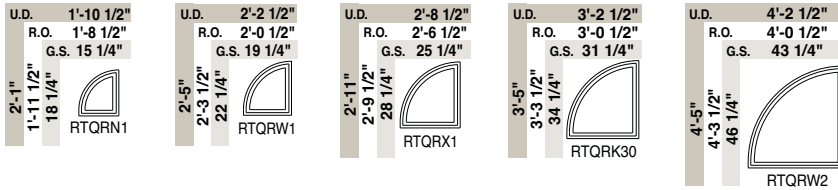

Quarter-Circle Units | Double Hung

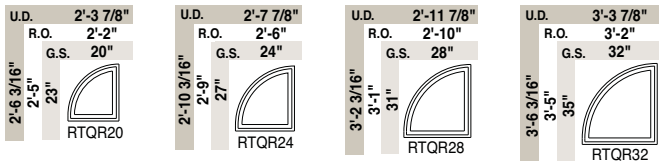

Full Circle Units

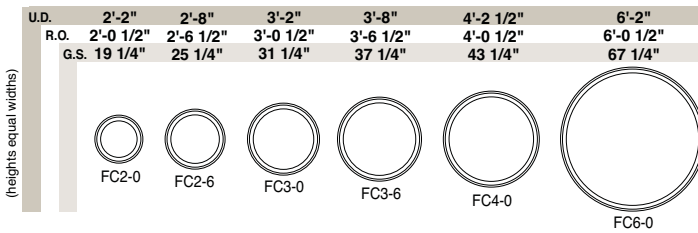

Oval Units

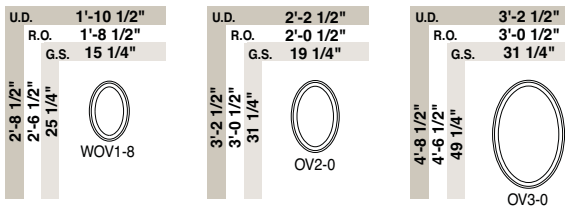

NOTE: All measurements are nominal. Elevation charts are not to scale.

Radius units are sash set as standard. Direct set units are available.

Glass sizes differ for direct set units. Contact your supplier for details.

The units shown are stand-alone units. Adjustments may be required when stacking over other units; adjustments will be made in the factory.

Divided lites are optional. Divided lite pattern options are shown on pg. 120.

Some installation procedures will require a larger rough opening than noted (i.e. installations utilizing our installation clips), therefore, you may need to increase the rough opening size accordingly. Rough opening gaps may be increased up to a maximum of 1/2" on all sides and still be within good practice guidelines. For rough opening recommendations, see pg. 196.

PRODUCT CODES:

To order, add "W" before the product number (Ex: WFC6-0).

U.D. = Unit Dimension • R.O. = Rough Opening • G.S. = Glass Size

Radius | Cross Section Drawings

Sash Set Units

Vertical Section

To Match Casements

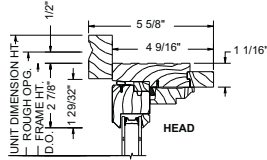

To Match Double Hungs & Doors (except outswing)

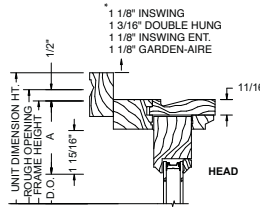

To Match Outswing Doors

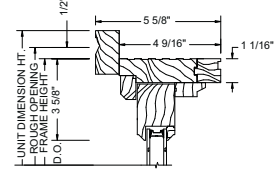

Horizontal Section

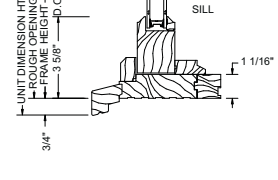
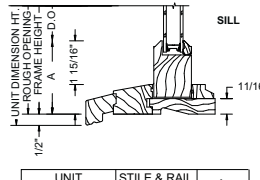
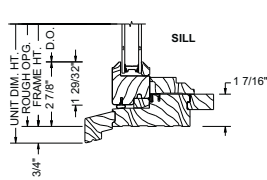
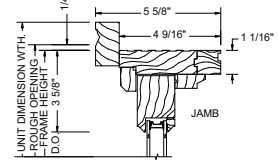
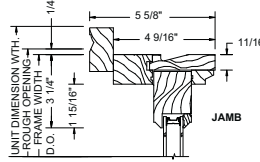
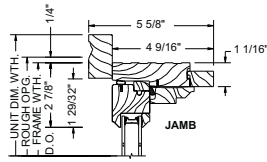

UNIT TYPE	STILE & RAIL SIZE	A
INSWING	2 1/2"	3 1/4"
DOUBLE HUNG	2 1/2"	3 1/4"
INSWING ENT.	2 1/2"	3 1/4"
GARDEN-AIRE	3 5/16"	4 1/16"

* The amount the brickmould extends beyond the frame varies depending on the unit the radius is stacked on.

Direct Set Units

Vertical Section

To Match Casements

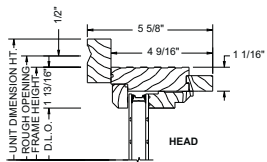

To Match Double Hungs & Doors (except outswing)

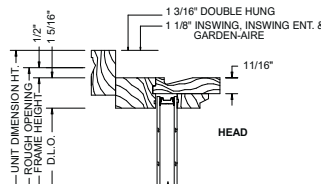

To Match Outswing Doors

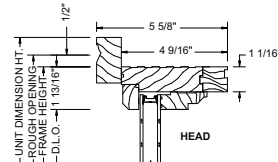

Horizontal Section

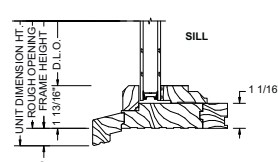
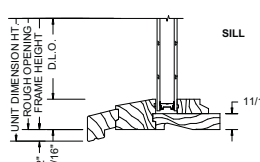
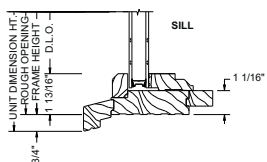
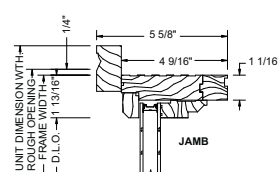
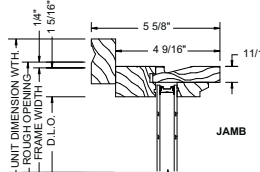
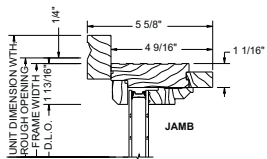

Radius Unit Stacking Details

Stacked over Casements

Sash Set

Direct Set

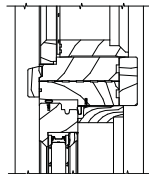
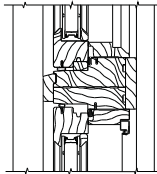

Stacked over Double Hungs

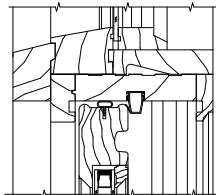
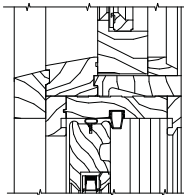

Stacked over Garden-Aire Siding Patio Doors

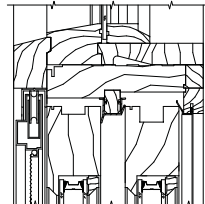
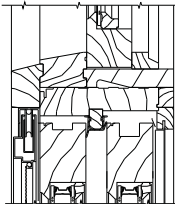

Stacked over Inswing Patio or Inswing Entrance Doors

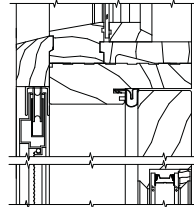
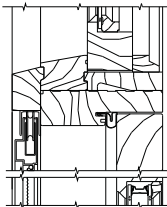

Stacked over Outswing Entrance Doors

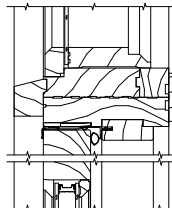
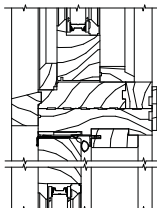

NOTE: Drawings are not to scale. Radius cross section drawings to complement Magnum double hungs can be obtained from Kolbe's website. Additional and the most current drawings are available in the Architect Library at www.kolbe-kolbe.com.





Patio Doors

Heritage Series patio doors add warmth and elegance to any project. Sliding patio doors are the perfect solution for an attractive and space-saving opening to a terrace or garden. Or, choose inswing or French patio doors to provide a convenient way to access a patio or even an adjoining room. To allow for additional light and a panoramic view, mull a series of patio doors together – or include matching transoms or radius units. Stylish hardware with finishes to match any decor will add beauty and originality to your passageway.

Garden-Aire Sliding Patio Doors | Inswing Patio Doors | Folding Doors



Garden-Aire Sliding Patio Doors



Sliding patio doors are a space-saving way to connect your indoor and outdoor living spaces. Slide the doors from side-to-side to operate and create access to the outdoors. Sliding patio doors are available in various sizes to accommodate new construction or remodeling projects.

Garden-Aire Sliding Patio Door Standard Features

- ▶ 1-3/4" thick sash
- ▶ Standard jamb width is 5"
- ▶ 3" wide LVL stiles and rails
- ▶ Frame setup
- ▶ Constructed of pine, with pine interior stops and wood mull casings on mullied units
- ▶ Energy efficient, insulating LoE²-270 glass
- ▶ Glazed to the interior with beveled wood glazing beads
- ▶ All wood interior for clean look
- ▶ 1-15/16" exterior brickmould applied
- ▶ All exterior wood parts are preservative-treated
- ▶ Exterior frame and panels are latex primed
- ▶ Fully weatherstripped for a tight seal
- ▶ Tandem rollers with adjustable, ball-bearing wheels carry the sliding panel
- ▶ Single-point mortise latch with handle set in a Bright Brass finish
- ▶ Screens with BetterVue[®] fiberglass mesh and extruded aluminum frames
- ▶ One-piece, pultruded fiberglass sill with continuous aluminum sill nosing and fiberglass sill filler
- ▶ Thick oak interior threshold

NOTE: All measurements are nominal.

Hardware

As standard, a single-point mortise latch is factory-applied to each Garden-Aire sliding patio door, with a Bright Brass handle set shipped loose for field installation. A multi-point lock and handle is also available. Handle sets and finish options are shown below.

	Bright Brass	Antique Brass	Satin Nickel	Antique Nickel	Rustic Umber	Matte Black	Oil-Rubbed*	Smoky Gray	
Standard Handle								N/A	 Optional "arch" escutcheon The arch escutcheon option for multi-point handle sets for sliding doors will complement Verona swinging door handle sets
Multi-point Handle									
	PVD†		PVD†	PVD†				PVD†	

*The Oil-Rubbed finish is a living finish, which means that it will change appearance over time with use.



Garden-Aire Sliding Patio Door Optional Features

Glass (pgs. 184-185): (all door glass is tempered)

- ▶ LoE-180
- ▶ LoE²-240
- ▶ LoE³-366
- ▶ ThermaPlus™ LoE
- ▶ Patterned, bronze- or gray-lite
- ▶ Laminated glass
- ▶ Other options standard to the industry

Divided Lites (pgs. 186-187):

- ▶ Performance divided lites with 5/8", 7/8", 1-1/8", 1-3/4", 2-1/4", or 4-1/2" bars
- ▶ True divided lites with 5/8" LoE² insulating glass and 1-1/8" bars
- ▶ Grilles-in-the-air-space
- ▶ Interior removable wood grilles with 7/8" or 1-1/8" bars and full surrounds

Exterior Finishes (pg. 189):

- ▶ Urethane primer
- ▶ K-Kron II exterior paint finish

Other Options: (custom options are also available)

- ▶ Available with wide stiles and rails (stiles and top rail are a nominal 4-5/8", bottom rail is 7-9/16" or 12 5/8")
- ▶ Other wood species and FSC-certified wood (pg. 188)

- ▶ Available as a 3-wide unit in an Active-Fixed-Active configuration
- ▶ Interior casing (pg. 190)
- ▶ Two types of escutcheon styles: bell (standard) and arch (optional on multi-point only)
- ▶ 3-1/2" flat or profiled brickmould, backband on 3-1/2" brickmould and other custom millwork (pg. 190)
- ▶ Ovolo or square profile glazing beads and interior divided lite bars (pg. 192)
- ▶ Handle set and mortise latch in Antique Brass, Satin Nickel, Antique Nickel, Rustic Umber, Matte Black, Oil-Rubbed* and Smoky Gray finishes
- ▶ Multi-point lock
- ▶ Keyed lock
- ▶ Secondary security lock
- ▶ Corrosion-resistant hardware
- ▶ "Ultra" sliding screen with fiberglass mesh and extruded aluminum screen frames
- ▶ Screens with UltraVue® fiberglass mesh or aluminum mesh
- ▶ Extension jambs in a wide variety of sizes (shipped loose for field application)
- ▶ Galvanized steel installation clips
- ▶ High performance and K-Force® impact performance modifications
- ▶ Universal design aluminum sill ramp kits

NOTE: All measurements are nominal.

*The Oil-Rubbed finish is a living finish, which means that it will change appearance over time with use.

Inswing Patio Doors



Swinging patio doors swing in or out to provide convenient access to the outdoors. Corresponding radius or transom units can allow even more light to illuminate your home. Mull together with additional patio doors to create custom-configured panoramic views.

Inswing Patio Door Standard Features

- ▶ 1-3/4" thick sash panel prehung in the 1-5/16" frame
 - ▶ Standard jamb width is 4-9/16"
 - ▶ LVL locking stiles; stiles and top rails are a nominal 4-5/8" wide; bottom rail is a nominal 7-9/16" high
 - ▶ Constructed of pine, with pine interior stops and wood mull casings on muller units
 - ▶ Energy efficient, insulating LoE²-270 glass
 - ▶ Glazed to the interior with beveled wood glazing beads
 - ▶ 1-15/16" exterior brickmould applied
 - ▶ All exterior wood parts are preservative-treated
 - ▶ Exterior frame is latex primed
- ▶ Fully weatherstripped for a tight seal
 - ▶ Toronto handle set in a Bright Brass finish
 - ▶ HLS 9000 stainless steel multi-point locking hardware on single door panels, French doors have a 3-point lock on the active panel and a 2-point lock on the less active panel
 - ▶ Adjustable, 4" x 3-5/8" hinges with 5/8" radius corners in a Gold-painted finish
 - ▶ "Ultra" sliding screens with BetterVue[®] fiberglass mesh and extruded aluminum frames
 - ▶ Bronze-anodized aluminum, self-draining exterior sill with an oak interior threshold

NOTE: All measurements are nominal.

1-15/16" brickmould applied as standard





Inswing Patio Door Optional Features

Glass (pgs. 184-185): (all door glass is tempered)

- ▶ LoE-180
- ▶ LoE²-240
- ▶ LoE³-366
- ▶ ThermaPlus™ LoE
- ▶ Patterned, bronze- or gray-lite
- ▶ Laminated glass
- ▶ Other options standard to the industry

Divided Lites (pgs. 186-187):

- ▶ Performance divided lites with 5/8", 7/8", 1-1/8", 1-3/4", 2-1/4", or 4-1/2" bars
- ▶ True divided lites with 5/8" LoE² insulating glass and 1-1/8" bars
- ▶ Grilles-in-the-air-space
- ▶ Interior removable wood grilles with 7/8" or 1-1/8" bars and full surrounds

Exterior Finishes (pg. 189):

- ▶ Urethane primer
- ▶ K-Kron II exterior paint finish

Other Options: (custom options are also available)

- ▶ 3" or 6" optional stiles
- ▶ Optional 12 5/8" bottom rail
- ▶ Other wood species and FSC-certified wood (pg. 188)
- ▶ Interior prefinishing (pg. 188)
- ▶ Interior casing (pg. 190)
- ▶ 3-1/2" flat or profiled brickmould, backband on 3-1/2" brickmould and other custom millwork (pg. 190)
- ▶ Ovolo and square profile glazing beads and interior divided lite bars (pg. 192)

NOTE: All measurements are nominal.

[†] Dallas handle set is only available in Bright Brass PVD, Satin Nickel PVD, Matte Black, and Smoky Gray PVD.

*The Oil-Rubbed finish is a living finish, which means that it will change appearance over time with use.

- ▶ Toronto, München, Verona and Dallas[†] handle set in Bright Brass PVD, Antique Brass, Satin Nickel PVD, Antique Nickel PVD, Oil-Rubbed*, Rustic Umber, Matte Black, or Smoky Gray PVD finishes (pg. 136)
- ▶ 2-point flush bolt lock on less active panel of French doors
- ▶ Single-point locking system
- ▶ Adjustable, 4" x 3-5/8" hinges with 5/8" radius corners in Bright Brass, Bright Brass PVD, Antique Brass, Brushed Chrome PVD, Satin Nickel, Satin Nickel PVD, Antique Nickel, Smoky Gray PVD, Oil-Rubbed*, Rustic Umber and Matte Black finishes (pg. 137)
- ▶ Non-adjustable, residential, 4" x 4" ball-bearing hinges with 1/4" radius corners in Bright Brass, Antique Brass, Satin Nickel, Antique Nickel, Stainless Steel, Oil-Rubbed*, and Matte Black finishes (pg. 137)
- ▶ Non-adjustable, commercial-grade, 4" x 4" ball-bearing hinges with square corners in Bright Brass, Antique Brass, Stainless Steel, Oil-Rubbed* Matte Black, and Satin Nickel finishes (pg. 137)
- ▶ Non-adjustable, commercial-grade, 4-1/2" x 4-1/2" hinges in Bright Brass, Oil-Rubbed*, and Stainless Steel finishes (pg. 137)
- ▶ Self-closing, swinging screen includes a spring-loaded lock, aluminum screen frame to match unit exterior and choice of BetterVue® or UltraVue® fiberglass mesh or aluminum mesh
- ▶ Clear Anodized weep sill
- ▶ Adjustable sills in Bronze or Clear Anodized
- ▶ Thermal and non-thermal ADA-compliant sills
- ▶ Factory-applied extension jambs in a variety of sizes
- ▶ Galvanized steel installation clips

Folding Doors



Breathe in the fresh air, add architectural interest and merge outdoor and indoor space by using folding doors. Choose from a variety of operating styles: doors that swing out, fold to one side, or split and fold to either side.

Folding Door Standard Features

- ▶ 1-3/4" thick sash
- ▶ 6-9/16" minimum jamb width
- ▶ Folding doors feature LVL locking stiles; stiles and top rails are a nominal 4-5/8" wide; bottom rail is a nominal 7-9/16" high
- ▶ Frame setup up to 177" wide x 106" tall; all others knocked down
- ▶ Constructed of pine with pine interior stops
- ▶ All exterior wood parts are preservative-treated
- ▶ Exterior frame is latex primed
- ▶ Energy efficient, insulating LoE²-270 glass *(tempered glass is standard on folding doors)*
- ▶ Glazed to the interior with beveled wood glazing beads
- ▶ Fully weatherstripped for a tight seal
- ▶ Bronze weep sill
- ▶ Grooved guide rollers with adjustable, ball-bearing wheels carry the folding panels
- ▶ Multi-point mortise latch with handle set in a Bright Brass finish
- ▶ Face-mounted flush bolt locking hardware on folding panels
- ▶ Thick oak interior threshold

NOTE: All measurements are nominal.

Minimum panel height is 72", minimum panel width is 23-3/4", maximum panel height is 120" and maximum panel width is 39-3/8".

Hardware

Lock Bolts for Folding Doors



Flush Bolt
As standard, folding doors have surface-mounted flush bolts factory-applied. Sizes available include 7-1/2", 17-23/32", 23-5/8" or 39". *(shown in Matte Black; also available in Bright Brass, Chrome and Satin Nickel)*



Concealed Shoot Bolt
Additionally, folding doors with concealed shoot bolts are available with an Uno or Aria handle set *(below)*.

Handles for Folding Doors with Concealed Shoot Bolts

Folding panels with concealed shoot bolts are available with handles in two styles, Uno and Aria. Uno handles are available in Dull (Brushed) Chrome *(shown)* and Matte Black. Aria handles are available in Bright Brass, Chrome, Dull (Brushed) Chrome *(shown)* and Matte Black.

Uno

Aria



Handles for Swinging Doors

Folding doors can have a swinging door for easy access. The swinging door features a Toronto handle set as standard; other optional handle styles include, München, Dallas and Verona. Swinging door hardware is available in numerous colors; see page 136 for handle style photos.



Folding Door Optional Features

Glass (pgs. 184-185): (all door glass is tempered)

- ▶ LoE-180
- ▶ LoE²-240
- ▶ LoE³-366
- ▶ ThermaPlus™ LoE
- ▶ Neat®
- ▶ Patterned, bronze- or gray-lite
- ▶ Laminated or tempered
- ▶ Other options standard to the industry

Divided Lites (pgs. 186-187):

- ▶ Performance divided lites with 5/8", 7/8", 1-1/8", 1-3/4", 2-1/4", or 4-1/2" bars
- ▶ True divided lites with 5/8" LoE² insulating glass and 1-1/8" bars
- ▶ Grilles-in-the-air-space
- ▶ Interior removable wood grilles with 7/8" or 1-1/8" bars and full surrounds

Exterior Finishes (pg. 189):

- ▶ Urethane primer
- ▶ K-Kron II exterior paint finish

Other Options: (custom options are also available)

- ▶ Stile and top rail options: 3"†† or 6"
- ▶ Bottom rail options: 4-5/8", 6" or 12-5/8"

†† When folding doors are ordered with 3" stiles and panel size is larger than 8', panel thickness must be 2-1/4".

NOTE: All measurements are nominal.

Hinge color options for folding doors include Bright Brass, Chrome, Satin Nickel and Matte Black.

Finger Pulls for Folding Doors

When panels are configured such that the final panel does not have a hinge handle to pull in the panel, a finger pull can be installed so that the panel can be pulled in and secured. Finger pulls are available in Bright Brass, Chrome, Satin Nickel (shown at right) and Matte Black.



- ▶ 2-1/4" thick panel
- ▶ Other wood species and FSC-certified wood (pg. 188)
- ▶ Interior prefinishing (pg. 188)
- ▶ Interior casing (pg. 190)
- ▶ Ovolo and square profile glazing beads and interior divided lite bars (pg. 192)
- ▶ Single-point hardware for access door
- ▶ Black pleated sliding screens available up to 177" wide x 102" tall (screen opening size; screen only available on units with the frame setup)
- ▶ Exterior brickmoulds and casing
- ▶ Toronto, Verona, Dallas or München handle set for access door (pg. 136)
- ▶ Concealed shootbolt locking hardware for folding panels
- ▶ Uno or Aria handle set for folding panels with concealed shoot bolts
- ▶ Recessed floor track sill (interior), weep or non-weep in Bronze Anodized finish
- ▶ Recessed weep sill, Bronze Anodized finish
- ▶ Weep sill, Clear Anodized finish
- ▶ Extension jambs in a wide variety of sizes (shipped loose for field application if over 12")
- ▶ Galvanized steel installation clips
- ▶ Magnetic latch available to assist in keeping doors stationary while open

Magnetic Latch for Folding Doors

When panels are in an open position, some movement can occur due to wind or other factors. When magnetic latches are attached to the panel, the panels remain stationary. The purpose of this latch is to prevent movement, thereby keeping the panels in a fully open position.



Swinging Patio Door Hardware



Photo courtesy of Group 3 Architecture & John McManus Photography

Hardware

To truly customize your patio door, numerous hardware options are available.

	Bright Brass PVD [†]	Antique Brass	Satin Nickel PVD [†]	Antique Nickel PVD [†]	Oil-Rubbed [*]	Rustic Umber	Matte Black	Smoky Gray PVD [†]
Toronto								
München								
Verona								
Dallas		N/A		N/A	N/A	N/A		

[†] PVD (Physical Vapor Deposition) finish is an application over the color which helps protect the hardware against tarnishing, peeling and cracking.

^{*} The Oil-Rubbed finish is a living finish, which means that it will change appearance over time with use.



Non-Adjustable Hinges

Residential, 4" x 4" ball-bearing, with 1/4" radius corners



Bright Brass



Antique Brass



Satin Nickel



Antique Nickel



Stainless Steel



Oil-Rubbed*



Matte Black

Adjustable Hinges



Gold-painted



Bright Brass



Bright Brass PVD†



Antique Brass



Brushed Chrome PVD†



Satin Nickel



Satin Nickel PVD†



Antique Nickel



Smoky Gray PVD†



Oil-Rubbed*



Rustic Umber



Matte Black

Non-Adjustable Hinges

Commercial-grade, 4" x 4" ball-bearing, with square corners



Bright Brass



Antique Brass



Stainless Steel



Oil-Rubbed*



Matte Black



Satin Nickel

Commercial-grade, 4-1/2" x 4-1/2"



Bright Brass



Oil-Rubbed*



Stainless Steel

†PVD (Physical Vapor Deposition) finish is an application over the color which helps protect the hardware against tarnishing, peeling and cracking.

*The Oil-Rubbed finish is a living finish, which means that it will change appearance over time with use.

Garden-Aire Patio Doors Elevation Charts

Garden-Aire Sliding Patio Doors

	2'-10 3/4"	3'-4 3/4"	3'-7 1/2"	4'-4 3/4"	5'-2 1/4"	6'-2 1/4"	6'-7 3/4"	8'-2 1/4"	7'-10 3/4"	9'-4 3/4"	10'-1"	12'-4 3/4"
U.D.	2'-9"	3'-3"	3'-5 3/4"	4'-3"	5'-0 1/2"	6'-0 1/2"	6'-6"	8'-0 1/2"	7'-9"	9'-3"	9'-11 1/4"	12'-3"
R.O.	25 1/4"	34 1/4"	34"	43 1/4"	25 1/4"	31 1/4"	34"	43 1/4"	25 1/4"	34 1/4"	34"	43 1/4"
G.S.	22"	28"	30 3/4"	40"	22"	28"	30 3/4"	40"	22"	28"	30 3/4"	40"
6'-11 9/16"												
6'-10 15/16"												
7'-3 9/16"												
7'-2 15/16"												
8'-3 9/16"												
8'-2 15/16"												
8'-2 15/16"												
84 7/16"												

3-Wide Garden-Aire Sliding Patio Doors

	9'-8 1/8"	11'-8 1/8"	15'-8 1/8"
U.D.	9' 6-3/8"	11'-6 3/8"	15'-6 3/8"
R.O.	25 1/4" 51 1/2" 25 1/4"	31 1/4" 63 1/2" 31 1/4"	43 1/4" 87 1/2" 43 1/4"
G.S.	22" 48 1/4" 22"	28" 60 1/4" 28"	40" 84 1/4" 40"
6'-11 9/16"			
6'-10 15/16"			
7'-3 9/16"			
7'-2 15/16"			
8'-3 9/16"			
8'-2 15/16"			
84 7/16"			

Operation is viewed from the exterior. Standard operation is shown. Please specify if other operational configurations are needed.

4-Wide Garden-Aire Sliding Patio Doors

	10'-0 9/16"	12'-0 9/16"	16'-0 9/16"
U.D.	9'-10 13/16"	11'-10 13/16"	15'-10 13/16"
R.O.	25 1/4"	31 1/4"	43-1/4"
G.S.	22"	28"	40"
6'-11 9/16"			
6'-10 15/16"			
7'-3 9/16"			
7'-2 15/16"			
8'-3 9/16"			
8'-2 15/16"			
84 7/16"			

NOTE: All measurements are nominal. Elevation charts are not to scale.

Divided lites are optional. The configuration shown for a single panel is typical for each panel.

Some installation procedures will require a larger rough opening than noted (i.e. installations utilizing our installation clips), therefore, you may need to increase the rough opening size accordingly. Rough opening gaps may be increased up to a maximum of 1/2" on all sides and still be within good practice guidelines. For rough opening recommendations, see pg. 196.

* Glass size for wide-stile Garden-Aire.

PRODUCT CODES:

To order, add "GAW" before the product number (Ex: GAW4-16080).

U.D. = Unit Dimension • R.O. = Rough Opening

G.S. = Glass Size (Glass sizes are shown per panel.)

Garden-Aire Sliding Patio Doors | Remodeling Sizes

U.D.	2'-10 1/4"	5'-1 1/4"	7'-9 1/4"	3'-4 1/4"	6'-1 1/4"	9'-3 1/4"	4'-4 1/4"	8'-1 1/4"	12'-3 1/4"
R.O.	2'-8 1/2"	4'-11 1/2"	7'-7 1/2"	3'-2 1/2"	5'-11 1/2"	9'-1 1/2"	4'-2 1/2"	7'-11 1/2"	12'-1 1/2"
G.S.	24 3/4"	24 3/4"	24 3/4"	30 3/4"	30 3/4"	30 3/4"	42 3/4"	43 3/4"	43 3/4"
G.S.*	21 1/2"	21 1/2"	21 1/2"	27 1/2"	27 1/2"	27 1/2"	39 1/2"	39 1/2"	39 1/2"

6'-9 1/16"									
6'-8 7/16"									
72 1/2"									
65 15/16"									
	2866	41166	7766	3266	51166	9166	4266	71166	12166

Garden-Aire | Rectangular Transoms

U.D.	2'-10 3/4"	3'-4 3/4"	3'-7 1/2"	4'-4 3/4"	5'-2 1/4"	6'-2 1/4"	6'-8 1/4"	8'-2 1/4"
R.O.	2'-9"	3'-3"	3'-5 3/4"	4'-3"	5'-0 1/2"	6'-0 1/2"	6'-6 1/2"	8'-0 1/2"
G.S.	25 1/4"	31 1/4"	34"	43 1/4"	52 3/4"	64 3/4"	70 3/4"	88 3/4"

1'-0 1/2"								
1'-0"								
1'-4"								
1'-5 1/2"								
1'-6"								
1'-7 1/2"								
1'-8"								
1'-9 1/2"								
1'-10 1/2"								
2'-0"								
2'-1 1/2"								
2'-1"								
2'-6"								
22 1/4"								

Operation is viewed from the exterior.

Standard operation is shown. Please specify if other operational configurations are needed.

NOTE: All measurements are nominal. Elevation charts are not to scale.

Rectangular transom units are sash set as standard. The units shown are stand-alone units. Adjustments may be required when stacking over other units; adjustments will be made in the factory.

Divided lites are optional. The configuration shown for a single panel is typical for each panel.

Some installation procedures will require a larger rough opening than noted (i.e. installations utilizing our installation clips), therefore, you may need to increase the rough opening size accordingly. Rough opening gaps may be increased up to a maximum of 1/2" on all sides and still be within good practice guidelines. For rough opening recommendations, see pg. 196.

* Glass size for wide stile Garden-Aire.

PRODUCT CODES:

To order remodeling sizes, add "GAW" before the product number (Ex: GAW12166). To order rectangular transoms, add "GAWT" before the product number (Ex: GAWT2910).

U.D. = Unit Dimension • R.O. = Rough Opening

G.S. = Glass Size (Glass sizes are shown per panel.)

Dimension Calculations

Elevation charts provide wood unit dimensions for units with the standard 1 15/16" brickmould. Below are the calculations to determine the frame size of units with brickmould.

	Width	Height
1-15/16" brickmould; U.D. to F.S.	-2 1/4"	-1 1/8"
3-1/2" flat or profiled casing; U.D. to F.S.	-5 3/8"	-2 11/16"
3-1/2" casing and backband; U.D. to F.S.	-6 7/8"	-3 7/16"

F.S. to Panel O.S.M.	+1/2" ÷ 2	-2 3/4"
Panel O.S.M. to G.S. (standard stiles & rails)	-5"	-4 11/16"
G.S. to D.L.O.	-1"	-1"

Note: Clear opening dimensions can be found on pg. 203. Contact supplier for 4-wide Garden-Aire dimension calculations.

F.S. = Frame Size • G.S. = Glass Size • O.S.M. = Outside Measurement
D.L.O. = Daylight Opening • U.D. = Unit Dimension

Garden-Aire Patio Doors Cross Section Drawings

Standard Garden-Aire

Vertical Section

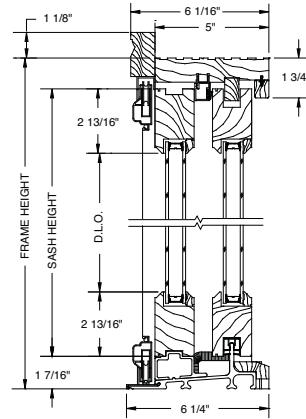

Horizontal Section

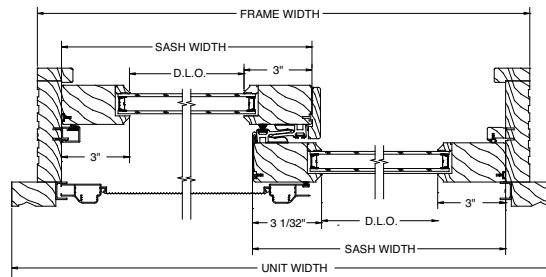

Garden-Aire with Sidelite

Horizontal Section

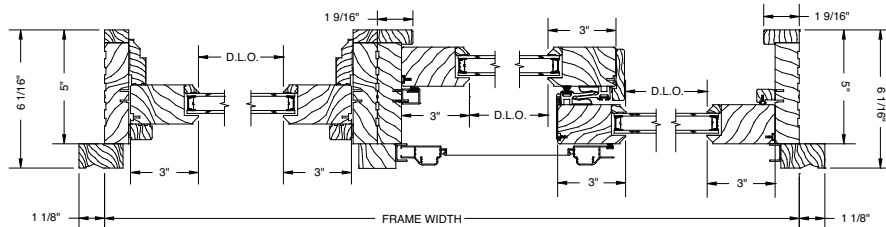

NOTE: Drawings are not to scale. Additional and the most current drawings are available in the Architect Library at www.kolbe-kolbe.com.

3-Wide Garden-Aire

Horizontal Section

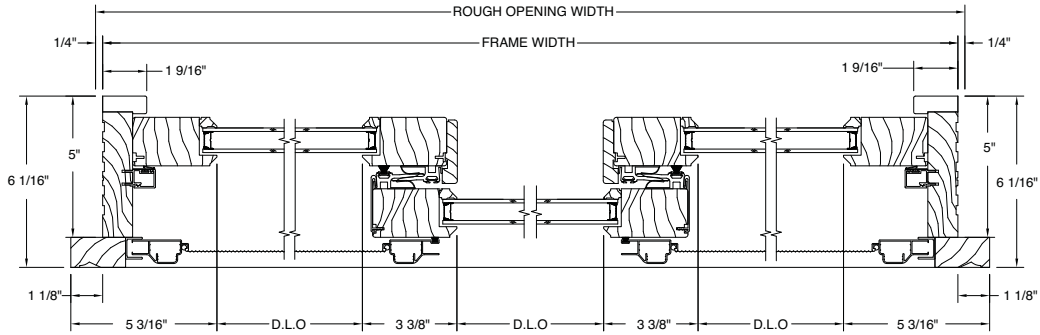

4-Wide Garden-Aire

Horizontal Section

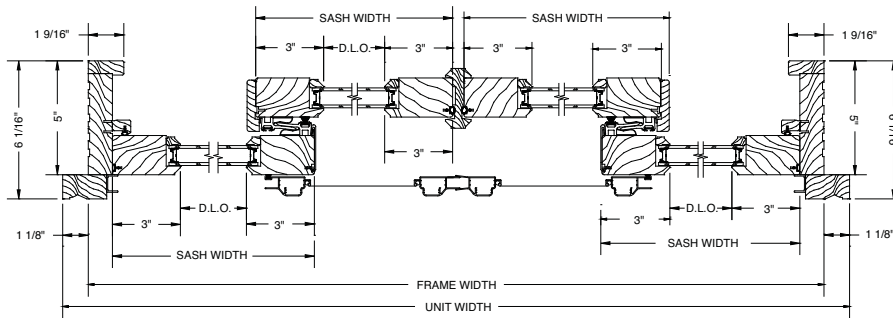

Rectangular Transom Stacked over Garden-Aire Doors

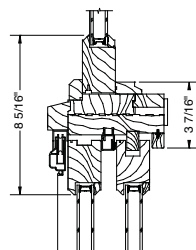

NOTE: Drawings are not to scale. Additional and the most current drawings are available in the Architect Library at www.kolbe-kolbe.com.

Garden-Aire Patio Doors Cross Section Drawings

Wide-Stile Garden-Aire Vertical Section

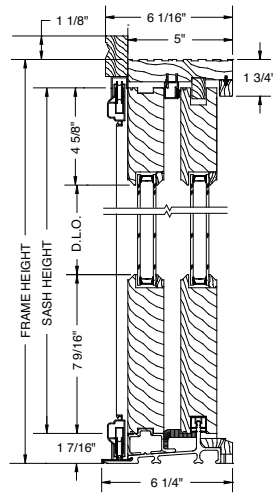

Horizontal Section

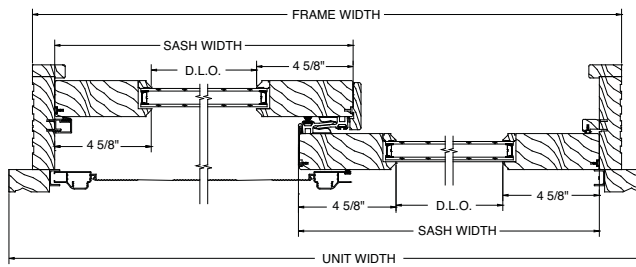

Garden-Aire with Sidelite

Horizontal Section

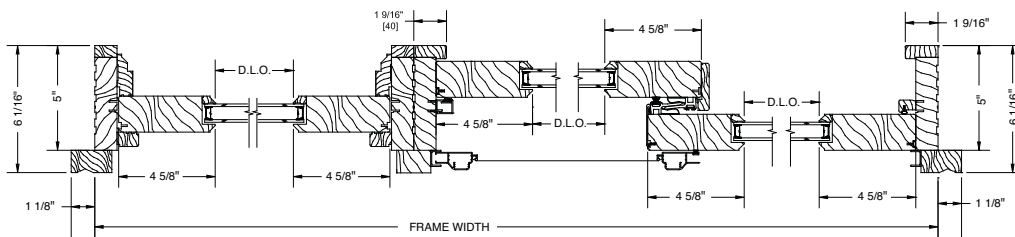

NOTE: Drawings are not to scale. Additional and the most current drawings are available in the Architect Library at www.kolbe-kolbe.com.

3-Wide Garden-Aire

Horizontal Section

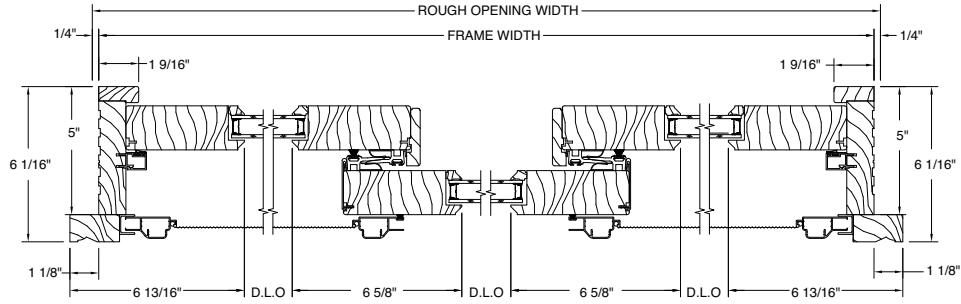

4-Wide Garden-Aire

Horizontal Section

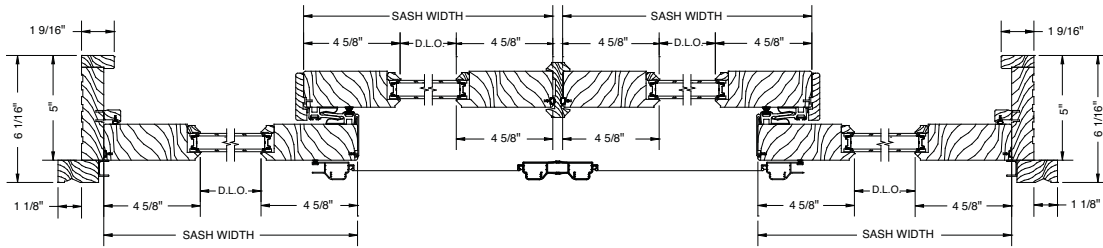

Rectangular Transom Stacked over Garden-Aire Doors

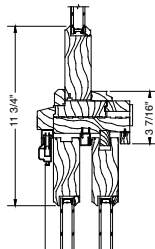

NOTE: Drawings are not to scale. Additional and the most current drawings are available in the Architect Library at www.kolbe-kolbe.com.

Inswing Patio Doors | Elevation Charts

Inswing Patio Doors

U.D.	2'-8 1/2"	5'-1 11/16"	5'-1 11/16"	7'-6 7/8"	7'-6 7/8"	3'-2 1/2"	6'-1 11/16"	6'-1 11/16"	9'-0 7/8"	9'-0 7/8"	
R.O.	2'-6 3/4"	4'-11 15/16"	4'-11 15/16"	7'-5 1/8"	7'-5 1/8"	3'-0 3/4"	5'-11 15/16"	5'-11 15/16"	8'-11 1/8"	8'-11 1/8"	
G.S.	20 5/16"	20 5/16"	20 5/16"	20 5/16"	20 5/16"	26 5/16"	26 5/16"	26 5/16"	26 5/16"	26 5/16"	
6'-8 5/8" 6'-8" 65 11/16"											
	2666	41166AS	41166SA	7566SASR	7566SASL	3066	51166AS	51166SA	81166SASR	81166SASL	
	8'-0 23/32" 8'-0 1/8" 81 29/32"										
		2680*	41180AS*	41180SA*	7580SASR*	7580SASL*	3080*	51180AS*	51180SA*	81180SASR*	81180SASL*

Operation is viewed from the interior.

Dimension Calculations

Elevation charts provide wood unit dimensions for units with the standard 1 15/16" brickmould. Below are the calculations to determine the frame size of units with brickmould.

	Width	Height
1-15/16" brickmould; U.D. to F.S.	-2 1/4"	-1 1/8"
3-1/2" flat or profiled casing; U.D. to F.S.	-5 3/8"	-2 11/16"
3-1/2" casing and backband; U.D. to F.S.	-6 7/8"	-3 7/16"

F.S. to Panel O.S.M. (1-wide, active)	-1 13/16"	-2 23/32"
(1-wide, stationary)	-1 3/4"	-2 23/32"
(2-wide)	-2 9/16" ÷ 2	-2 23/32"
(3-wide)	-3 5/16" ÷ 3	-2 23/32"

Panel O.S.M. to G.S.	-8 1/8"	-11 3/32"
G.S. to D.L.O.	-1"	-1"

Note: Clear opening dimensions can be found on pg. 204.

F.S. = Frame Size • G.S. = Glass Size • O.S.M. = Outside Measurement
D.L.O. = Daylight Opening • U.D. = Unit Dimension

NOTE: All measurements are nominal. Elevation charts are not to scale.

Divided lites are optional. The configuration shown for a single panel is typical for each panel in the unit.

Additional swinging door sizes are available in the Entrance Door section.

Some installation procedures will require a larger rough opening than noted (i.e. installations utilizing our installation clips), therefore, you may need to increase the rough opening size accordingly. Rough opening gaps may be increased up to a maximum of 1/2" on all sides and still be within good practice guidelines. For rough opening recommendations, see pg. 196.

PRODUCT CODES:

To order, add "SPW" before the product number (Ex: SPW81180SASL). When ordering single units, specify stationary, hinged left or hinged right. Operation is viewed from the interior.

U.D. = Unit Dimension • R.O. = Rough Opening • G.S. = Glass Size (Glass sizes are shown per panel.)

Inswing Patio Doors | French Doors

U.D.	5'-1 11/16"	5'-1 11/16"	6'-1 11/16"	6'-1 11/16"
R.O.	4'-11 15/16"	4'-11 15/16"	5'-11 15/16"	5'-11 15/16"
G.S.	20 5/16"	20 5/16"	26 5/16"	26 5/16"
6'-8 5/8"				
6'-8"	41166AL	41166AR	51166AL	51166AR
65 11/16"				
8'-0 23/32"				
8'-0 1/8"	41180AL	41180AR	51180AL	51180AR
81 25/32"				

Operation is viewed from the interior.

Inswing Patio Doors | Rectangular Transoms

U.D.	2'-8 1/2"	3'-2 1/2"	5'-1 11/16"	6'-1 11/16"
R.O.	2'-6 1/2"	3'-0 1/2"	4'-11 11/16"	5'-11 11/16"
G.S.	24 1/2"	30 1/2"	53 11/16"	65 11/16"
1'-1 1/4"				
1'-0"	2610	3010	41110	51110
1'-5 1/4"				
1'-4"	2614	3014	41114	51114
1'-7 1/4"				
1'-6"	2616	3016	41116	51116
1'-9 1/4"				
1'-8"	2618	3018	41118	51118
2'-1 1/4"				
2'-0"	2620	3020	41120	51120
2'-7 1/4"				
2'-6"	2626	3026	41126	51126
24"				

NOTE: All measurements are nominal. Elevation charts are not to scale.

Rectangular transom units are sash set as standard.

The units shown are stand-alone units. Adjustments may be required when stacking over other units; adjustments will be made in the factory.

Divided lite configurations must be specified when ordering.

Some installation procedures will require a larger rough opening than noted (i.e. installations utilizing our installation clips), therefore, you may need to increase the rough opening size accordingly. Rough opening gaps may be increased up to a maximum of 1/2" on all sides and still be within good practice guidelines. For rough opening recommendations, see pg. 196.

PRODUCT CODES:

To order, add "SPWT" before the product number (Ex: SPWT2610).

U.D. = Unit Dimension • R.O. = Rough Opening • G.S. = Glass Size

Inswing Patio Doors Cross Section Drawings

Standard Inswing Patio Door

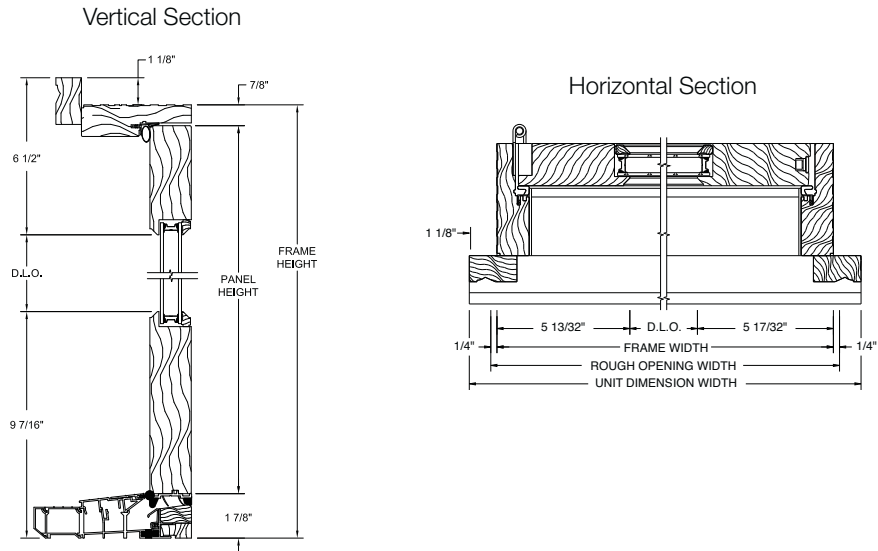

Rectangular Transom Stacked over Inswing Patio Door

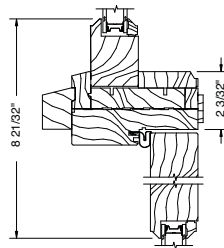

NOTE: Drawings are not to scale. Additional and the most current drawings are available in the Architect Library at www.kolbe-kolbe.com.

Two-Wide Inswing French Doors

Horizontal Section

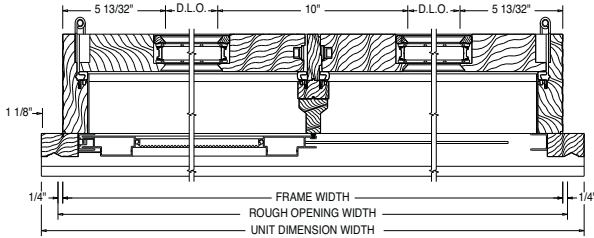

Two-Wide Inswing French Doors with Swinging Screen

Horizontal Section

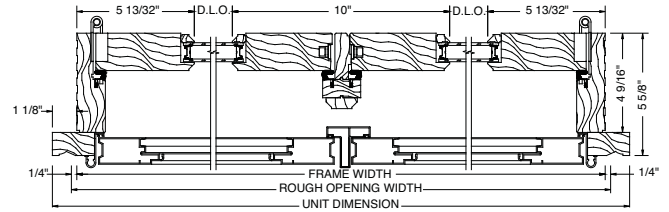

Two-Wide Inswing Doors - Stationary/Active

Horizontal Section

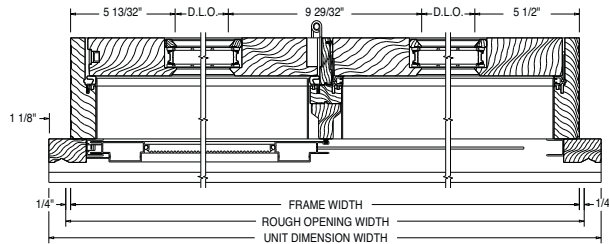

Three-Wide Inswing Doors

Horizontal Section

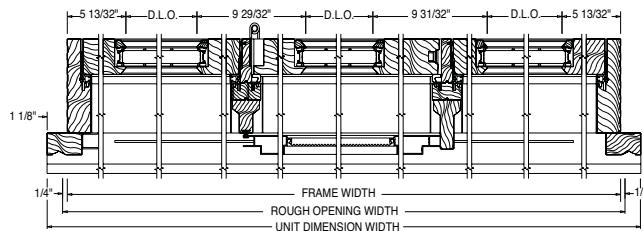

NOTE: Drawings are not to scale. Additional and the most current drawings are available in the Architect Library at www.kolbe-kolbe.com.

Folding Doors | Panel Configurations

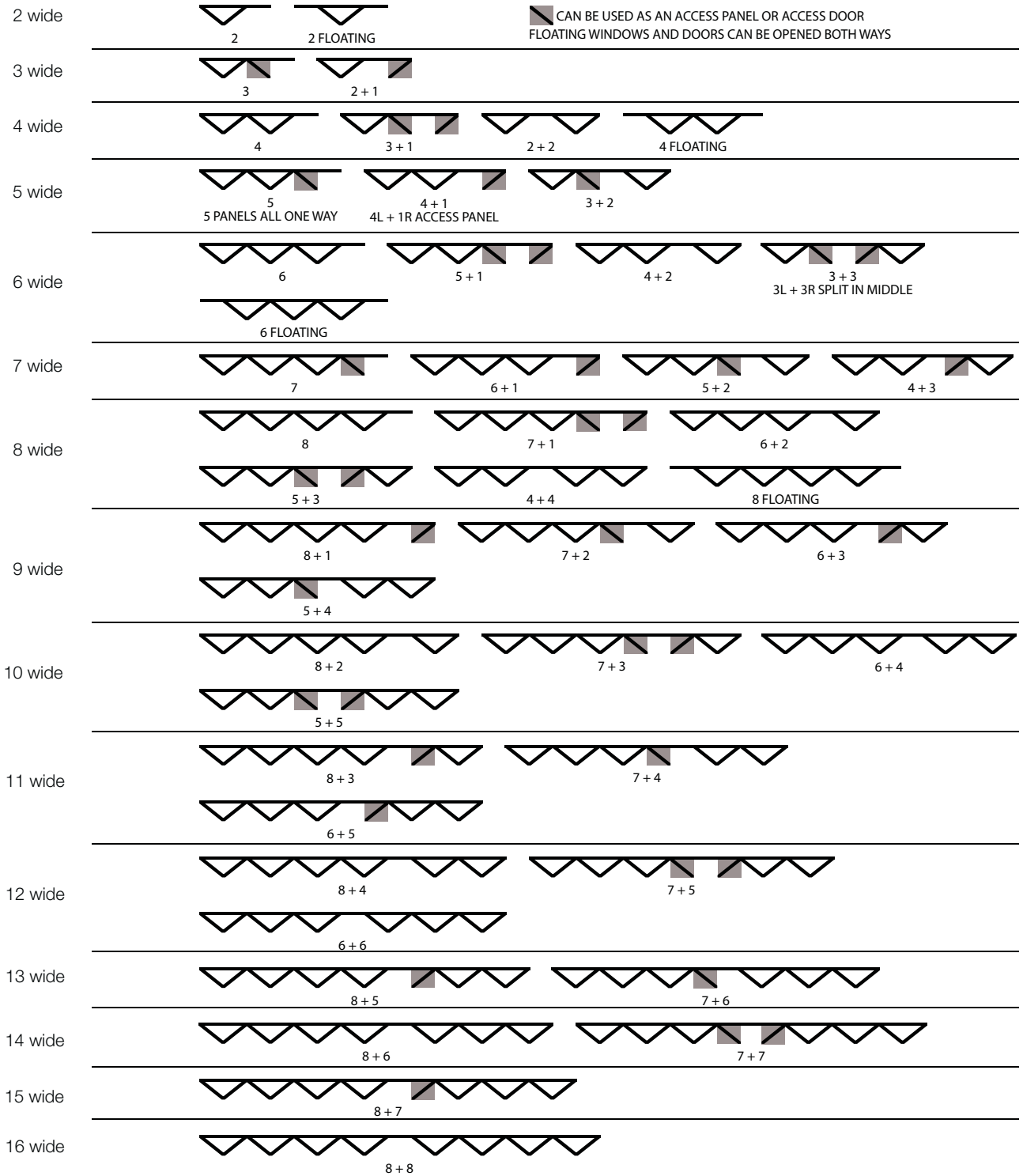

Folding Doors Cross Section Drawings

Four-Wide: Folding One-Way

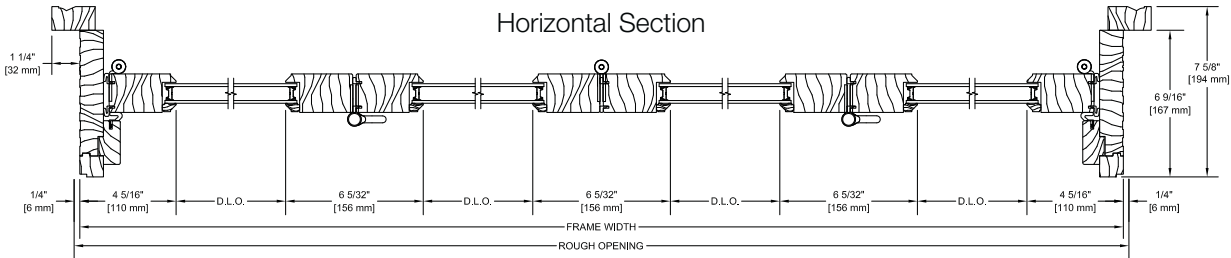

Four-Wide: One Left & Three Right

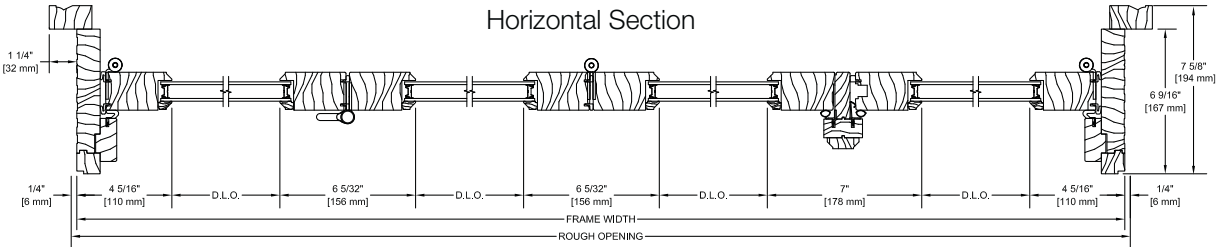

Four-Wide: Two Left & Two Right

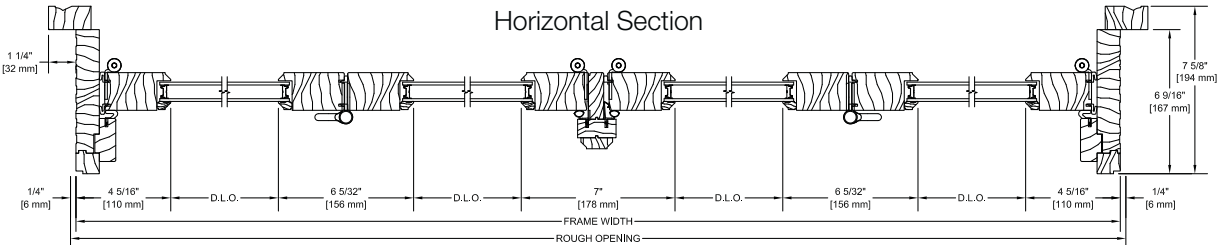

Operation is viewed from the exterior.

NOTE: Drawings are not to scale. Additional and the most current drawings are available in the Architect Library at www.kolbe-kolbe.com.

Folding Doors Cross Section Drawings

Corner Unit

Horizontal Section

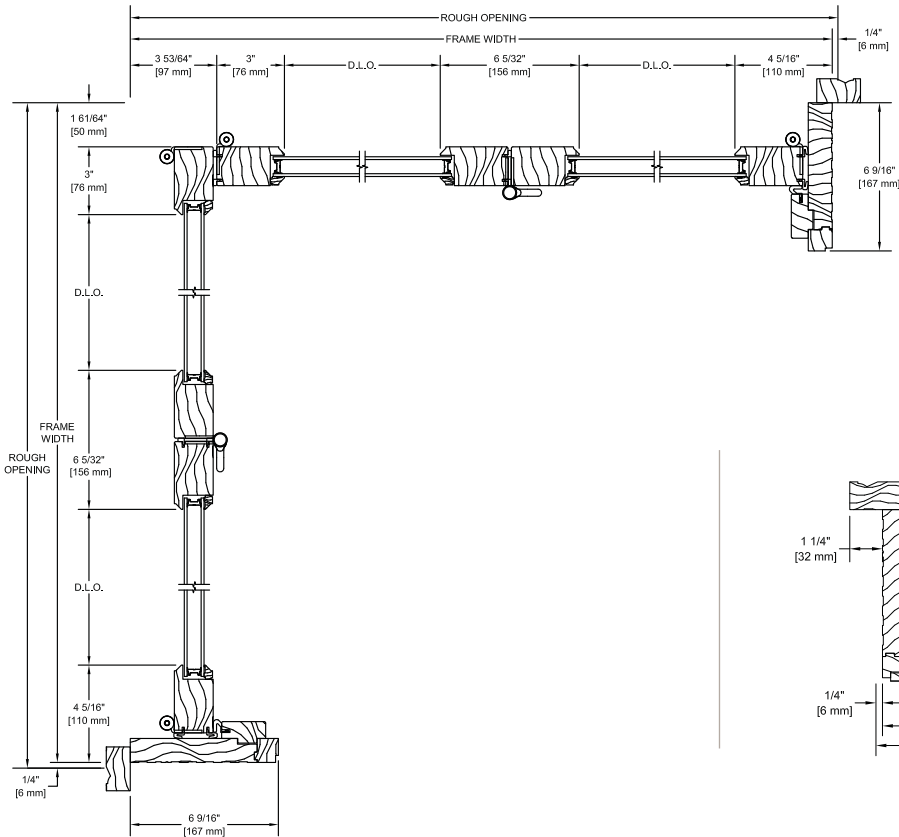

One Wide with Screen

Horizontal Section

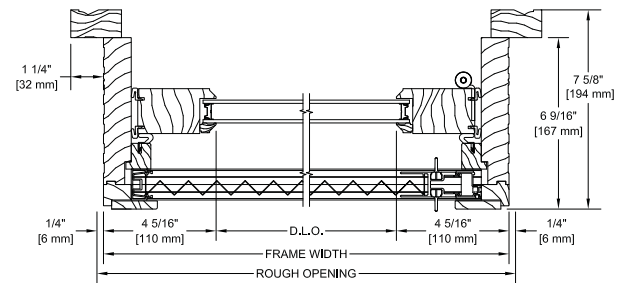

1.75 Panel with Recessed Sill

Vertical Section

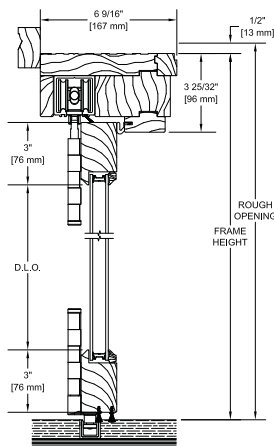

1.75 Panel with Weep Sill

Vertical Section

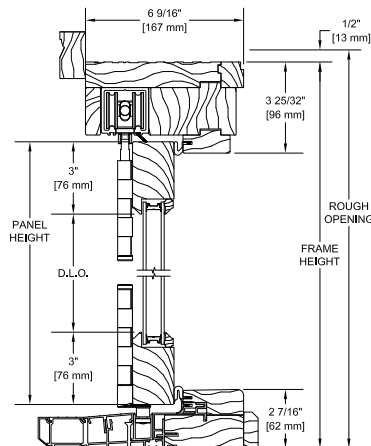

1.75 Panel with Weep Sill and Screen

Vertical Section

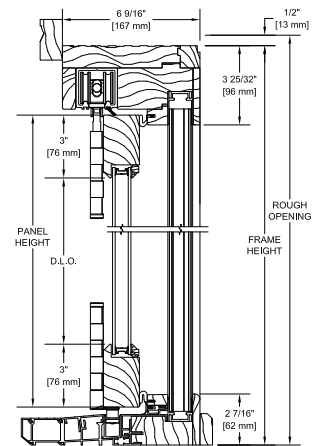

NOTE: Drawings are not to scale. Corner unit cross section will change when an odd number of panels are used. Additional and the most current drawings are available in the Architect Library at www.kolbe-kolbe.com.





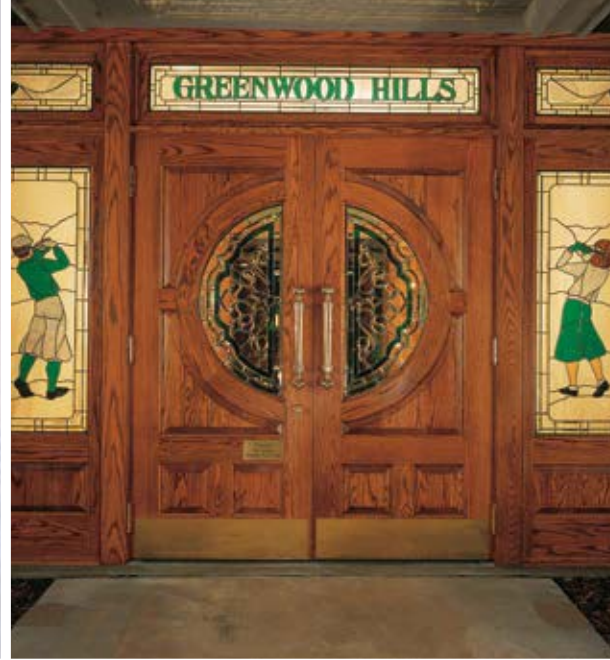

Entrance Doors

Create a dramatic focal point for your project with Heritage Series entrance doors. Choose an inswing or an outswing door, also available with French and raised panel options. To add a unique touch, decorate your entrance with Craftsman Collection doors. Combine with matching transoms and sidelites or select from a variety of special wood species and an array of glass and divided lite options to further enhance your design. Complete the appearance of your entryway by adding one of the attractive hardware options available in a variety of different finishes.

*Inswing Entrance Doors | Outswing Entrance Doors | Craftsman Collection Entrance Doors
Raised Panel Doors | Sidelites & Transoms*



Inswing Entrance Doors



Entrance doors are a defining feature of your home, which is why Kolbe offers a multitude of glass, panel configuration and wood species options to ensure that every entrance door creates a grand statement. Inswing entrance doors are available in single, double and French units, and can be customized with sidelites or transoms to create a distinctive entryway.

Inswing Entrance Door Standard Features

- ▶ 1-3/4" thick sash panel, prehung in the 3/4" frame with a 9/16" stop
- ▶ Standard jamb width is 4-9/16"
- ▶ LVL locking stiles; stiles and top rails are a nominal 4-5/8" wide; bottom rail is a nominal 7-9/16" high on all doors
- ▶ Constructed of pine, with pine interior stops and wood mull casings on mullied units
- ▶ Joints between stiles and rails are fastened with splined hardwood dowels
- ▶ Energy efficient, insulating LoE²-270 glass
- ▶ Glazed to the interior with beveled wood glazing beads
- ▶ 1-15/16" exterior brickmould applied
- ▶ All exterior wood parts are preservative-treated
- ▶ Exterior frame is latex primed
- ▶ Fully weatherstripped for a tight seal
- ▶ Adjustable, 4" x 3-5/8" hinges with 5/8" radius corners in a Gold-painted finish
- ▶ Bronze-anodized aluminum, self-draining exterior sill with an oak interior threshold

NOTE: All measurements are nominal.



1-15/16" brickmould applied as standard



Inswing Entrance Door Optional Features

Glass (pgs. 184-185): (all door glass is tempered)

- ▶ LoE-180
- ▶ LoE² -240
- ▶ LoE³ -366
- ▶ ThermaPlus™ LoE
- ▶ Patterned, bronze- or gray-lite
- ▶ Finely crafted glass in predetermined or custom patterns
- ▶ Laminated glass
- ▶ Other options standard to the industry

Divided Lites (pgs. 186-187):

- ▶ Performance divided lites with 5/8", 7/8", 1-1/8", 1-3/4", 2-1/4", or 4-1/2" bars
- ▶ True divided lites with 5/8" LoE² insulating glass and 1-1/8" bars
- ▶ Grilles-in-the-air-space
- ▶ Interior removable wood grilles with 1-1/8" bars and full surrounds

Exterior Finishes (pg. 189):

- ▶ Urethane primer
- ▶ K-Kron II exterior paint finish (not recommended for raised panel doors)

Other Options: (custom options are also available)

- ▶ 2-1/4" thick door panels
- ▶ Other wood species and FSC-certified wood (pg. 188)
- ▶ Interior prefinishing (pg. 188)
- ▶ Interior casing (pg. 190)
- ▶ 3-1/2" flat or profiled brickmould, backband on 3-1/2" brickmould and other custom millwork (pg. 190)
- ▶ Ovolo and square profile glazing beads and interior divided lite bars (pg. 192)
- ▶ High profile panel moulding
- ▶ 3" or 6" optional stiles and optional 12 5/8" bottom rail
- ▶ Toronto, München, Verona and Dallas[†] handle set in Bright Brass PVD, Antique Brass, Satin Nickel PVD, Antique Nickel PVD, Oil-Rubbed*, Rustic Umber, Matte Black, or Smoky Gray PVD finishes (pg. 160)

- ▶ HLS 9000 stainless steel multi-point locking hardware on single panel doors, French doors have a 3-point lock on the active panel and a 2-point lock on the less active panel
- ▶ 2-point flush bolt lock on less active panel of French doors
- ▶ Single-point locking system
- ▶ Adjustable, 4" x 3-5/8" hinges with 5/8" radius corners in Bright Brass, Bright Brass PVD, Antique Brass, Brushed Chrome PVD, Satin Nickel, Satin Nickel PVD, Antique Nickel, Smoky Gray PVD, Oil-Rubbed*, Rustic Umber and Matte Black finishes (pg. 161)
- ▶ Non-adjustable, residential, 4" x 4" ball-bearing hinges with 1/4" radius corners in Bright Brass, Antique Brass, Satin Nickel, Antique Nickel, Stainless Steel, Oil-Rubbed*, and Matte Black finishes (pg. 161)
- ▶ Non-adjustable, commercial-grade, 4" x 4" ball-bearing hinges with square corners in Bright Brass, Antique Brass, Stainless Steel, Oil-Rubbed* Matte Black, and Satin Nickel finishes (pg. 161)
- ▶ Non-adjustable, commercial-grade, 4-1/2" x 4-1/2" hinges in Bright Brass, Oil-Rubbed*, and Stainless Steel finishes (pg. 161)
- ▶ "Ultra" sliding screens with fiberglass or aluminum mesh and extruded aluminum frames
- ▶ Self-closing, swinging screen includes a spring-loaded lock, aluminum screen frame to match unit exterior and choice of BetterVue® or UltraVue® fiberglass mesh or aluminum mesh
- ▶ Extension jambs in a variety of sizes
- ▶ Clear Anodized weep sill
- ▶ Adjustable sills in Bronze or Clear Anodized
- ▶ Oak and Mahogany sills
- ▶ Thermal break or non-thermal break ADA-compliant sills
- ▶ Galvanized steel installation clips

NOTE: All measurements are nominal.

[†] Dallas handle set is only available in Bright Brass PVD, Satin Nickel PVD, Matte Black, and Smoky Gray PVD.

*The Oil-Rubbed finish is a living finish, which means that it will change appearance over time with use.

Outswing Entrance Doors



Outswing entrance doors are available with the same multitude of options as other entrance doors, but swing outward for areas that have space constraints. Outswing entrance doors are available in single, double and French units, and can be customized with sidelites or transoms to create a distinctive entryway.

Outswing Entrance Door Standard Features

- ▶ 1-3/4" thick sash panel, prehung in the 1-1/16" frame with a 1/2" rabbeted-in stop
- ▶ Standard jamb width is 4-9/16"
- ▶ LVL locking stiles; stiles and top rails are a nominal 4-5/8" wide; bottom rail is a nominal 7-9/16" high on all doors
- ▶ Constructed of pine, with pine interior stops and wood mull casings on mull units
- ▶ Joints between stiles and rails are fastened with splined hardwood dowels
- ▶ Energy efficient, insulating LoE²-270 glass
- ▶ Glazed to the interior with beveled wood glazing beads
- ▶ 1-15/16" exterior brickmould applied to wood units
- ▶ All exterior wood parts are preservative-treated
- ▶ Exterior frame is latex primed
- ▶ Fully weatherstripped for a tight seal
- ▶ Non-adjustable, residential, 4" x 4" ball-bearing hinges with 1/4" radius corners in a Bright Brass finish
- ▶ Bronze-anodized aluminum bumper sill with oak interior threshold

NOTE: All measurements are nominal.



1-15/16" brickmould applied as standard



Outswing Entrance Door Optional Features

Glass (pgs. 184-185): (all door glass is tempered)

- ▶ LoE-180
- ▶ LoE² -240
- ▶ LoE³ -366
- ▶ ThermaPlus™ LoE
- ▶ Patterned, bronze- or gray-lite
- ▶ Finely crafted glass in predetermined or custom patterns
- ▶ Laminated glass
- ▶ Other options standard to the industry

Divided Lites (pgs. 186-187):

- ▶ Performance divided lites with 5/8", 7/8", 1-1/8", 1-3/4", 2-1/4", or 4-1/2" bars
- ▶ True divided lites with 5/8" LoE² insulating glass and 1-1/8" bars
- ▶ Grilles-in-the-air-space
- ▶ Interior removable wood grilles with 1-1/8" bars and full surrounds

Exterior Finishes (pg. 189):

- ▶ Urethane primer
- ▶ K-Kron II exterior paint finish (not recommended for raised panel doors)

Other Options: (custom options are also available)

- ▶ 3" or 6" optional stiles and optional 12 5/8" bottom rail
- ▶ 2-1/4" thick door panels
- ▶ Other wood species and FSC-certified wood (pg. 188)
- ▶ Interior prefinishing (pg. 188)
- ▶ Interior casing (pg. 190)
- ▶ 3-1/2" flat or profiled brickmould, backband on 3-1/2" brickmould and other custom millwork (pg. 190)
- ▶ Ovolo and square profile glazing beads and interior divided lite bars (pg. 192)
- ▶ High profile panel moulding

- ▶ Toronto, München, Verona and Dallas[†] handle set in Bright Brass PVD, Antique Brass, Satin Nickel PVD, Antique Nickel PVD, Oil-Rubbed*, Rustic Umber, Matte Black, or Smoky Gray PVD finishes (pg. 160)
- ▶ HLS 9000 stainless steel multi-point locking hardware on single panel doors, French doors have a 3-point lock on the active panel and a 2-point lock on the less active panel
- ▶ 2-point flush bolt lock on less active panel of French doors
- ▶ Single-point locking system
- ▶ Non-adjustable, residential, 4" x 4" ball-bearing hinges with 1/4" radius corners in Antique Brass, Satin Nickel, Antique Nickel, Stainless Steel, Oil-Rubbed*, and Matte Black finishes (pg. 161)
- ▶ Adjustable, 4" x 3-5/8" hinges with 5/8" radius corners in Gold Painted, Bright Brass, Bright Brass PVD, Antique Brass, Brushed Chrome PVD, Satin Nickel, Satin Nickel PVD, Antique Nickel, Smoky Gray PVD, Oil-Rubbed*, Rustic Umber and Matte Black finishes (pg. 161)
- ▶ Non-adjustable, commercial-grade, 4" x 4" ball-bearing hinges with square corners in Bright Brass, Antique Brass, Stainless Steel, Oil-Rubbed* Matte Black, and Satin Nickel finishes (pg. 161)
- ▶ Non-adjustable, commercial-grade, 4-1/2" x 4-1/2" hinges in Bright Brass, Oil-Rubbed*, and Stainless Steel finishes (pg. 161)
- ▶ Extension jambs (up to 12" applied; over 12" shipped loose for field application)
- ▶ Clear Anodized bumper sill
- ▶ Oak bumper sills
- ▶ Oak and Mahogany sills
- ▶ Thermal break or non-thermal break ADA-compliant sills
- ▶ Galvanized steel installation clips
- ▶ High performance or K-Force® impact performance modifications for units with or without glass

NOTE: All measurements are nominal.

[†]Dallas handle set is only available in Bright Brass PVD, Satin Nickel PVD, Matte Black, and Smoky Gray PVD.

*The Oil-Rubbed finish is a living finish, which means that it will change appearance over time with use.

Craftsman Collection Doors



Wood panel Craftsman style entrance doors are the perfect match for Arts & Crafts style homes. Constructed of Vertical Grain Douglas Fir, Knotty Alder, or a custom wood species, these doors add classic warmth to any entryway.

Craftsman Door Standard Features

- ▶ 1-3/4" thick door panel
- ▶ Panel is constructed of unfinished vertical grain Douglas Fir
- ▶ Exterior frame is latex primed
- ▶ 5-1/2" wide stiles, 4-1/2" wide top rails, 7-1/2" wide cross rails, and a 7-9/16" bottom rail on all door heights
- ▶ Joints between stiles and rails are fastened with splined hardwood dowels
- ▶ Energy efficient, insulating LoE²-270 glass
- ▶ Glazed to the interior with wood glazing beads
- ▶ All exterior wood parts are preservative-treated
- ▶ Exterior frame is latex primed
- ▶ Ovolo sticking
- ▶ Inswing and outswing operation available

NOTE: All measurements are nominal.

Craftsman door panels may be prehung as inswing or outswing units.



Ovolo Sticking
*(standard, shown on
a raised panel)*



Square Sticking
*(optional, shown on
a flat panel)*



Craftsman Door Optional Features

Glass (pgs. 184-185): (all door glass is tempered)

- ▶ LoE-180
- ▶ LoE² -240
- ▶ LoE³ -366
- ▶ ThermaPlus LoE
- ▶ Patterned, bronze- or gray-lite
- ▶ Finely crafted glass
- ▶ Laminated glass
- ▶ Other options standard to the industry

Divided Lites (pgs. 186-187):

- ▶ Performance divided lites with 1-1/8" bars; wood both interior and exterior

Exterior Finishes (pg. 189): (frames only)

- ▶ Urethane primer
- ▶ K-Kron II exterior paint finish

Other Options: (custom options are also available)

- ▶ Other wood species and FSC-certified wood (pg. 188)
- ▶ Square sticking
- ▶ Interior clear coat or stain (pg. 188)
- ▶ Wire brushing for distressed appearance
- ▶ Mantel detailing
- ▶ Interior casing (pg. 190)
- ▶ 3-1/2" flat or profiled wood brickmould, backband on 3-1/2" brickmould and other custom millwork (pg. 190)
- ▶ Toronto, München, Verona and Dallas[†] handle set in Bright Brass PVD, Antique Brass, Satin Nickel PVD, Antique Nickel PVD, Oil-Rubbed*, Rustic Umber, Matte Black, or Smoky Gray PVD finishes (pg. 160)

NOTE: All measurements are nominal.

[†] Dallas handle set is only available in Bright Brass PVD, Satin Nickel PVD, Matte Black, and Smoky Gray PVD.

*The Oil-Rubbed finish is a living finish, which means that it will change appearance over time with use.

- ▶ HLS 9000 stainless steel multi-point locking hardware on single doors; 3-point lock on the active door and a 2-point lock on the less active door of French doors
- ▶ 2-point flush bolt lock on the less active door of French doors
- ▶ Single-point locking system
- ▶ Non-adjustable, residential, 4" x 4" ball-bearing hinges with 1/4" radius corners in Bright Brass, Antique Brass, Satin Nickel, Antique Nickel, Stainless Steel, Oil-Rubbed*, and Matte Black finishes (pg. 161)
- ▶ Adjustable, 4" x 3-5/8" hinges with 5/8" radius corners in Gold Painted, Bright Brass, Bright Brass PVD, Antique Brass, Brushed Chrome PVD, Satin Nickel, Satin Nickel PVD, Antique Nickel, Smoky Gray PVD, Oil-Rubbed*, Rustic Umber and Matte Black finishes (pg. 161)
- ▶ Non-adjustable, commercial-grade, 4" x 4" ball-bearing hinges with square corners in Bright Brass, Antique Brass, Stainless Steel, Oil-Rubbed* Matte Black, and Satin Nickel finishes (pg. 161)
- ▶ Non-adjustable, commercial-grade, 4-1/2" x 4-1/2" hinges in Bright Brass, Oil-Rubbed*, and Stainless Steel finishes (pg. 161)
- ▶ Extension jambs in a variety of sizes
- ▶ Oak bumper sills for outswing doors
- ▶ Oak and Mahogany sills
- ▶ Bronze or Clear Anodized weep sills for inswing doors
- ▶ Galvanized steel installation clips

Entrance Door Options



Hardware

As standard, inswing entrance and Craftsman inswing doors feature Gold-painted adjustable hinges. Outswing entrance and Craftsman outswing doors feature Bright Brass 4" x 4" non-adjustable hinges with 1/4" radius corners. Handle sets, boring or locking systems are not standard on entrance doors. The following hinges and handles are available as an option.

	Bright Brass PVD†	Antique Brass	Satin Nickel PVD†	Antique Nickel PVD†	Oil-Rubbed*	Rustic Umber	Matte Black	Smoky Gray PVD†
Toronto								
München								
Verona								
Dallas		N/A		N/A	N/A	N/A		

†PVD (Physical Vapor Deposition) finish is an application over the color which helps protect the hardware against tarnishing, peeling and cracking.

*The Oil-Rubbed finish is a living finish, which means that it will change appearance over time with use.



Non-Adjustable Hinges

Residential, 4" x 4" ball-bearing, with 1/4" radius corners



Bright Brass



Antique Brass



Satin Nickel



Antique Nickel



Stainless Steel



Oil-Rubbed*



Matte Black

Adjustable Hinges



Gold-painted



Bright Brass



Bright Brass PVD†



Antique Brass



Brushed Chrome PVD†



Satin Nickel



Satin Nickel PVD†



Antique Nickel



Smoky Gray PVD†



Oil-Rubbed*



Rustic Umber



Matte Black

Non-Adjustable Hinges

Commercial-grade, 4" x 4" ball-bearing, with square corners



Bright Brass



Antique Brass



Stainless Steel



Oil-Rubbed*



Matte Black



Satin Nickel

Commercial-grade, 4-1/2" x 4-1/2"



Bright Brass



Oil-Rubbed*







Stainless Steel

†PVD (Physical Vapor Deposition) finish is an application over the color which helps protect the hardware against tarnishing, peeling and cracking.
*The Oil-Rubbed finish is a living finish, which means that it will change appearance over time with use.

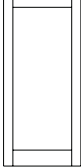
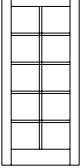
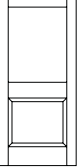
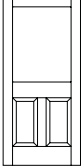
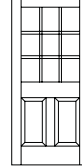
Inswing Entrance Doors Panel Designs

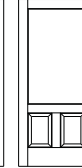
Inswing Entrance Door Panel Designs

										
Sash Design#:	KK610	KK625	KK6110	KK6210	KK6233	KK108-6	KK6110-30	KK6210-30	KK6110-24	KK6210-24
	Full Lite	2W5H Pattern	1 Lite over 1 Panel, 8" Cross Rail at 40"	1 Lite over 2 Panels, 8" Cross Rail at 40"	1 Lite over 2 Panels, 8" Cross Rail at 40" with 3W3H Pattern	6 Panels	1 Lite over 1 Panel, 4-5/8" Cross Rail at 30"	1 Lite over 2 Panels, 4-5/8" Cross Rail at 30"	1 Lite over 1 Panel, 4-5/8" Cross Rail at 24"	1 Lite over 2 Panels, 4-5/8" Cross Rail at 24"

NOTE: Sash design KK625 has TDL or PDL in the configuration shown. If a different configuration pattern is needed, specify sash design KK610 or KK6210 and the type of divided lite configuration desired.

Not all panel designs are available in all sizes.

Not all panel designs are shown; see your local Kolbe distributor for further assistance.

Dimension Calculations

Elevation charts provide wood unit dimensions for units with the standard 1 15/16" brickmould. Below are the calculations to determine the frame size of units with brickmould.

	Width	Height
1-15/16" brickmould; U.D. to F.S.	-2 1/4"	-1 1/8"
3-1/2" flat or profiled casing; U.D. to F.S.	-5 3/8"	-2 11/16"
3-1/2" casing and backband; U.D. to F.S.	-6 7/8"	-3 7/16"











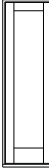

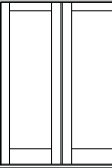

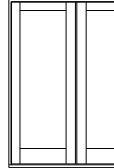

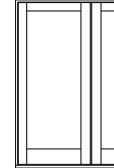
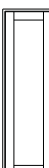

F.S. to Panel O.S.M. (1-wide, active)	-1 13/16"	-2 23/32"
(1-wide, stationary)	-1 3/4"	-2 23/32"
(2-wide)	-2 9/16" ÷ 2	-2 23/32"
(3-wide)	-3 5/16" ÷ 3	-2 23/32"
Panel O.S.M. to G.S. (wood 6-8 ht.)	-8 1/8"	-11 3/32"
G.S. to D.L.O.	-1"	-1"

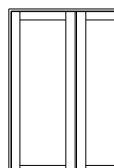
Note: Dimension calculations for sidelites and transoms may be obtained from your Kolbe dealer.
Clear opening dimensions can be found on pg. 196.

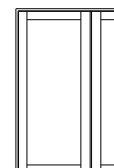
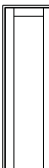
F.S. = Frame Size • G.S. = Glass Size • O.S.M. = Outside Measurement
D.L.O. = Daylight Opening • U.D. = Unit Dimension

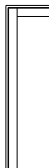
Outswing Entrance Doors Elevation Charts

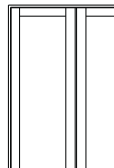
Inswing Entrance Doors

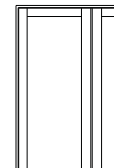
U.D.	2'-3 7/8"	4'-4 7/16"	2'-9 7/8"	5'-4 7/16"	2'-11 7/8"	5'-8 7/16"	3'-3 7/8"	6'-4 7/16"
R.O.	2'-2 1/8"	4'-2 11/16"	2'-8 1/8"	5'-2 11/16"	2'-10 1/8"	5'-6 11/16"	3'-2 1/8"	6'-2 11/16"
G.S.*	15 11/16"	15 11/16"	21 11/16"	21 11/16"	23 11/16"	23 11/16"	27 11/16"	27 11/16"
6'-11 27/32" 68 29/32"								
7'-3 27/32" 72 29/32"								
8'-3 27/32" 84 29/32"								

NOTE: All measurements are nominal. Elevation charts are not to scale.

Some installation procedures will require a larger rough opening than noted (i.e. installations utilizing our installation clips), therefore, you may need to increase the rough opening size accordingly. Rough opening gaps may be increased up to a maximum of 1/2" on all sides and still be within good practice guidelines. For rough opening recommendations, see pg. 196.

* Glass size widths are shown per panel for one-lite glass. For TDL glass sizes contact your supplier.

PRODUCT CODES:

To order, add "WXD" before the product number (Ex: WXD2068). Specify inswing. When ordering single units, specify stationary, hinged left or hinged right. Operation is viewed from the interior.

U.D. = Unit Dimension • R.O. = Rough Opening • G.S. = Glass Size

Inswing Entrance Doors Elevation Charts

Segment Head Inswing Entrance Doors

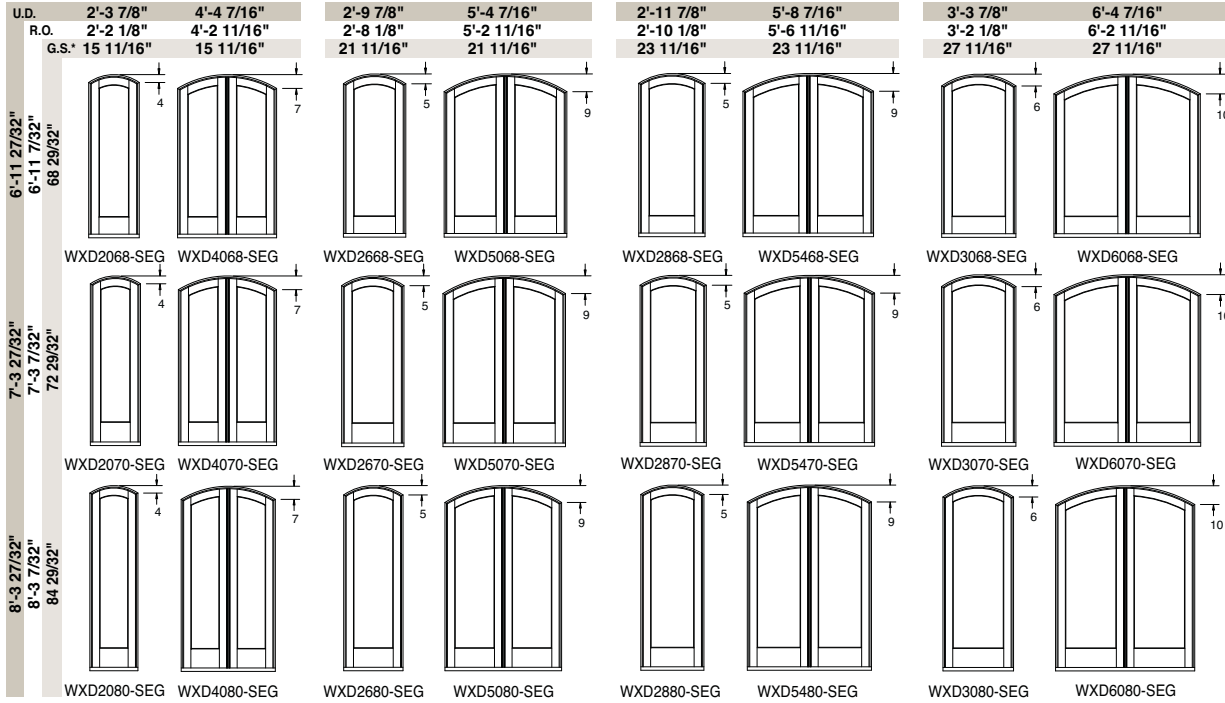

NOTE: All measurements are nominal. Elevation charts are not to scale.

Some installation procedures will require a larger rough opening than noted (i.e. installations utilizing our installation clips), therefore, you may need to increase the rough opening size accordingly. Rough opening gaps may be increased up to a maximum of 1/2" on all sides and still be within good practice guidelines. For rough opening recommendations, see pg. 196.

* Approximate glass sizes are given; true glass sizes may vary depending on the radius involved.

PRODUCT CODES:

To order use the product shown and specify inswing. When ordering single units, specify stationary, hinged left or hinged right. Operation is viewed from the interior.

U.D. = Unit Dimension • R.O. = Rough Opening • G.S. = Glass Size

Inswing Entrance Door Sidelites

U.D.	1'-4"	1'-6"	1'-8"	1'-10"
R.O.	1'-2 1/4"	1'-4 1/4"	1'-6 1/4"	1'-8 1/4"
G.S.*	7 3/4"	9 3/4"	11 3/4"	13 3/4"
6'-11 27/32"				
6'-11 7/32"				
68 29/32"				
7'-3 27/32"				
7'-3 7/32"				
68 29/32"				
8'-3 27/32"				
8'-3 7/32"				
84 29/32"				

Inswing Entrance Door Sidelite Panel Designs

Sash Design#:	KK510	KK515	KK5110	KK5110-30	KK5110-24
Full Lite	Full Lite	1W5H Pattern	1 Lite over 1 Panel, 8" Cross Rail at 40"	1 Lite over 1 Panel, 4-5/8" Cross Rail at 30"	1 Lite over 1 Panel, 4-5/8" Cross Rail at 24"

NOTE: All measurements are nominal. Elevation charts are not to scale.

Some installation procedures will require a larger rough opening than noted (i.e. installations utilizing our installation clips), therefore, you may need to increase the rough opening size accordingly. Rough opening gaps may be increased up to a maximum of 1/2" on all sides and still be within good practice guidelines. For rough opening recommendations, see pg. 196.

* Glass size widths are shown for one-lite glass. For TDL glass sizes, contact your Kolbe window and door supplier.

PRODUCT CODES:

To order, use the product code shown and specify wood profile.

Sidelite sash design KK515 has TDL or PDL in the configuration shown. If a different configuration pattern is needed, specify sash design KK510 or KK5110 and the type of configuration desired.

Not all panel designs are available in all sizes.

Not all panel designs are shown; see your local Kolbe distributor for further assistance.

U.D. = Unit Dimension • R.O. = Rough Opening • G.S. = Glass Size

Inswing Entrance Doors Elevation Charts

Inswing Entrance Doors | Rectangular Transoms

	2'-3 7/8"	2'-9 7/8"	2'-11 7/8"	3'-3 7/8"	4'-4 7/16"	5'-4 7/16"	5'-8 7/16"	6'-4 7/16"
U.D.	2'-3 7/8"	2'-9 7/8"	2'-11 7/8"	3'-3 7/8"	4'-4 7/16"	5'-4 7/16"	5'-8 7/16"	6'-4 7/16"
R.O.	2'-1 7/8"	2'-7 7/8"	2'-9 7/8"	3'-1 7/8"	4'-2 7/16"	5'-2 7/16"	5'-6 7/16"	6'-2 7/16"
G.S.	19 7/8"	25 7/8"	27 7/8"	31 7/8"	44 7/16"	56 7/16"	60 7/16"	68 7/16"
1'-1 3/8"								
1'-0"	2010	2610	2810	3010	4010	5010	5410	6010
1'-4"								
1'-10"	2014	2614	2814	3014	4014	5014	5414	6014
1'-6"								
1'-12"	2016	2616	2816	3016	4016	5016	5416	6016
1'-8"								
1'-4"	2018	2618	2818	3018	4018	5018	5418	6018
2'-0"								
1'-18"	2020	2620	2820	3020	4020	5020	5420	6020
2'-7 3/8"								
2'-6"	2026	2626	2826	3026	4026	5026	5426	6026

NOTE: All measurements are nominal.

Rectangular transom units are sash set as standard.

The units shown are stand-alone units. Adjustments may be required when stacking over other units; adjustments will be made in the factory.

Divided lite configurations must be specified when ordering. Specify inswing when ordering.

Some installation procedures will require a larger rough opening than noted (i.e. installations utilizing our installation clips), therefore, you may need to increase the rough opening size accordingly. Rough opening gaps may be increased up to a maximum of 1/2" on all sides and still be within good practice guidelines. For rough opening recommendations, see pg. 196.

PRODUCT CODES:

To order, add "WXDT" before the product number (Ex: WXDT6026).

U.D. = Unit Dimension • R.O. = Rough Opening • G.S. = Glass Size

Inswing Entrance Doors Cross Section Drawings

Hinging For Inswing Entrance Doors

HL (Hinged Left)

HR (Hinged Right)

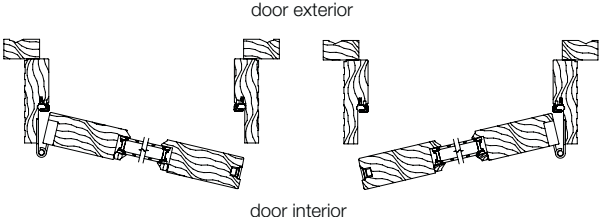

SAL (Stationary, Active Hinged Left)

ASR (Active Hinged Right, Stationary)

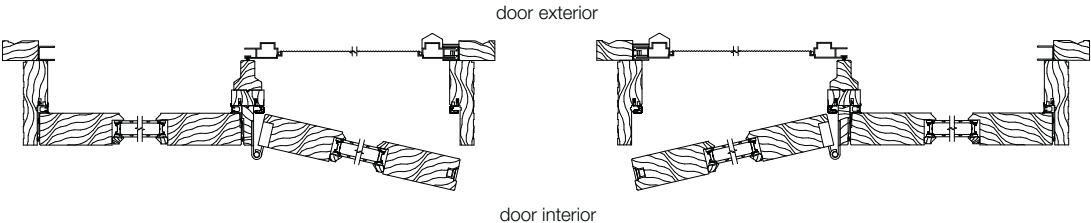

AL (French, Hinged Left, Active)

AR (French, Hinged Right, Active)

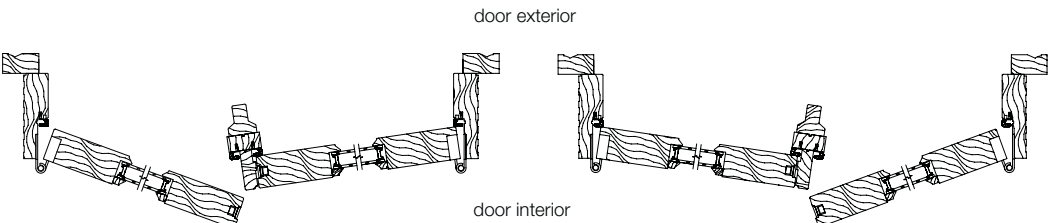

NOTE: Drawings are not to scale. Additional and the most current drawings are available in the Architect Library at www.kolbe-kolbe.com.

Inswing Entrance Doors Cross Section Drawings

Standard Inswing Entrance Door

Vertical Section

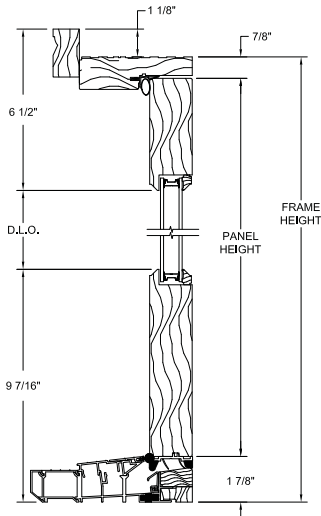

Full lite panel

Vertical Section

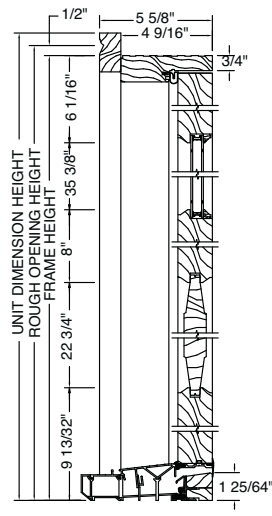

6'-8" EXAMPLE HEIGHT
ALUMINUM WEEP SILL
Raised panel

Horizontal Section

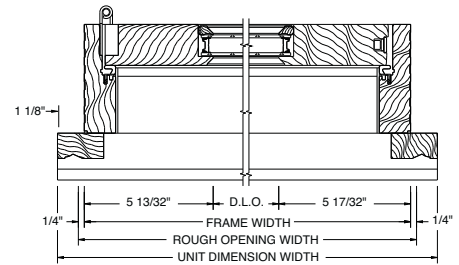

NOTE: Drawings are not to scale. Additional and the most current drawings are available in the Architect Library at www.kolbe-kolbe.com.

Two-Wide Inswing Entrance French Doors

Horizontal Section

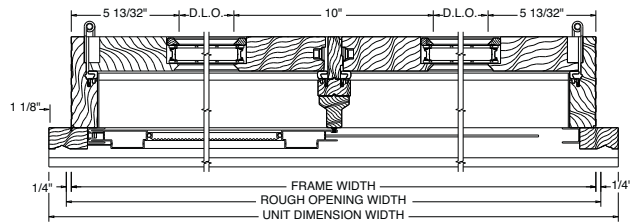

Inswing Entrance Door with Sidelite

Horizontal Section

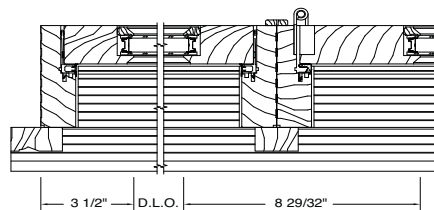



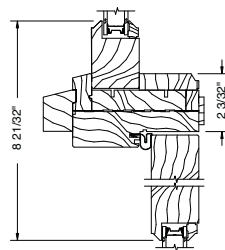



Rectangular Transom Stacked over Inswing Entrance Doors

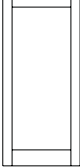
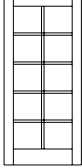
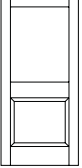
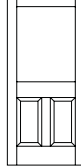
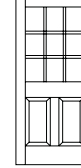

NOTE: Drawings are not to scale. Additional and the most current drawings are available in the Architect Library at www.kolbe-kolbe.com.

Outswing Entrance Doors Panel Designs

Outswing Entrance Door Panel Designs

										
Sash Design#:	KK610	KK625	KK6110	KK6210	KK6233	KK108-6	KK6110-30	KK6210-30	KK6110-24	KK6210-24
	Full Lite	2W5H Pattern	1 Lite over 1 Panel, 8" Cross Rail at 40"	1 Lite over 2 Panels, 8" Cross Rail at 40"	1 Lite over 2 Panels, 8" Cross Rail at 40" with 3W3H Pattern	6 Panels	1 Lite over 1 Panel, 4-5/8" Cross Rail at 30"	1 Lite over 2 Panels, 4-5/8" Cross Rail at 30"	1 Lite over 1 Panel, 4-5/8" Cross Rail at 24"	1 Lite over 2 Panels, 4-5/8" Cross Rail at 24"

NOTE: Sash design KK625 has TDL or PDL in the configuration shown. If a different configuration pattern is needed, specify sash design KK610 or KK6210 and the type of divided lite configuration desired.

Not all panel designs are available in all sizes.

Not all panel designs are shown; see your local Kolbe distributor for further assistance.

Dimension Calculations

Elevation charts provide wood unit dimensions for units with the standard 1 15/16" brickmould. Below are the calculations to determine the frame size of units with brickmould.

	Width	Height
1-15/16" brickmould; U.D. to F.S.	-2 1/2"	-1 1/4"
3-1/2" flat or profiled casing; U.D. to F.S.	-5 5/8"	-2 13/16"
3-1/2" casing and backband; U.D. to F.S.	-7 1/8"	-3 9/16"

F.S. to Panel O.S.M. (1-wide, wood)	-2 13/32"	-2 19/32"
Panel O.S.M. to G.S. (1-wide, wood)	-8 1/8"	-11 3/32"
Panel Opening Width to G.S. (2-wide)	-17 3/8" ÷ 2	
(3-wide)	-26 5/16" ÷ 3	
F.S. to Panel Opening Width	-2 1/8"	
G.S. to D.L.O.	-1"	-1"

Note: Dimension calculations for sidelites and transoms may be obtained from your Kolbe dealer.
Clear opening dimensions can be found on pg. 205.

F.S. = Frame Size • G.S. = Glass Size • O.S.M. = Outside Measurement
D.L.O. = Daylight Opening • U.D. = Unit Dimension

Outswing Entrance Doors Elevation Charts

Outswing Entrance Doors

U.D.	2'-4 23/32"	4'-5 3/8"	2'-10 23/32"	5'-5 3/8"	3'-0 23/32"	5'-9 3/8"	3'-4 23/32"	6'-5 3/8"
R.O.	2'-2 23/32"	4'-3 3/8"	2'-8 23/32"	5'-3 3/8"	2'-10 23/32"	5'-7 3/8"	3'-2 23/32"	6'-3 3/8"
G.S.*	15 11/16"	15 11/16"	21 11/16"	21 11/16"	23 11/16"	23 11/16"	27 11/16"	27 11/16"
6'-11 27/32"								
6'-11 3/32"								
68 29/32"								
7'-3 27/32"								
7'-3 3/32"								
72 29/32"								
8'-3 27/32"								
8'-3 3/32"								
84 29/32"								

Outswing Patio Doors

U.D.	2'-9 11/32"	5'-2 5/8"	3'-3 11/32"	6'-2 5/8"
R.O.	2'-7 11/32"	5'-0 5/8"	3'-1 11/32"	6'-0 5/8"
G.S.*	20 5/16"	20 5/16"	26 5/16"	26 5/16"
6'-8 5/8"				
6'-7 7/8"				
65 11/16"				
8'-0 23/32"				
7'-11 31/32"				
81 29/32"				

NOTE: All measurements are nominal. Elevation charts are not to scale. Dimensions are given for active units; dimensions of stationary units may vary.

Some installation procedures will require a larger rough opening than noted (i.e. installations utilizing our installation clips), therefore, you may need to increase the rough opening size accordingly. Rough opening gaps may be increased up to a maximum of 1/2" on all sides and still be within good practice guidelines. For rough opening recommendations, see pg. 196.

* Glass size widths are shown per panel for one-lite glass. For TDL glass sizes contact your supplier.

PRODUCT CODES:

To orders, use the product number shown, specify outswing. When ordering single units, specify stationary, hinged left or hinged right. Operation is viewed from the exterior.

U.D. = Unit Dimension • R.O. = Rough Opening • G.S. = Glass Size

Outswing Entrance Doors Elevation Charts

Segment Head Outswing Entrance Doors

U.D.	2'-4 23/32"	4'-5 3/8"	2'-10 23/32"	5'-5 3/8"	3'-0 23/32"	5'-9 3/8"	3'-4 23/32"	6'-5 3/8"
R.O.	2'-2 23/32"	4'-3 3/8"	2'-8 23/32"	5'-3 3/8"	2'-10 23/32"	5'-7 3/8"	3'-2 23/32"	6'-3 3/8"
G.S.*	15 11/16"	15 11/16"	21 11/16"	21 11/16"	23 11/16"	23 11/16"	27 11/16"	27 11/16"
6'-11 27/32" 6'-11 3/32" 68 29/32"								
7'-3 27/32" 7'-3 3/32" 72 29/32"								
8'-3 27/32" 8'-3 3/32" 84 29/32"								

NOTE: All measurements are nominal. Elevation charts are not to scale.

Dimensions are given for active units; dimensions of stationary units may vary.

Some installation procedures will require a larger rough opening than noted (i.e. installations utilizing our installation clips), therefore, you may need to increase the rough opening size accordingly. Rough opening gaps may be increased up to a maximum of 1/2" on all sides and still be within good practice guidelines. For rough opening recommendations, see pg. 196.

* Approximate glass sizes are given; true glass sizes may vary depending on the radius involved.

PRODUCT CODES:

To order, use the product number shown and specify outswing. When ordering single units, specify stationary, hinged left or hinged right. Operation is viewed from the exterior.

U.D. = Unit Dimension • R.O. = Rough Opening • G.S. = Glass Size

Outswing Entrance Door Sidelites

U.D.	1'-4 3/4"	1'-6 3/4"	1'-8 3/4"	1'-10 3/4"
R.O.	1'-2 3/4"	1'-4 3/4"	1'-6 3/4"	1'-8 3/4"
G.S.*	7 5/8"	9 5/8"	11 5/8"	13 5/8"
6'-11 27/32" 6'-11 3/32" 68 29/32"				
WXD1068S	WXD1268S	WXD1468S	WXD1668S	
7'-3 27/32" 7'-3 3/32" 72 29/32"				
WXD1070S	WXD1270S	WXD1470S	WXD1670S	
8'-3 27/32" 8'-3 3/32" 84 29/32"				
WXD1080S	WXD1280S	WXD1480S	WXD1680S	

Outswing Entrance Door Sidelite Panel Designs

Sash Design#:	KK510	KK515	KK5110	KK5110-30	KK5110-24
	Full Lite	1W5H Pattern	1 Lite over 1 Panel, 8" Cross Rail at 40"	1 Lite over 1 Panel, 4-5/8" Cross Rail at 30"	1 Lite over 1 Panel, 4-5/8" Cross Rail at 24"

NOTE: All measurements are nominal. Elevation charts are not to scale.

Some installation procedures will require a larger rough opening than noted (i.e. installations utilizing our installation clips), therefore, you may need to increase the rough opening size accordingly. Rough opening gaps may be increased up to a maximum of 1/2" on all sides and still be within good practice guidelines. For rough opening recommendations, see pg. 196.

* Glass size widths are shown for one-lite glass. For TDL glass sizes, contact your Kolbe window and door supplier.

PRODUCT CODES:

To order, use the product code shown and specify wood profile.

Sidelite sash design KK515 has TDL or PDL in the configuration shown. If a different configuration pattern is needed, specify sash design KK510 or KK5110 and the type of configuration desired.

Not all panel designs are available in all sizes.

Not all panel designs are shown; see your local Kolbe distributor for further assistance.

U.D. = Unit Dimension • R.O. = Rough Opening • G.S. = Glass Size

Outswing Entrance Doors Elevation Charts

Outswing Entrance Doors | Rectangular Transoms

U.D.	2'-4 23/32"	2'-10 23/32"	3'-0 23/32"	3'-4 23/32"	4'-5 3/8"	5'-5 3/8"	5'-9 3/8"	6'-5 3/8"
R.O.	2'-2 23/32"	2'-8 23/32"	2'-10 23/32"	3'-2 23/32"	4'-3 3/8"	5'-3 3/8"	5'-7 3/8"	6'-3 3/8"
G.S.	20 3/32"	26 3/32"	28 3/32"	32 3/32"	44 3/4"	56 3/4"	60 3/4"	68 3/4"
1'-1 1/8"								
1'-0"								
1'-4"								
1'-5 1/8"								
1'-6"								
1'-7 1/8"								
1'-8"								
1'-9 1/8"								
1'-10"								
1'-11 1/8"								
1'-12 1/8"								
1'-13 1/8"								
1'-14 1/8"								
1'-15 1/8"								
1'-16 1/8"								
1'-17 1/8"								
1'-18 1/8"								
1'-19 1/8"								
1'-20 1/8"								
1'-21 1/8"								
1'-22 1/8"								
1'-23 1/8"								
1'-24 1/8"								
1'-25 1/8"								
1'-26 1/8"								
1'-27 1/8"								
1'-28 1/8"								
1'-29 1/8"								
1'-30 1/8"								
1'-31 1/8"								
1'-32 1/8"								
1'-33 1/8"								
1'-34 1/8"								
1'-35 1/8"								
1'-36 1/8"								
1'-37 1/8"								
1'-38 1/8"								
1'-39 1/8"								
1'-40 1/8"								
1'-41 1/8"								
1'-42 1/8"								
1'-43 1/8"								
1'-44 1/8"								
1'-45 1/8"								
1'-46 1/8"								
1'-47 1/8"								
1'-48 1/8"								
1'-49 1/8"								
1'-50 1/8"								
1'-51 1/8"								
1'-52 1/8"								
1'-53 1/8"								
1'-54 1/8"								
1'-55 1/8"								
1'-56 1/8"								
1'-57 1/8"								
1'-58 1/8"								
1'-59 1/8"								
1'-60 1/8"								
1'-61 1/8"								
1'-62 1/8"								
1'-63 1/8"								
1'-64 1/8"								
1'-65 1/8"								
1'-66 1/8"								
1'-67 1/8"								
1'-68 1/8"								
1'-69 1/8"								
1'-70 1/8"								
1'-71 1/8"								
1'-72 1/8"								
1'-73 1/8"								
1'-74 1/8"								
1'-75 1/8"								
1'-76 1/8"								
1'-77 1/8"								
1'-78 1/8"								
1'-79 1/8"								
1'-80 1/8"								
1'-81 1/8"								
1'-82 1/8"								
1'-83 1/8"								
1'-84 1/8"								
1'-85 1/8"								
1'-86 1/8"								
1'-87 1/8"								
1'-88 1/8"								
1'-89 1/8"								
1'-90 1/8"								
1'-91 1/8"								
1'-92 1/8"								
1'-93 1/8"								
1'-94 1/8"								
1'-95 1/8"								
1'-96 1/8"								
1'-97 1/8"								
1'-98 1/8"								
1'-99 1/8"								
1'-100 1/8"								

Outswing Patio Doors | Rectangular Transoms

U.D.	2'-9 11/32"	3'-3 11/32"	5'-2 5/8"	6'-2 5/8"
R.O.	2'-7 11/32"	3'-1 11/32"	5'-0 5/8"	6'-0 5/8"
G.S.	24 3/4"	30 3/4"	54"	66"
1'-1 1/8"				
1'-0"				
1'-4"				
1'-5 1/8"				
1'-6"				
1'-7 1/8"				
1'-8"				
1'-9 1/8"				
1'-10"				
1'-11 1/8"				
1'-12 1/8"				
1'-13 1/8"				
1'-14 1/8"				
1'-15 1/8"				
1'-16 1/8"				
1'-17 1/8"				
1'-18 1/8"				
1'-19 1/8"				
1'-20 1/8"				
1'-21 1/8"				
1'-22 1/8"				
1'-23 1/8"				
1'-24 1/8"				
1'-25 1/8"				
1'-26 1/8"				
1'-27 1/8"				
1'-28 1/8"				
1'-29 1/8"				
1'-30 1/8"				
1'-31 1/8"				
1'-32 1/8"				
1'-33 1/8"				
1'-34 1/8"				
1'-35 1/8"				
1'-36 1/8"				
1'-37 1/8"				
1'-38 1/8"				
1'-39 1/8"				
1'-40 1/8"				
1'-41 1/8"				
1'-42 1/8"				
1'-43 1/8"				
1'-44 1/8"				
1'-45 1/8"				
1'-46 1/8"				
1'-47 1/8"				
1'-48 1/8"				
1'-49 1/8"				
1'-50 1/8"				
1'-51 1/8"				
1'-52 1/8"				
1'-53 1/8"				
1'-54 1/8"				
1'-55 1/8"				
1'-56 1/8"				
1'-57 1/8"				
1'-58 1/8"				
1'-59 1/8"				
1'-60 1/8"				
1'-61 1/8"				
1'-62 1/8"				
1'-63 1/8"				
1'-64 1/8"				
1'-65 1/8"				
1'-66 1/8"				
1'-67 1/8"				
1'-68 1/8"				
1'-69 1/8"				
1'-70 1/8"				
1'-71 1/8"				
1'-72 1/8"				
1'-73 1/8"				
1'-74 1/8"				
1'-75 1/8"				
1'-76 1/8"				
1'-77 1/8"				
1'-78 1/8"				
1'-79 1/8"				
1'-80 1/8"				
1'-81 1/8"				
1'-82 1/8"				
1'-83 1/8"				
1'-84 1/8"				
1'-85 1/8"				
1'-86 1/8"				
1'-87 1/8"				
1'-88 1/8"				
1'-89 1/8"				
1'-90 1/8"				
1'-91 1/8"				
1'-92 1/8"				
1'-93 1/8"				
1'-94 1/8"				
1'-95 1/8"				
1'-96 1/8"				
1'-97 1/8"				
1'-98 1/8"				
1'-99 1/8"				
1'-100 1/8"				

NOTE: All measurements are nominal. Elevation charts are not to scale.

Rectangular transom units are sash set as standard.

The units shown are stand-alone units. Adjustments may be required when stacking over other units; adjustments will be made in the factory.

Transom dimensions shown are for units stacked above active doors; dimensions for transoms stacked above stationary doors may vary.

Divided lite configurations must be specified when ordering.

Some installation procedures will require a larger rough opening than noted (i.e. installations utilizing our installation clips), therefore, you may need to increase the rough opening size accordingly. Rough opening gaps may be increased up to a maximum of 1/2" on all sides and still be within good practice guidelines. For rough opening recommendations, see pg. 196.

PRODUCT CODES:

To order transoms, use the product number shown.

U.D. = Unit Dimension • R.O. = Rough Opening • G.S. = Glass Size

Outswing Entrance Doors Cross Section Drawings

Hinging For Outswing Entrance Doors

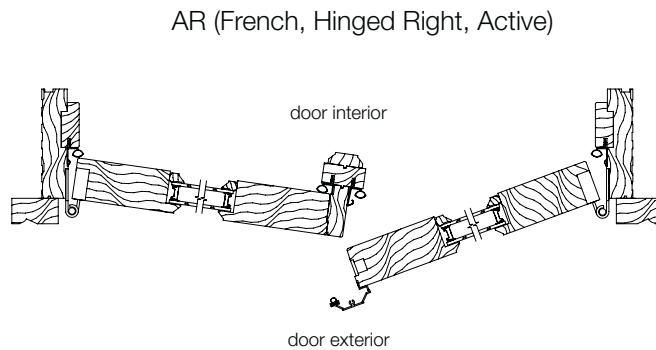
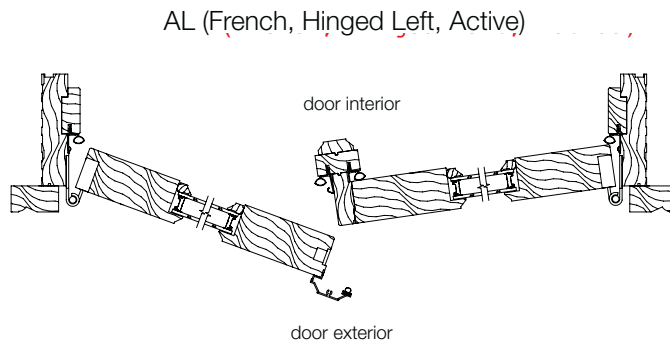
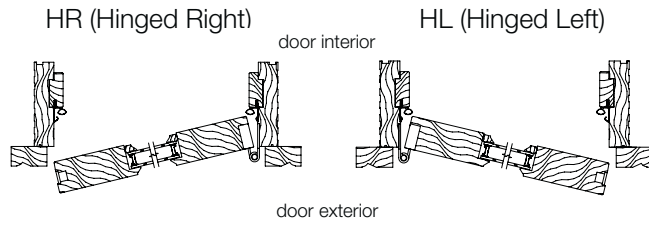

Operation is viewed from the exterior.

Outswing Entrance Doors Cross Section Drawings

Standard Outswing Entrance Door

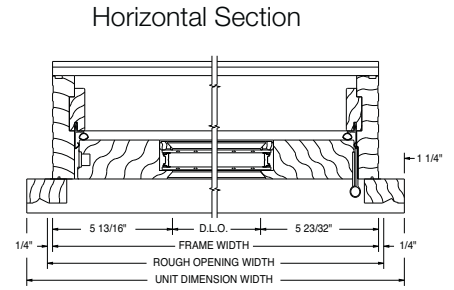
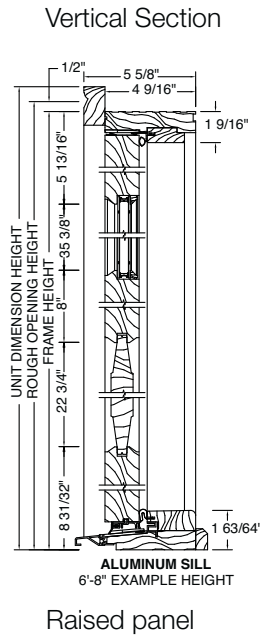
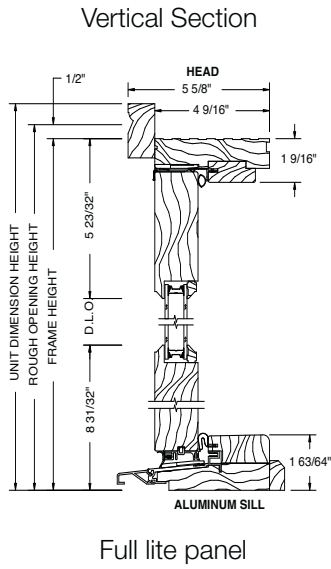

NOTE: Drawings are not to scale. Additional and the most current drawings are available in the Architect Library at www.kolbe-kolbe.com.

Two-Wide Outswing French Doors

Horizontal Section

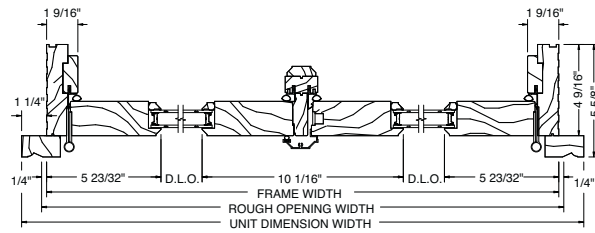

Outswing Entrance Door with Sidelite

Horizontal Section

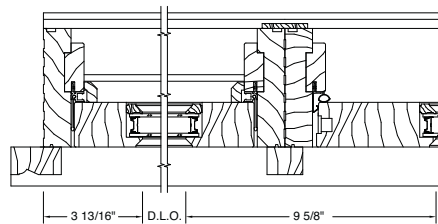

Rectangular Transom Stacked over Outswing Entrance Door

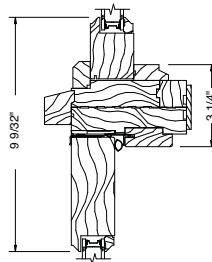

NOTE: Drawings are not to scale. Additional and the most current drawings are available in the Architect Library at www.kolbe-kolbe.com.

Craftsman Collection Panel Designs

Craftsman Door Panel Designs

Square Panels and Glass Lites

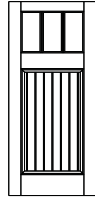

PA 4661-3

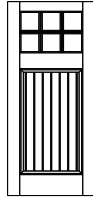

PA 4661-6

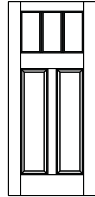

PA 4662-3

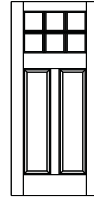

PA 4662-6

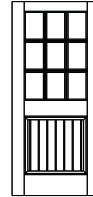

PA 4982

Square Panels and Arch-Top Glass Lites

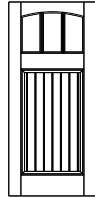

PR 4661-3

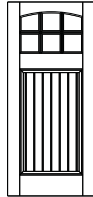

PR 4661-6

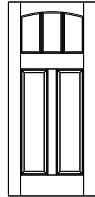

PR 4662-3

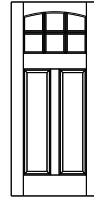

PR 4662-6

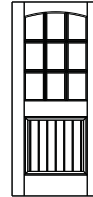

PR 4982

Square, Beaded 2-Panel

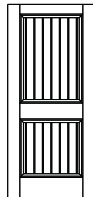

PL 4082

Arch-Top, Beaded 2-Panel

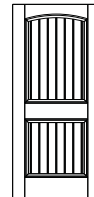

S 4082

Square 2-Panel

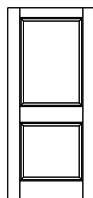

R 4082

Arch-Top 2-Panel

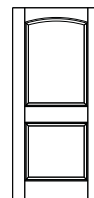

T 4082

NOTE: All measurements are nominal. Elevation drawings are not to scale.

Some installation procedures will require a larger rough opening than noted (i.e. installations utilizing our installation clips), therefore, you may need to increase the rough opening size accordingly. Rough opening gaps may be increased up to a maximum of 1/2" on all sides and still be within good practice guidelines. For rough opening recommendations, see pg. 196.

PRODUCT CODES:

To order, specify Craftsman Collection, the number shown, as well as inswing or outswing operation. If ordering single doors, specify right or left hinging.

Craftsman Sidelites



PAS 4661-1

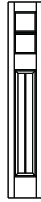

PAS 4661-2



PAS 4662-1



PAS 4662-2



PAS 4982

Inswing Rough Openings

Single Doors		Double Doors	
2-6	32-1/8"	5-0	62-11/16"
2-8	34-1/8"	5-4	66-11/16"
3-0	38-1/8"	6-0	74-11/16"
3-6	44-1/8"		
Sidelites		Heights	
1-0	14-1/4"	6-8	83-7/32"
1-2	16-1/4"	7-0	87-7/32"
1-4	18-1/4"	8-0	99-7/32"
1-6	20-1/4"		

Outswing Rough Openings

Single Doors		Double Doors	
2-6	32-23/32"	5-0	63-3/8"
2-8	34-23/32"	5-4	67-3/8"
3-0	38-23/32"	6-0	75-3/8"
3-6	44-23/32"		
Sidelites		Heights	
1-0	14-3/4"	6-8	83-3/32"
1-2	34-3/4"	7-0	87-3/32"
1-4	18-3/4"	8-0	99-3/32"
1-6	20-3/4"		

Dimension Calculations

Inswing	Width	Height
F.S. to Panel O.S.M. (1-wide, active)	-1 13/16"	-2 23/32"
(1-wide, sidelite)	-1 3/4"	-2 23/32"
(2-wide, French)	-2 9/16" ÷ 2	-2 23/32"

Outswing	Width	Height
F.S. to Panel O.S.M. (1-wide, active)	-2 13/32"	-2 19/32"
(1-wide, sidelite)	-2 3/8"	-2 19/32"
(2-wide, French)	-3 1/4" ÷ 2	-2 19/32"

Note: Dimension calculations for transoms may be obtained from your supplier.

Elevation charts provide frame sizes for units without brickmould.

Below are the calculations to determine overall unit dimensions for units with brickmould.

1-15/16" brickmould; F.S. to U.D.	+2 1/4"	+1 1/8"
3-1/2" flat or profiled casing; F.S. to U.D.	+5 3/8"	+2 11/16"
3-1/2" flat casing & backband; F.S. to U.D.	+6 7/8"	+3 7/16"

F.S. = Frame Size • O.S.M. = Outside Measurement
U.D. = Unit Dimension

Divided Lites | Cross Section Drawings

Beveled Performance Divided Lites

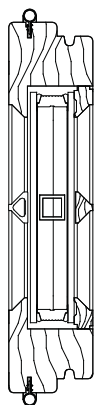

5/8"
beveled
PDL

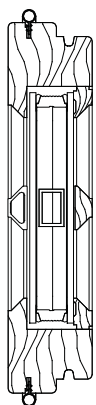

7/8"
beveled
PDL

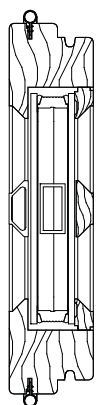

1-1/8"
beveled
PDL

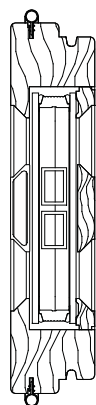

1-3/4"
beveled
PDL

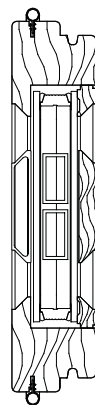

2-1/4"
beveled
PDL

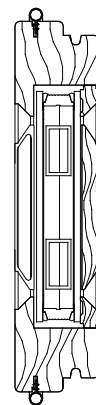

4-1/2"
beveled
PDL

Ovolo Performance Divided Lites

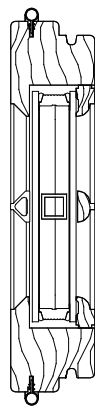

5/8"
ovolo
PDL

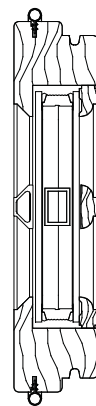

7/8"
ovolo
PDL

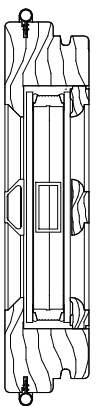

1-1/8"
ovolo
PDL



1-3/4"
ovolo
PDL

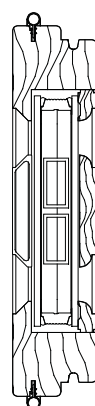

2-1/4"
ovolo
PDL

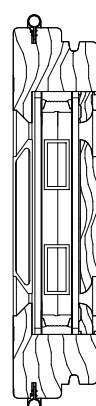

4-1/2"
ovolo
PDL

NOTE: Drawings are not to scale. Additional and the most current drawings are available in the Architect Library at www.kolbe-kolbe.com.

Square Performance Divided Lites

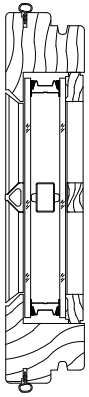

5/8"
square
PDL

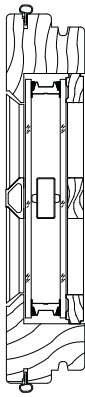

7/8"
square
PDL

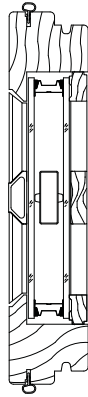

1-1/8"
square
PDL

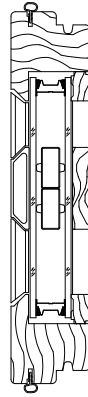

1-3/4"
square
PDL

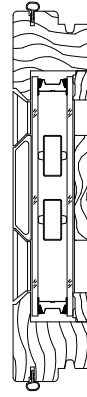

2-1/4"
square
PDL

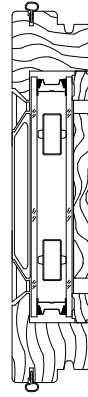

4-1/2"
square
PDL

True Divided Lites

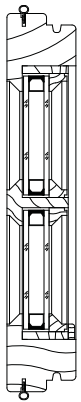

1-1/8"
beveled
TDL

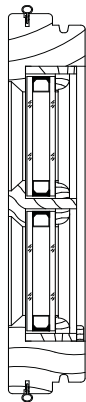

1-1/8"
ovolo
TDL

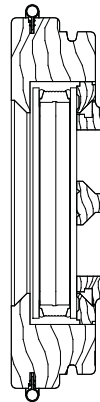

7/8" beveled
removable
grilles

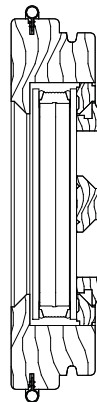

1-1/8" beveled
removable
grilles

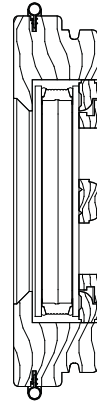

7/8" ovolo
removable
grilles

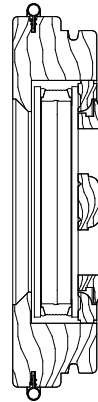

1-1/8" ovolo
removable
grilles

Wood Removable Grilles

NOTE: Drawings are not to scale. Additional and the most current drawings are available in the Architect Library at www.kolbe-kolbe.com.





Options

Craftsmanship and artistry are hallmarks of Kolbe products. We build innovative windows and doors with a wide array of options. But, don't let the standard options limit your imagination.

At Kolbe, we love a good challenge. We welcome projects that require special wood species, custom divided lite patterns, unique shapes, custom finish colors, unusual mulling configurations – you dream it, we'll build it. We can even help inspire and develop your designs. Whatever the opening, we will help you fill it with style. Our windows and doors are built to order, which allows you to choose the options that best fit with the design of your home and vision for your project. We offer many customizable options that blend beautifully with your home's décor.



Glass Options

Kolbe offers numerous options to achieve the optimum energy efficiency for the geographic region in which you live.

LoE Coatings

To improve thermal efficiency, microscopically thin coatings are applied to the glass that is used in the insulated glass units incorporated into our windows and doors. The state-of-the-art application of the LoE coating is known as sputter coating. There are a number of coating options available, and the appropriate one should be chosen for either the specific geographic region or building construction design required to help achieve the highest level of energy performance possible. As standard, we use double strength annealed glass in most units, with double-pane insulating LoE²-270 glass. In energy zones with a warmer climate, LoE coatings can be used to significantly block the amount of heat transfer, reducing the load of air conditioning systems. In colder climate zones, LoE coatings can be used to allow for high solar heat gain, resulting in reduced heating and cooling costs throughout the year. LoE coatings also reduce the potential for condensation, as well as provide protection against fading of furniture, fabrics and carpeting. Numerous glass options and combinations are available for different applications and various geographic regions. Special glass requests are also welcomed.

LoE-180

When the weather turns frigid, LoE-180 glass is the perfect cold remedy. It keeps homes warmer and more comfortable by blocking heat loss to the outside and letting the sun's heat stream in to increase solar heat gain.

LoE²-240

Wherever glare is a problem, LoE²-240 glass is a solution to maintain year-round comfort in warmer climates. In summer, it blocks oppressive solar heat gain and maintains cool glass temperatures. When winter rolls around, it keeps inside glass temperatures warm.

LoE²-270

LoE²-270 glass delivers year-round comfort in most types of weather. Offering a balance of high clarity and low solar heat gain, LoE²-270 is standard in most Kolbe products. In summer, it rejects the sun's heat and damaging UV rays. In winter, it reflects heat back into the room.

LoE³-366

For warm climates, LoE³-366 delivers a balance of solar control and high visibility. This coating helps provide protection of fading, blocking up to 95% of the sun's damaging rays.

ThermaPlus™ LoE

ThermaPlus LoE is an additional interior coating applied to help meet the strictest energy requirements and provide protection against heat loss and UV damage.

Argon Gas

Argon gas is a colorless, odorless, non-toxic, naturally-occurring element that is inert, meaning it will not react with other elements or gasses. Because argon gas has a thermal conductivity 30% lower than air, the use of argon gas in a LoE coated insulated glass unit allows it to provide for an incremental improvement to the overall U-factor of the unit. For increased energy efficiency, argon is supplied, at no additional cost, in all LoE coated insulated glass units, with the exception of those units when glass dimensions are less than 14" x 14" or units that require capillary/breather tubes due to being shipped over or installed in high altitude elevations. Units constructed without argon gas will have higher U-values.

High altitude situations occur when Kolbe double pane insulated glass units are shipped over or installed in areas that begin at 5000 feet above sea level. For triple pane insulated glass units, high altitude begins at 3500 feet above sea level. To find the energy performance for units in high altitude situations, use our energy database at kolbe-kolbe.com and select **Air** as the fill option for double or triple pane glass.

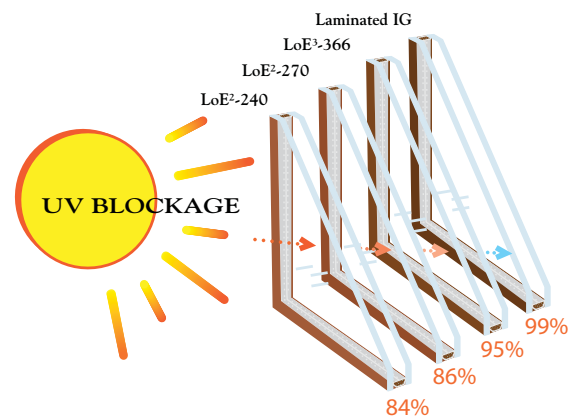

NOTE: Tested units include argon. The laminate has 1/4" inner pane. Based on Lawrence Berkeley Lab (LBL) Window 5.2 © 2003 analysis for classical UV transmission data.

Thermal Efficiency

Inert gas dissipates over the life of the insulated glass unit. Kolbe does not warrant the amount or percentage of argon present in insulating glass or a specific level of unit thermal efficiency at any time after manufacture. Visit the energy data section of our website at kolbe-kolbe.com to select and view your specific window and its listed energy performance values.

Thermo-Edge Spacer

Kolbe's standard glass offerings are complemented by a state-of-the-art, stainless steel spacer bar system on most units. The advanced design of this system incorporates a stainless steel spacer with airtight bent corners and a dual-seal construction of compressed polyisobutylene (PIB) and silicone. Desiccants are contained in the spacer to eliminate the potential for moisture. These features combine to reduce the thermal transmission through the edge seal, creating better energy performance and increasing the roomside glass temperature while reducing the potential for condensation at the sash to glass interface as compared to aluminum spacer designs. Thermo-Edge spacers are one of the many quality details that define Kolbe windows and doors. Thermo-Edge spacers are not available on very small radius units, units with ½" insulated glass, with the champagne or dark Bronze Anodized spacer option, units with "pencil" bar grilles-in-the-airspace, or true divided lites. Available in stainless steel (standard) and black painted.

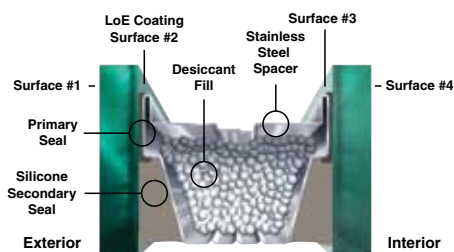

Additional Glass Options

Triple Pane

Provides a greater energy performing window that keeps indoor air warm and comfortable, prevents heat loss and lowers your heating bills. Available with a variety of LoE coatings that best suit your needs.

Mountain Air Energy Package

Specifically designed to meet a U-factor of .30 without argon gas. Consists of a specially-constructed frame, second-generation ThermaPlus glass with LoE³-366 and a capillary/breather tube within the insulating glass unit. Available on Crank-Out Casements and Awnings, Sterling Double Hungs, and Studio/Picture, Transom and Direct Set units to match Crank-Out Casements and Sterling Double Hungs.



Preserve Film

A protective film that protects the glass surfaces from scratches during transit and construction, as well as reducing the time involved in job site clean-up.

Tinted, Colored or Patterned

Provides shading, privacy or visual interest.

Finely Crafted Glass *(not available with argon gas)*

Decorative glass created with a variety of coming options.

Tempered

Standard in Kolbe doors to address safety concerns. Also available in window units to meet specific building codes.

Laminated

Benefits include safety, security, sound control and provides the ultimate in UV blockage.

Impact

Glazing utilized to withstand harsh environmental conditions, especially in coastal regions. Combined with an impact product, such as K-Force[®], this product offers the highest level of security.

Neat[®]

Harnesses the sun's UV rays to loosen dirt so water can rinse it away, leaving windows virtually spotless. A special sputter-coating process makes the exterior glass surface ultra smooth, so the water "sheets off" more readily than it would on uncoated glass, allowing you to spend less time cleaning.

NOTE: Not all glass is available on all products. Please contact your Kolbe dealer for product specifics.

LoE², LoE²-240, LoE²-270, LoE³-366, Neat and Preserve are trademarks of Cardinal IG.

LoE insulating glass with a stainless steel spacer bar carries a 20-year warranty. Not all glass options listed have the same glass warranty. Please contact your dealer for details.

Divided Lites

Expand the character of your home or project by adding one of our divided lite options to your windows and doors. Choose anything from a traditional, colonial-style pattern to a unique, custom design to accentuate the overall appearance of your project. Kolbe offers four types of divided lites: grilles-in-the-airspace, wood removable grilles, performance divided lites and true divided lites. As standard, wood bars have a beveled profile, however, an ovolo profile or a square profile is also available. (See pg. 192, *Glazing Beads & Muntin Bars.*) Divided lite cross section drawings can be found on pgs. 180-181.



Performance Divided Lites

Kolbe's performance divided lite (PDL) glazing system gives the appearance of true divided lites without sacrificing energy efficiency. Extruded aluminum bars are adhered to the exterior and unfinished pine bars are adhered to the interior of the single lite of insulating glass. Aesthetically pleasing spacer bars are installed within the insulating glass unit. Together, these bars create the illusion of true divided lites. PDL bars are available in 5/8", 7/8", 1-1/8", 1-3/4", 2-1/4" or 4-1/2" bar widths. The exterior finish of the aluminum bars will match the exterior finish on the unit. Variations on the PDL option may include custom grille patterns, custom bar widths or no spacer bars. Some designs may have a composite material for the exterior PDL bar.

True Divided Lites

True divided lites (TDL) give each unit the traditional look often found in historical projects. Units with TDL are comprised of wood muntin bars in between glass panes. The horizontal and vertical, colonial-style wood TDL bars use interlocking half-lap joints. Profile shadow lines enhance the warm, richness of the wood on both the interior and exterior. The exterior finish on the bars will match the exterior finish of the unit. TDL options include custom patterns and bar widths, other wood species and interior stain or paint finishes. Depending on glass options chosen, standard bar widths are available in 7/8" or 1-1/8". TDL glass units are not filled with argon gas.

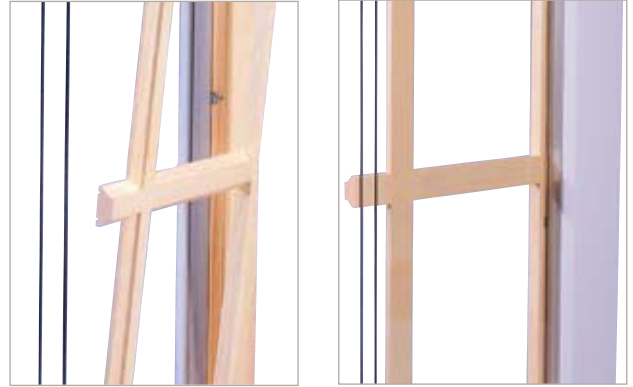

Grilles-in-the-Airspace

Grilles-in-the-airspace are constructed with aluminum bars sealed between two panes of insulating glass, offering the look of divided panes while reducing cleaning time. For units with 7/8" insulating glass, contoured, 3/4" wide bars are standard in White, Beige, Sand, Rustic, Hartford Green and Chutney. Optional colors are light wood and dark faux finishes. Flat, 5/8" wide grille bars are also available in White, Beige, Sand, Rustic, Hartford Green, Chutney, light wood and dark wood faux finishes and Brass. Two-tone contour or flat grilles are available with either light or dark wood faux finishes to the interior and White to the exterior. Also available for 7/8" insulating glass are 5/16" wide Brass and Pewter pencil bars.

Wood Removable Grilles

Wood grilles are built with a full surround frame and bars that interlock at the joints for stability. Grilles are applied to the interior of the window using an exclusive hidden clip system.* This system makes unsightly pins and attachment points unnecessary and removal or replacement easy. As standard, bars are constructed of unfinished pine and are 7/8" wide on windows and 1-1/8" wide on doors. Custom grille patterns, bar widths, wood species and interior stains may be available upon request.

* A clear pin system will be used for Garden-Aire sliding patio doors.

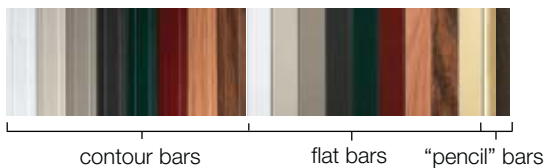

Wood Finish Options

Wood Species

Most of our wood windows and doors are built from pine as standard, but we often craft windows and doors from other wood species. Our wood species, including Mahogany, are sourced from managed forests. If a special wood species will enhance the beauty of your project, we'll do our best to achieve your vision. FSC-certified wood species are also available for green building projects (FSC® license code FSC-C019541). Some species can be used on the exterior. Contact your Kolbe dealer for specifics.



* Sourced from companies such as Lamboo, Inc.

Interior Finish Options

For units that are ready to install upon delivery, Kolbe's wood windows and doors can be prefinished on the interior with one of the water-based stains or paints shown. Stained units are given two coats of satin finish clear sealer. Because our interior finishes are water-based, low-VOC stains and paints, you can rest assured you've made an environmentally conscious decision. Custom colors are also available.

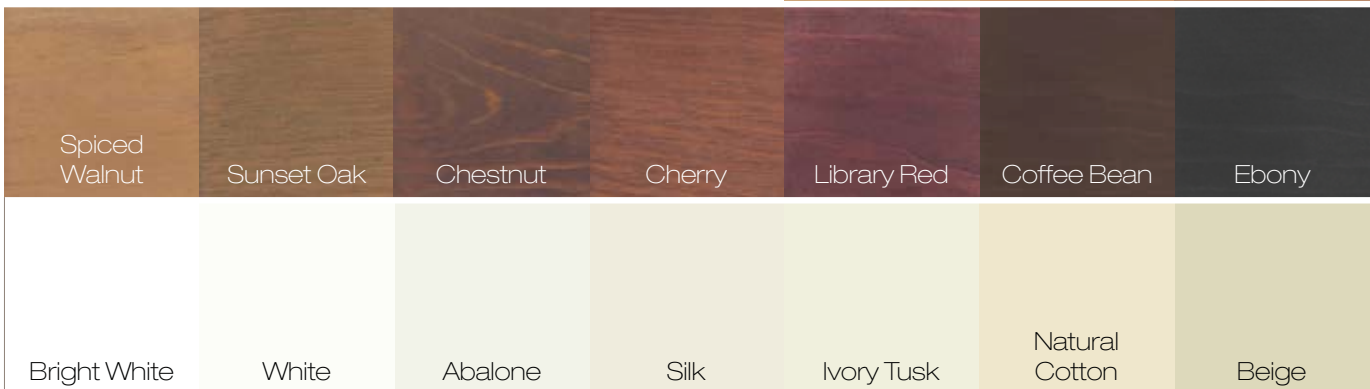
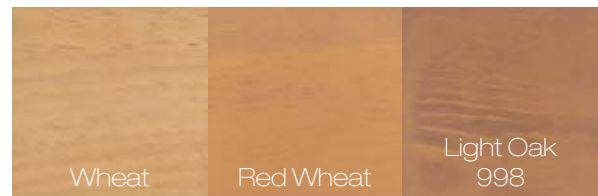

Printed images of wood species and stain options will vary from actual product colors. Selections should be made based on color samples available from your Kolbe dealer. Stain colors are shown on pine. A double coat clear finish is also offered. Since no two trees are identical, wood can be expected to differ both in color and graining. These factors will influence the stain's final color.

Exterior Finish Options

Primer

Most Heritage Series windows are coated on the exterior with latex primer, ready for your choice of topcoat. An optional urethane primer is available on most Heritage Series windows and doors.

K-Kron II

Kolbe's Heritage Series wood products can be coated on the exterior with K-Kron II, our exterior paint finish that offers a way to enhance and preserve the look of wood windows and doors. Custom colors are also available. Contact your dealer for exterior finish samples. The K-Kron II finishing system consists of three steps. **Step 1:** Wood preservatives are applied to help resist water, insects and fungus. **Step 2:** A urethane primer is applied using a controlled multi-step spray method to help seal the wood and provide a tough bonding surface for the final topcoat. **Step 3:** The topcoat finish is applied using a controlled spray system, which provides consistent coverage to the exterior surface. K-Kron II carries a 10-year warranty to help resist chalking, chemical attack, as well as damage from salt, wind, sleet and snow. K-Kron II is offered in over 30 colors, with custom colors available.



Some options for our products may have limited color offerings or may incur a nominal charge. Check with your Kolbe dealer for further details on pricing and availability. Printed images of exterior finishes may vary slightly from actual colors. Selections should be made based on actual color samples available from your Kolbe dealer.

Options & Accessories

Interior Casing

Accent the interior of windows and doors with interior casing by Kolbe. As standard, choose either 2-1/8" wide ranch casing or 2-1/4" wide colonial casing. Ranch and colonial casings are available in unfinished pine or oak, ready for paint or stain. Curved radius casing is available to match the curves of Kolbe radius units.



Specialty mouldings are available in pine, oak and other wood species. Shipped loose for field application, specialty mouldings are available in a wide variety of profiles, some of which are shown below.

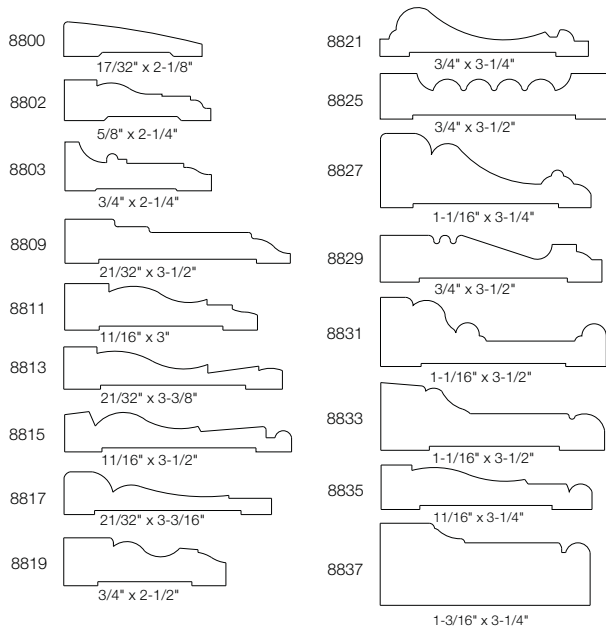

Corner Blocks

Giving windows and doors a signature look has never been easier. Kolbe offers corner blocks and rosettes in pine or oak to complement interior and exterior architecture.



Exterior Brickmoulds & Casings

Accentuate the beauty of your windows and doors with Kolbe exterior brickmoulds and casings. As standard, Heritage Series units have Kolbe's 1-15/16" profiled brickmould (a). Options available include 3-1/2" profiled brickmould (b), 3-1/2" flat casing (c), 3-1/2" profiled brickmould with backband (d), or 3-1/2" flat casing with backband (e). Custom brickmoulds and casings are available. Contact your local Kolbe dealer for more information.

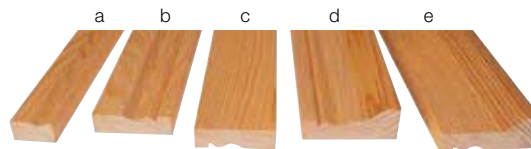

Wire Brush Finish

Most Kolbe wood windows and doors can be further enhanced by our wire brushed finish. Wire brushing creates a rugged texture and adds character – the perfect option to complement any rustic-styled home. Due to the nature of the finish, certain limitations apply. Contact your local Kolbe dealer for more information.

StormGuard

Kolbe's durable StormGuard combination storm/screen units provide extra protection from the outdoor elements, as well as provide greater energy efficiency. Units feature two glass inserts and one screen insert that can be removed from the interior for cleaning. Frames are constructed of extruded aluminum made of a lightweight alloy, which is easy to handle without sacrificing performance. Weatherstripping along the top and sides of all three inserts ensures a tight fit that will withstand harsh weather. Weep holes channel water out to help prevent damage to the window sill. The sight lines and profiles of StormGuard units closely match the window it complements, which means the unit will blend in and your view will not be obscured. Screen inserts have fiberglass mesh as standard; aluminum mesh is optional. StormGuards for Heritage Series windows are available in Ultra Pure White, White, Beige, Sand, Rustic, Hartford Green and Chutney. Only available for Sterling and Traditional double hungs as well as double sliders.



Double Hung
StormGuard
in White



Slider
StormGuard
in Beige



Sterling Double Hung Retractable Screen Kit

A retractable screen kit is offered for Kolbe Sterling double hungs, for those who prefer an unobstructed view at times. Wood components that match the interior wood species and finish disguise the screen hardware, revealing only the beauty of the window. When you do want to open your window and use the screen, operation is practically effortless. Simply press the pull bar down to the sill to engage the screen. A gentle push toward the exterior allows the screen to retract. BetterVue® fiberglass screen mesh is used as standard for a clearer view.

Included in the kit are all the components necessary for field installation on a Heritage Series Sterling double hung.

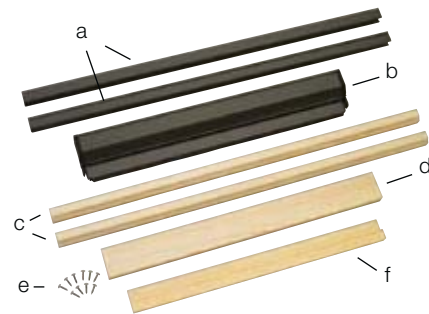

Sterling Double Hung Retractable Screen Kit components:

- | | |
|--|----------------------------|
| a - Side rails | d - Wood trim for housing |
| b - Cassette
(housing and pull bar) | e - Screws |
| c - Wood trim for side rails | f - Wood trim for pull bar |

Options & Accessories

Swinging Screen Doors

Swinging screen doors are available for field installation with Kolbe single and double inswing doors. Screen doors feature an adjustable self-closing mechanism. Double swinging screen doors are equipped with spring-loaded locking mechanisms on the head and sill of the passive door. Energy efficiency is provided by weatherstripping around the frame perimeter and on the astragal of double screen doors; rubber door sweeps meet the sill. Swinging screen door frames are available in over 30 colors, plus custom colors.

Keystones & Pediment Heads

Keystones and pediment heads add a classic touch to the exterior of Heritage Series windows or doors. Pine keystones and pediment heads may be ordered unfinished, primed or prefinished with K-Kron II to match your windows or doors. Ask your Kolbe dealer for more details.



Keystone



Pediment Head

Glazing Beads & Muntin Bars

As standard, glazing beads have a beveled profile, but may also be ordered with a square or ovolo profile. Matching muntin bars are available on units with true divided lites (TDL), performance divided lites (PDL) and wood removable grilles. Units ordered with TDL and PDL will have ovolo muntin bars on the interior and beveled muntin bars on the exterior regardless of the profile chosen for the interior. *(See divided lite cross section drawings on pgs. 180-181.)*



Beveled Profile



Ovolo Profile



Square Profile

Product Performance Modifications

Most Kolbe products can be modified to meet even the most strict building code requirements. Depending on the criteria, Kolbe offers high performance and K-Force® impact performance products to improve air, water and structural ratings or sound transmittance ratings. With each level of modification, window and door strength is enhanced. This could be by using additional sash locks, alternate glazing methods or K-Force impact laminated glass. Contact your Kolbe dealer for further details.



Universal Design

To meet the needs of homeowners with physical limitations, Kolbe offers a variety of window and door options that are designed to make independent living possible. From door sills that create a flush surface for easier passage between the interior and exterior, to window and door hardware that provides ease of operation, we have numerous options that will help make living at home far easier. Whether your project is new construction or you are adapting an existing residence for a special need, Kolbe's windows and doors with universal design options will give you the freedom and style you are seeking. Below are some examples.

Casements



Longer crank handles with large knobs for casement windows make operating easier. Available in white or clay.



Larger levers for multi-point casement locks make locking of a casement window easy. Available in white or clay.



Motorized operators make opening and closing casement windows simple and effortless. Available in white or clay.

Double Hungs



A crank handle hardware kit for double hungs allows the bottom sash to be operated with minimal effort. Available in white.

Swinging Doors



Wider door sizes help provide additional space for those who use mobility aids.

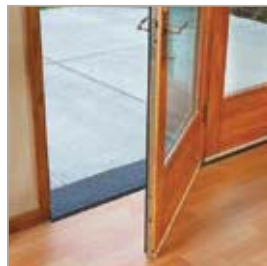

ADA-compliant sills (thermal break and non-thermal break) for swinging doors create a flush surface for easy access to pass through.



Lever handles for swinging doors are available in a variety of styles and finishes and make operation easier than doors with knobs.

Sliding Doors



Aluminum sill ramp kits for Garden-Aire sliding patio doors allow smooth transitioning between the interior and exterior of the home.

Many of these options meet standards of the Americans with Disabilities Act. Other options such as taller bottom rails on doors are also available to meet these standards. Certain product limitations and modifications may apply. Please contact your local Kolbe dealer for more information.





Technical Data

Kolbe windows and doors offer not only superior craftsmanship, but also superior performance. Our windows and doors undergo independent testing to ensure the highest quality products available. With Kolbe's participation in programs such as the Energy Star and WDMA Hallmark Certification programs, you can rest assure that our products are tested to industry standards, allowing them to meet and exceed today's stricter building codes and standards for energy efficiency.



Clear Opening Dimensions

Rough Opening Recommendations:

The Kolbe standard rough opening dimensions published in our product literature are provided as a guideline to maintain a minimum 1/4" space between the window or patio door and the building structure. There are certain situations where Kolbe recommends a gap larger than our published 1/4" standard:

- ▶ When installation clips are used, the gap should be increased to 1/2" on the sides, top and bottom of the unit.
- ▶ When mulls are installed in the opening, the gap all around should be increased to 1/2". For installation consistency, the same gap should be used on all units in the project.
- ▶ If a sill pan drainage system is used, the gap should be increased to 1/2" on the top and bottom of the unit.

Because every installation is different, Kolbe strongly recommends consultation with the local supplier or an experienced contractor, architect or structural engineer prior to the installation of any Kolbe product. Installation of Kolbe products, including sizing of rough opening, method of attachment, fastener selection, and code compliance is the sole responsibility of the architect, building owner, contractor and/or consumer. Unless otherwise specified, if units are ordered by rough opening, Kolbe will size the units using our standard minimum 1/4" gap - regardless of the options or construction of the product ordered.

Definitions of Acceptable Emergency Escape & Rescue Openings:

"Egress" has long been the term used to describe the clear opening dimensions of a window or door necessary to enter or exit a building in case of an emergency. With the release of the International Building Code (IBC) and International Residential Code (IRC), "egress" is no longer the appropriate term.

IBC and IRC have set the following as basic requirements for Emergency Escape & Rescue Openings.

- ▶ Minimum Opening Width: 20 inches (508 mm)
- ▶ Minimum Opening Height: 24 inches (610 mm)
- ▶ Minimum Opening Area: 5.7 sq. ft. (0.53 m²)

NOTE:

Please check your local codes to confirm that these Emergency Escape & Rescue Opening requirements are applicable. Other requirements may also apply.

Note For Casement Windows:

- ▶ Clear opening widths shown are for standard casements with multi-point locks and concealed hinges.

Exposed Hinges (a.k.a. Euro Hinges) - The Euro hinge is the default hinge used when standard concealed casement hinges can not be utilized (radius head units, high performance units and impact performance units), or if this type of hinge is requested.

In most cases single-arm operators are used with Euro hinges, which changes the clear opening widths. For units with this type of hinge, add 3-7/16" to widths shown for one sash open. For French casements add 6-7/8" to widths shown for two sash open. Two sash open may or may not be considered as an acceptable emergency escape and rescue opening per the local building inspector.

- ▶ All dimensions are taken with sash open to 90°, except for an "E" Series unit with dual-arm operator and concealed hinges, which opens to 75°.
- ▶ Shaded units meet most national building codes for emergency escape and rescue requirements.

Product #	Sq. Ft. Clear Opg.	Clear Opening		Sq. Ft. D.L.O.	Sq. Ft. Vent	Sq. Ft. of Unit Frame Dim.
		Width	Height			
Casements						
S12	0.99	7-5/16"	19-1/2"	1.30	1.59	2.67
S126	1.29	7-5/16"	25-1/2"	1.73	2.08	3.33
S13	1.60	7-5/16"	31-1/2"	2.15	2.57	4.00
S136	1.90	7-5/16"	37-1/2"	2.58	3.06	4.67
S14	2.21	7-5/16"	43-1/2"	3.01	3.55	5.33
S146	2.51	7-5/16"	49-1/2"	3.43	4.04	6.00
S15	2.82	7-5/16"	55-1/2"	3.86	4.53	6.67
S156	3.12	7-5/16"	61-1/2"	4.29	5.02	7.33
S16	3.43	7-5/16"	67-1/2"	4.72	5.51	8.00
N12	1.53	11-5/16"	19-1/2"	1.81	2.13	3.33
N126	2.00	11-5/16"	25-1/2"	2.40	2.79	4.17
N13	2.47	11-5/16"	31-1/2"	2.99	3.45	5.00
N136	2.95	11-5/16"	37-1/2"	3.59	4.10	5.83
N14	3.42	11-5/16"	43-1/2"	4.18	4.76	6.67
N146	3.89	11-5/16"	49-1/2"	4.77	5.41	7.50
N15	4.36	11-5/16"	55-1/2"	5.37	6.07	8.33
N156	4.83	11-5/16"	61-1/2"	5.96	6.73	9.17
N16	5.30	11-5/16"	67-1/2"	6.56	7.38	10.00
W12	2.07	15-5/16"	19-1/2"	2.31	2.67	4.00
W126	2.71	15-5/16"	25-1/2"	3.07	3.50	5.00
W13	3.35	15-5/16"	31-1/2"	3.83	4.32	6.00
W136	3.99	15-5/16"	37-1/2"	4.59	5.14	7.00
W14	4.63	15-5/16"	43-1/2"	5.35	5.97	8.00
W146	5.26	15-5/16"	49-1/2"	6.12	6.79	9.00
W15	5.90	15-5/16"	55-1/2"	6.88	7.61	10.00
W156	6.54	15-5/16"	61-1/2"	7.64	8.43	11.00
W16	7.18	15-5/16"	67-1/2"	8.40	9.26	12.00
L12	2.62	19-5/16"	19-1/2"	2.82	3.22	4.67
L126	3.42	19-5/16"	25-1/2"	3.75	4.21	5.83
L13	4.22	19-5/16"	31-1/2"	4.67	5.20	7.00
L136	5.03	19-5/16"	37-1/2"	5.60	6.18	8.17
L14	5.83	19-5/16"	43-1/2"	6.53	7.17	9.33
L146	6.64	19-5/16"	49-1/2"	7.46	8.16	10.50
L15	7.44	19-5/16"	55-1/2"	8.38	9.15	11.67
L156	8.25	19-5/16"	61-1/2"	9.31	10.14	12.83
L16	9.05	19-5/16"	67-1/2"	10.24	11.13	14.00
X12	2.89	21-5/16"	19-1/2"	3.07	3.49	5.00
X126	3.77	21-5/16"	25-1/2"	4.08	4.56	6.25
X13	4.66	21-5/16"	31-1/2"	5.09	5.63	7.50
X136	5.55	21-5/16"	37-1/2"	6.10	6.71	8.75
X14	6.44	21-5/16"	43-1/2"	7.12	7.78	10.00
X146	7.33	21-5/16"	49-1/2"	8.13	8.85	11.25
X15	8.21	21-5/16"	55-1/2"	9.14	9.92	12.50
X156	9.10	21-5/16"	61-1/2"	10.15	11.00	13.75
X16	9.99	21-5/16"	67-1/2"	11.16	12.07	15.00
E13	5.63	25-3/4"	31-1/2"	6.35	6.95	9.00
E136	6.71	25-3/4"	37-1/2"	7.62	8.27	10.50

NOTE: For the most up to date data, please visit the Kolbe website at www.kolbe-kolbe.com.

Product #	Sq. Ft. Clear Opg.	Clear Opening		Sq. Ft. D.L.O.	Sq. Ft. Vent	Sq. Ft. of Unit Frame Dim.
		Width	Height			
Casements (continued)						
E14	7.78	25-3/4"	43-1/2"	8.88	9.59	12.00
E146	8.85	25-3/4"	49-1/2"	10.14	10.91	13.50
E15	9.92	25-3/4"	55-1/2"	11.40	12.24	15.00
E156	11.00	25-3/4"	61-1/2"	12.66	13.56	16.50
E16	12.07	25-3/4"	67-1/2"	13.92	14.88	18.00

Product #	Sq. Ft. Clear Opg.	Clear Opg.		Sq. Ft. D.L.O.	Sq. Ft. Vent	Sq. Ft. of Frame Dim.
		Width	Height			
Push-out Casements						
S12	0.91	6-3/4"	19-1/2"	1.03	1.73	2.67
S126	1.20	6-3/4"	25-1/2"	1.40	2.26	3.33
S13	1.48	6-3/4"	31-1/2"	1.76	2.79	4.00
S136	1.76	6-3/4"	37-1/2"	2.13	3.32	4.67
S14	2.04	6-3/4"	43-1/2"	2.50	3.85	5.33
S146	2.32	6-3/4"	49-1/2"	2.86	4.38	6.00
S15	2.60	6-3/4"	55-1/2"	3.23	4.91	6.67
S156	2.88	6-3/4"	61-1/2"	3.60	5.45	7.33
S16	3.16	6-3/4"	67-1/2"	3.97	5.98	8.00
N12	1.46	10-3/4"	19-1/2"	1.50	2.27	3.33
N126	1.90	10-3/4"	25-1/2"	2.03	2.97	4.17
N13	2.35	10-3/4"	31-1/2"	2.56	3.66	5.00
N136	2.80	10-3/4"	37-1/2"	3.10	4.36	5.83
N14	3.25	10-3/4"	43-1/2"	3.63	5.06	6.67
N146	3.70	10-3/4"	49-1/2"	4.16	5.76	7.50
N15	4.14	10-3/4"	55-1/2"	4.70	6.46	8.33
N156	4.59	10-3/4"	61-1/2"	5.23	7.15	9.17
N16	5.04	10-3/4"	67-1/2"	5.77	7.85	10.00
W12	2.00	10-3/4"	19-1/2"	1.96	2.81	4.00
W126	2.61	14-3/4"	25-1/2"	2.66	3.67	5.00
W13	3.23	14-3/4"	31-1/2"	3.36	4.54	6.00
W136	3.84	14-3/4"	37-1/2"	4.06	5.40	7.00
W14	4.46	14-3/4"	43-1/2"	4.76	6.27	8.00
W146	5.07	14-3/4"	49-1/2"	5.47	7.13	9.00
W15	5.68	14-3/4"	55-1/2"	6.17	8.00	10.00
W156	6.30	14-3/4"	61-1/2"	6.87	8.86	11.00
W16	6.91	14-3/4"	67-1/2"	7.57	9.73	12.00
L12	2.54	18-3/4"	19-1/2"	2.43	3.35	4.67
L126	3.32	18-3/4"	25-1/2"	3.30	4.38	5.83
L13	4.10	18-3/4"	31-1/2"	4.16	5.41	7.00
L136	4.88	18-3/4"	37-1/2"	5.03	6.45	8.17
L14	5.66	18-3/4"	43-1/2"	5.90	7.48	9.33
L146	6.45	18-3/4"	49-1/2"	6.77	8.51	10.50
L15	7.23	18-3/4"	55-1/2"	7.63	9.54	11.67
L156	8.01	18-3/4"	61-1/2"	8.50	10.57	12.83
L16	8.79	18-3/4"	67-1/2"	9.37	11.60	14.00

Product #	Sq. Ft. Clear Opg.	Clear Opg.		Sq. Ft. D.L.O.	Sq. Ft. Vent	Sq. Ft. of Frame Dim.
		Width	Height			
Push-out Casements (continued)						
X12	2.81	20-3/4"	19-1/2"	2.66	3.62	5.00
X126	3.67	20-3/4"	25-1/2"	3.61	4.74	6.25
X13	4.54	20-3/4"	31-1/2"	4.56	5.85	7.50
X136	5.40	20-3/4"	37-1/2"	5.51	6.97	8.75
X14	6.27	20-3/4"	43-1/2"	6.47	8.08	10.00
X146	7.13	20-3/4"	49-1/2"	7.42	9.20	11.25
X15	8.00	20-3/4"	55-1/2"	8.37	10.31	12.50
X156	8.86	20-3/4"	61-1/2"	9.32	11.42	13.75
X16	9.73	20-3/4"	67-1/2"	10.27	12.54	15.00
E13	5.85	26-3/4"	31-1/2"	5.76	7.16	9.00
E136	6.97	26-3/4"	37-1/2"	6.97	8.53	10.50
E14	8.08	26-3/4"	43-1/2"	8.17	9.89	12.00
E146	9.20	26-3/4"	49-1/2"	9.37	11.26	13.50
E15	10.31	26-3/4"	55-1/2"	10.57	12.62	15.00
E156	11.42	26-3/4"	61-1/2"	11.77	13.99	16.50
E16	12.54	26-3/4"	67-1/2"	12.97	15.35	18.00

Product #	Sq. Ft. Clear Opg.		Clear Opg. Width		Clear Opg. Ht.	Sq. Ft. D.L.O.	Sq. Ft. Vent	Sq. Ft. of Unit Frame Dim.
	1 Open	2 Open	1 Open	2 Open				
French Casements								
N23	2.66	5.71	12-3/16"	26-3/16"	31-3/8"	6.35	7.93	10.00
N236	3.16	6.80	12-3/16"	26-3/16"	37-3/8"	7.62	9.44	11.67
N24	3.67	7.89	12-3/16"	26-3/16"	43-3/8"	8.88	10.96	13.33
N246	4.18	8.98	12-3/16"	26-3/16"	49-3/8"	10.14	12.47	15.00
N25	4.69	10.07	12-3/16"	26-3/16"	55-3/8"	11.40	13.99	16.67
N256	5.19	11.16	12-3/16"	26-3/16"	61-3/8"	12.66	15.50	18.33
N26	5.70	12.25	12-3/16"	26-3/16"	67-3/8"	13.92	17.02	20.00
W23	3.53	7.45	16-3/16"	34-3/16"	31-3/8"	8.04	9.67	12.00
W236	4.20	8.87	16-3/16"	34-3/16"	37-3/8"	9.63	11.52	14.00
W24	4.88	10.30	16-3/16"	34-3/16"	43-3/8"	11.22	13.37	16.00
W246	5.55	11.72	16-3/16"	34-3/16"	49-3/8"	12.82	15.22	18.00
W25	6.22	13.15	16-3/16"	34-3/16"	55-3/8"	14.41	17.06	20.00
X23	4.83	10.06	22-3/16"	46-3/16"	31-3/8"	10.56	12.28	15.00
X236	5.76	11.99	22-3/16"	46-3/16"	37-3/8"	12.65	14.63	17.50
X24	6.68	13.91	22-3/16"	46-3/16"	43-3/8"	14.74	16.98	20.00
X246	7.61	15.84	22-3/16"	46-3/16"	49-3/8"	16.84	19.33	22.50
X25	8.53	17.76	22-3/16"	46-3/16"	55-3/8"	18.93	21.68	25.00

NOTE: For the most up to date data, please visit the Kolbe website at www.kolbe-kolbe.com.

Clear Opening Dimensions

Product #	Sq. Ft. Clear Opp.	Clear Opening		Sq. Ft. D.L.O.	Sq. Ft. Vent	Sq. Ft. of Unit Frame Dim.
		Width	Height			
Inswing Casements						
W13	4.42	19-1/2"	32-5/8"	3.67	4.96	6.13
W136	5.23	19-1/2"	38-5/8"	4.46	5.87	7.15
W14	6.04	19-1/2"	44-5/8"	5.24	6.78	8.17
W146	6.86	19-1/2"	50-5/8"	6.03	7.69	9.19
W15	7.67	19-1/2"	56-5/8"	6.81	8.60	10.21
W156	8.48	19-1/2"	62-5/8"	7.59	9.51	11.23
W16	9.29	19-1/2"	68-5/8"	8.38	10.42	12.25

Product #	Sq. Ft. Clear Opp.		Clear Opp. Width		Clear Opp. Ht.	Sq. Ft. D.L.O.	Sq. Ft. Vent	Sq. Ft. of Unit Frame Dim.
	1 Open	2 Open	1 Open	2 Open				
	French Inswing Casements							
N23	3.51	7.17	15-1/2"	31-5/8"	32-5/8"	5.79	8.47	10.00
N236	4.16	8.48	15-1/2"	31-5/8"	38-5/8"	7.02	10.03	11.67
N24	4.80	9.80	15-1/2"	31-5/8"	44-5/8"	8.25	11.58	13.33
N246	5.45	11.12	15-1/2"	31-5/8"	50-5/8"	9.49	13.14	15.00
N25	6.10	12.44	15-1/2"	31-5/8"	56-5/8"	10.72	14.70	16.67
N256	6.74	13.75	15-1/2"	31-5/8"	62-5/8"	11.96	16.25	18.33
N26	7.39	15.07	15-1/2"	31-5/8"	68-5/8"	13.19	17.81	20.00
W23	4.42	8.98	19-1/2"	39-5/8"	32-5/8"	7.35	10.28	12.00
W236	5.23	10.63	19-1/2"	39-5/8"	38-5/8"	8.92	12.17	14.00
W24	6.04	12.28	19-1/2"	39-5/8"	44-5/8"	10.48	14.06	16.00
W246	6.86	13.93	19-1/2"	39-5/8"	50-5/8"	12.05	15.95	18.00
W25	7.67	15.58	19-1/2"	39-5/8"	56-5/8"	13.62	17.84	20.00
W256	8.48	17.23	19-1/2"	39-5/8"	62-5/8"	15.19	19.73	22.00
W26	9.29	18.88	19-1/2"	39-5/8"	68-5/8"	16.75	21.62	24.00
X23	5.78	11.70	25-1/2"	51-5/8"	32-5/8"	9.69	13.00	15.00
X236	6.84	13.85	25-1/2"	51-5/8"	38-5/8"	11.76	15.39	17.50
X24	7.90	16.00	25-1/2"	51-5/8"	44-5/8"	13.83	17.78	20.00
X246	8.96	18.15	25-1/2"	51-5/8"	50-5/8"	15.90	20.17	22.50
X25	10.03	20.30	25-1/2"	51-5/8"	56-5/8"	17.96	22.56	25.00
X256	11.09	22.45	25-1/2"	51-5/8"	62-5/8"	20.03	24.95	27.50
X26	12.15	24.60	25-1/2"	51-5/8"	68-5/8"	22.10	27.34	30.00

Product #	Sq. Ft. Clear Opp.	Clear Opening		Sq. Ft. D.L.O.	Sq. Ft. Vent	Sq. Ft. of Unit Frame Dim.
		Width	Height			
Sterling Double Hungs						
1614	1.54	17-31/32"	12-3/8"	2.71	1.54	5.44
1616	1.79	17-31/32"	14-3/8"	3.13	1.79	6.04
1620	2.29	17-31/32"	18-3/8"	3.96	2.29	7.23
1622	2.54	17-31/32"	20-3/8"	4.38	2.54	7.83
1624	2.79	17-31/32"	22-3/8"	4.79	2.79	8.43
1626	3.04	17-31/32"	24-3/8"	5.21	3.04	9.02
1628	3.29	17-31/32"	26-3/8"	5.63	3.29	9.62
1630	3.54	17-31/32"	28-3/8"	6.04	3.54	10.22
1632	3.79	17-31/32"	30-3/8"	6.46	3.79	10.82
1634	4.04	17-31/32"	32-3/8"	6.88	4.04	11.41
1636	4.29	17-31/32"	34-3/8"	7.29	4.29	12.01
2014	1.89	21-31/32"	12-3/8"	3.43	1.89	6.45
2016	2.19	21-31/32"	14-3/8"	3.96	2.19	7.16
2020	2.80	21-31/32"	18-3/8"	5.01	2.80	8.58
2022	3.11	21-31/32"	20-3/8"	5.54	3.11	9.29
2024	3.41	21-31/32"	22-3/8"	6.07	3.41	9.99
2026	3.72	21-31/32"	24-3/8"	6.60	3.72	10.70
2028	4.02	21-31/32"	26-3/8"	7.13	4.02	11.41
2030	4.33	21-31/32"	28-3/8"	7.65	4.33	12.12
2032	4.63	21-31/32"	30-3/8"	8.18	4.63	12.83
2034	4.94	21-31/32"	32-3/8"	8.71	4.94	13.54
2036	5.24	21-31/32"	34-3/8"	9.24	5.24	14.24
2414	2.23	25-31/32"	12-3/8"	4.15	2.23	7.47
2416	2.59	25-31/32"	14-3/8"	4.79	2.59	8.28
2420	3.31	25-31/32"	18-3/8"	6.07	3.31	9.92
2422	3.67	25-31/32"	20-3/8"	6.71	3.67	10.74
2424	4.04	25-31/32"	22-3/8"	7.35	4.04	11.56
2426	4.40	25-31/32"	24-3/8"	7.99	4.40	12.38
2428	4.76	25-31/32"	26-3/8"	8.63	4.76	13.20
2430	5.12	25-31/32"	28-3/8"	9.26	5.12	14.02
2432	5.48	25-31/32"	30-3/8"	9.90	5.48	14.84
2434	5.84	25-31/32"	32-3/8"	10.54	5.84	15.66
2436	6.20	25-31/32"	34-3/8"	11.18	6.20	16.48
2614	2.40	27-31/32"	12-3/8"	4.51	2.40	7.97
2616	2.79	27-31/32"	14-3/8"	5.21	2.79	8.85
2620	3.57	27-31/32"	18-3/8"	6.60	3.57	10.60
2622	3.96	27-31/32"	20-3/8"	7.29	3.96	11.47
2624	4.35	27-31/32"	22-3/8"	7.99	4.35	12.35
2626	4.73	27-31/32"	24-3/8"	8.68	4.73	13.22
2628	5.12	27-31/32"	26-3/8"	9.38	5.12	14.10
2630	5.51	27-31/32"	28-3/8"	10.07	5.51	14.97
2632	5.90	27-31/32"	30-3/8"	10.76	5.90	15.85
2634	6.29	27-31/32"	32-3/8"	11.46	6.29	16.72
2636	6.68	27-31/32"	34-3/8"	12.15	6.68	17.60
2814	2.58	29-31/32"	12-3/8"	4.88	2.58	8.48
2816	2.99	29-31/32"	14-3/8"	5.63	2.99	9.41
2820	3.82	29-31/32"	18-3/8"	7.13	3.82	11.27

NOTE: For the most up to date data, please visit the Kolbe website at www.kolbe-kolbe.com.

Product #	Sq. Ft. Clear Oppg.	Clear Opening		Sq. Ft. D.L.O.	Sq. Ft. Vent	Sq. Ft. of Unit Frame Dim.
		Width	Height			
Sterling Double Hungs (continued)						
2822	4.24	29-31/32"	20-3/8"	7.88	4.24	12.20
2824	4.66	29-31/32"	22-3/8"	8.63	4.66	13.13
2826	5.07	29-31/32"	24-3/8"	9.38	5.07	14.06
2828	5.49	29-31/32"	26-3/8"	10.13	5.49	14.99
2830	5.91	29-31/32"	28-3/8"	10.88	5.91	15.92
2832	6.32	29-31/32"	30-3/8"	11.63	6.32	16.85
2834	6.74	29-31/32"	32-3/8"	12.38	6.74	17.78
2836	7.15	29-31/32"	34-3/8"	13.13	7.15	18.71
3014	2.75	31-31/32"	12-3/8"	5.24	2.75	8.98
3016	3.19	31-31/32"	14-3/8"	6.04	3.19	9.97
3020	4.08	31-31/32"	18-3/8"	7.65	4.08	11.94
3022	4.52	31-31/32"	20-3/8"	8.46	4.52	12.93
3024	4.97	31-31/32"	22-3/8"	9.26	4.97	13.91
3026	5.41	31-31/32"	24-3/8"	10.07	5.41	14.90
3028	5.86	31-31/32"	26-3/8"	10.88	5.86	15.89
3030	6.30	31-31/32"	28-3/8"	11.68	6.30	16.87
3032	6.74	31-31/32"	30-3/8"	12.49	6.74	17.86
3034	7.19	31-31/32"	32-3/8"	13.29	7.19	18.84
3036	7.63	31-31/32"	34-3/8"	14.10	7.63	19.83
3214	2.92	33-31/32"	12-3/8"	5.60	2.92	9.49
3216	3.39	33-31/32"	14-3/8"	6.46	3.39	10.53
3220	4.33	33-31/32"	18-3/8"	8.18	4.33	12.61
3222	4.81	33-31/32"	20-3/8"	9.04	4.81	13.66
3224	5.28	33-31/32"	22-3/8"	9.90	5.28	14.70
3226	5.75	33-31/32"	24-3/8"	10.76	5.75	15.74
3228	6.22	33-31/32"	26-3/8"	11.63	6.22	16.78
3230	6.69	33-31/32"	28-3/8"	12.49	6.69	17.82
3232	7.17	33-31/32"	30-3/8"	13.35	7.17	18.86
3234	7.64	33-31/32"	32-3/8"	14.21	7.64	19.91
3236	8.11	33-31/32"	34-3/8"	15.07	8.11	20.95
3614	3.26	37-31/32"	12-3/8"	6.32	3.26	10.50
3616	3.79	37-31/32"	14-3/8"	7.29	3.79	11.65
3620	4.84	37-31/32"	18-3/8"	9.24	4.84	13.96
3622	5.37	37-31/32"	20-3/8"	10.21	5.37	15.11
3624	5.90	37-31/32"	22-3/8"	11.18	5.90	16.27
3626	6.43	37-31/32"	24-3/8"	12.15	6.43	17.42
3628	6.95	37-31/32"	26-3/8"	13.13	6.95	18.57
3630	7.48	37-31/32"	28-3/8"	14.10	7.48	19.72
3632	8.01	37-31/32"	30-3/8"	15.07	8.01	20.88
3634	8.54	37-31/32"	32-3/8"	16.04	8.54	22.03
3636	9.06	37-31/32"	34-3/8"	17.01	9.06	23.18
4014	3.61	41-31/32"	12-3/8"	7.04	3.61	11.51
4016	4.19	41-31/32"	14-3/8"	8.13	4.19	12.78
4020	5.36	41-31/32"	18-3/8"	10.29	5.36	15.31
4022	5.94	41-31/32"	20-3/8"	11.38	5.94	16.57
4024	6.52	41-31/32"	22-3/8"	12.46	6.52	17.83
4026	7.10	41-31/32"	24-3/8"	13.54	7.10	19.10

Product #	Sq. Ft. Clear Oppg.	Clear Opening		Sq. Ft. D.L.O.	Sq. Ft. Vent	Sq. Ft. of Unit Frame Dim.
		Width	Height			
Sterling Double Hungs (continued)						
4028	7.69	41-31/32"	26-3/8"	14.63	7.69	20.36
4030	8.27	41-31/32"	28-3/8"	15.71	8.27	21.63
4032	8.85	41-31/32"	30-3/8"	16.79	8.85	22.89
4034	9.44	41-31/32"	32-3/8"	17.88	9.44	24.15
4036	10.02	41-31/32"	34-3/8"	18.96	10.02	25.42
1624/36	2.79	17-31/32"	22-3/8"	6.04	2.79	10.22
2024/36	3.41	21-31/32"	22-3/8"	7.65	3.41	12.12
2424/36	4.04	25-31/32"	22-3/8"	9.26	4.04	14.02
2624/36	4.35	27-31/32"	22-3/8"	10.01	4.35	14.97
2824/36	4.66	29-31/32"	22-3/8"	10.88	4.66	15.92
3024/36	4.97	31-31/32"	22-3/8"	11.68	4.97	16.87
3224/36	5.28	33-31/32"	22-3/8"	12.49	5.28	17.82
3624/36	5.90	37-31/32"	22-3/8"	14.10	5.90	19.72
4024/36	6.52	41-31/32"	22-3/8"	15.71	6.52	21.63

Notes for Sterling Double Hung Windows:

- ▶ For Sterling high performance units, deduct 2-1/8" from the clear opening heights.
- ▶ Shaded units meet most national building codes for emergency escape and rescue requirements.

Product #	Sq. Ft. Clear Oppg.	Clear Opening		Sq. Ft. D.L.O.	Sq. Ft. Vent	Sq. Ft. of Unit Frame Dim.
		Width	Height			
Traditional Double Hungs						
1614	1.70	18-1/4"	13-7/16"	2.71	1.70	5.44
1616	1.96	18-1/4"	15-7/16"	3.13	1.96	6.04
1620	2.46	18-1/4"	19-7/16"	3.96	2.46	7.23
1622	2.72	18-1/4"	21-7/16"	4.38	2.72	7.83
1624	2.97	18-1/4"	23-7/16"	4.79	2.97	8.43
1626	3.22	18-1/4"	25-7/16"	5.21	3.22	9.02
1628	3.48	18-1/4"	27-7/16"	5.63	3.48	9.62
1630	3.73	18-1/4"	29-7/16"	6.04	3.73	10.22
1632	3.98	18-1/4"	31-7/16"	6.46	3.98	10.82
1634	4.24	18-1/4"	33-7/16"	6.88	4.24	11.41
1636	4.49	18-1/4"	35-7/16"	7.29	4.49	12.01
2014	2.08	22-1/4"	13-7/16"	3.43	2.08	6.45
2016	2.39	22-1/4"	15-7/16"	3.96	2.39	7.16
2020	3.00	22-1/4"	19-7/16"	5.01	3.00	8.58
2022	3.31	22-1/4"	21-7/16"	5.54	3.31	9.29
2024	3.62	22-1/4"	23-7/16"	6.07	3.62	9.99
2026	3.93	22-1/4"	25-7/16"	6.60	3.93	10.70
2028	4.24	22-1/4"	27-7/16"	7.13	4.24	11.41
2030	4.55	22-1/4"	29-7/16"	7.65	4.55	12.12
2032	4.86	22-1/4"	31-7/16"	8.18	4.86	12.83
2034	5.17	22-1/4"	33-7/16"	8.71	5.17	13.54
2036	5.48	22-1/4"	35-7/16"	9.24	5.48	14.24
2414	2.45	26-1/4"	13-7/16"	4.15	2.45	7.47

NOTE: For the most up to date data, please visit the Kolbe website at www.kolbe-kolbe.com.

Clear Opening Dimensions

Product #	Sq. Ft. Clear Oppg.	Clear Opening		Sq. Ft. D.L.O.	Sq. Ft. Vent	Sq. Ft. of Unit Frame Dim.
		Width	Height			
Traditional Double Hungs (continued)						
2416	2.81	26-1/4"	15-7/16"	4.79	2.81	8.28
2420	3.54	26-1/4"	19-7/16"	6.07	3.54	9.92
2422	3.91	26-1/4"	21-7/16"	6.71	3.91	10.74
2424	4.27	26-1/4"	23-7/16"	7.35	4.27	11.56
2426	4.64	26-1/4"	25-7/16"	7.99	4.64	12.38
2428	5.00	26-1/4"	27-7/16"	8.63	5.00	13.20
2430	5.37	26-1/4"	29-7/16"	9.26	5.37	14.02
2432	5.73	26-1/4"	31-7/16"	9.90	5.73	14.84
2434	6.10	26-1/4"	33-7/16"	10.54	6.10	15.66
2436	6.46	26-1/4"	35-7/16"	11.18	6.46	16.48
2614	2.64	28-1/4"	13-7/16"	4.51	2.64	7.97
2616	3.03	28-1/4"	15-7/16"	5.21	3.03	8.85
2620	3.81	28-1/4"	19-7/16"	6.60	3.81	10.60
2622	4.21	28-1/4"	21-7/16"	7.29	4.21	11.47
2624	4.60	28-1/4"	23-7/16"	7.99	4.60	12.35
2626	4.99	28-1/4"	25-7/16"	8.68	4.99	13.22
2628	5.38	28-1/4"	27-7/16"	9.38	5.38	14.10
2630	5.77	28-1/4"	29-7/16"	10.07	5.77	14.97
2632	6.17	28-1/4"	31-7/16"	10.76	6.17	15.85
2634	6.56	28-1/4"	33-7/16"	11.46	6.56	16.72
2636	6.95	28-1/4"	35-7/16"	12.15	6.95	17.60
2814	2.82	30-1/4"	13-7/16"	4.88	2.82	8.48
2816	3.24	30-1/4"	15-7/16"	5.63	3.24	9.41
2820	4.08	30-1/4"	19-7/16"	7.13	4.08	11.27
2822	4.50	30-1/4"	21-7/16"	7.88	4.50	12.20
2824	4.92	30-1/4"	23-7/16"	8.63	4.92	13.13
2826	5.34	30-1/4"	25-7/16"	9.38	5.34	14.06
2828	5.76	30-1/4"	27-7/16"	10.13	5.76	14.99
2830	6.18	30-1/4"	29-7/16"	10.88	6.18	15.92
2832	6.60	30-1/4"	31-7/16"	11.63	6.60	16.85
2834	7.02	30-1/4"	33-7/16"	12.38	7.02	17.78
2836	7.44	30-1/4"	35-7/16"	13.13	7.44	18.71
3014	3.01	32-1/4"	13-7/16"	5.24	3.01	8.98
3016	3.46	32-1/4"	15-7/16"	6.04	3.46	9.97
3020	4.35	32-1/4"	19-7/16"	7.65	4.35	11.94
3022	4.80	32-1/4"	21-7/16"	8.46	4.80	12.93
3024	5.25	32-1/4"	23-7/16"	9.26	5.25	13.91
3026	5.70	32-1/4"	25-7/16"	10.07	5.70	14.90
3028	6.14	32-1/4"	27-7/16"	10.88	6.14	15.89
3030	6.59	32-1/4"	29-7/16"	11.68	6.59	16.87
3032	7.04	32-1/4"	31-7/16"	12.49	7.04	17.86
3034	7.49	32-1/4"	33-7/16"	13.29	7.49	18.84
3036	7.94	32-1/4"	35-7/16"	14.10	7.94	19.83
3214	3.20	34-1/4"	13-7/16"	5.60	3.20	9.49
3216	3.67	34-1/4"	15-7/16"	6.46	3.67	10.53
3220	4.62	34-1/4"	19-7/16"	8.18	4.62	12.61

Product #	Sq. Ft. Clear Oppg.	Clear Opening		Sq. Ft. D.L.O.	Sq. Ft. Vent	Sq. Ft. of Unit Frame Dim.
		Width	Height			
Traditional Double Hungs (continued)						
3222	5.10	34-1/4"	21-7/16"	9.04	5.10	13.66
3224	5.57	34-1/4"	23-7/16"	9.90	5.57	14.70
3226	6.05	34-1/4"	25-7/16"	10.76	6.05	15.74
3228	6.53	34-1/4"	27-7/16"	11.63	6.53	16.78
3230	7.00	34-1/4"	29-7/16"	12.49	7.00	17.82
3232	7.48	34-1/4"	31-7/16"	13.35	7.48	18.86
3234	7.95	34-1/4"	33-7/16"	14.21	7.95	19.91
3236	8.43	34-1/4"	35-7/16"	15.07	8.43	20.95
3614	3.57	38-1/4"	13-7/16"	6.32	3.57	10.50
3616	4.10	38-1/4"	15-7/16"	7.29	4.10	11.65
3620	5.16	38-1/4"	19-7/16"	9.24	5.16	13.96
3622	5.69	38-1/4"	21-7/16"	10.21	5.69	15.11
3624	6.23	38-1/4"	23-7/16"	11.18	6.23	16.27
3626	6.76	38-1/4"	25-7/16"	12.15	6.76	17.42
3628	7.29	38-1/4"	27-7/16"	13.13	7.29	18.57
3630	7.82	38-1/4"	29-7/16"	14.10	7.82	19.72
3632	8.35	38-1/4"	31-7/16"	15.07	8.35	20.88
3634	8.88	38-1/4"	33-7/16"	16.04	8.88	22.03
3636	9.41	38-1/4"	35-7/16"	17.01	9.41	23.18
4014	3.94	42-1/4"	13-7/16"	7.04	3.94	11.51
4016	4.53	42-1/4"	15-7/16"	8.13	4.53	12.78
4020	5.70	42-1/4"	19-7/16"	10.29	5.70	15.31
4022	6.29	42-1/4"	21-7/16"	11.38	6.29	16.57
4024	6.88	42-1/4"	23-7/16"	12.46	6.88	17.83
4026	7.46	42-1/4"	25-7/16"	13.54	7.46	19.10
4028	8.05	42-1/4"	27-7/16"	14.63	8.05	20.36
4030	8.64	42-1/4"	29-7/16"	15.71	8.64	21.63
4032	9.22	42-1/4"	31-7/16"	16.79	9.22	22.89
4034	9.81	42-1/4"	33-7/16"	17.88	9.81	24.15
4036	10.40	42-1/4"	35-7/16"	18.96	10.40	25.42
1624/36	2.97	18-1/4"	23-7/16"	6.04	2.97	10.22
2024/36	3.62	22-1/4"	23-7/16"	7.65	3.62	12.12
2424/36	4.27	26-1/4"	23-7/16"	9.26	4.27	14.02
2824/36	4.92	30-1/4"	23-7/16"	10.88	4.92	15.92
3224/36	5.57	34-1/4"	23-7/16"	12.49	5.57	17.82
3624/36	6.23	38-1/4"	23-7/16"	14.10	6.23	19.72
4024/36	6.88	42-1/4"	23-7/16"	15.71	6.88	21.63

Notes for Traditional Double Hung Windows

- ▶ For Traditional single hungs, deduct 1/4" from the clear opening widths.
- ▶ For Traditional double hung high performance units, deduct 1-1/4" from the clear opening heights.
- ▶ Shaded units meet most national building codes for emergency escape and rescue requirements.

NOTE: For the most up to date data, please visit the Kolbe website at www.kolbe-kolbe.com.

Product #	Sq. Ft. Clear Opp.	Clear Opening		Sq. Ft. D.L.O.	Sq. Ft. Vent	Sq. Ft. of Unit Frame Dim.
		Width	Height			
Magnum Double Hungs						
3062	7.56	33-3/8"	32-5/8"	12.92	7.56	20.44
3066	8.02	33-3/8"	34-5/8"	13.71	8.02	21.50
3072	8.95	33-3/8"	38-5/8"	15.30	8.95	23.61
30710	9.88	33-3/8"	42-5/8"	16.88	9.88	25.73
3086	10.81	33-3/8"	46-5/8"	18.47	10.81	27.85
30810	11.27	33-3/8"	48-5/8"	19.26	11.27	28.91
3462	8.47	37-3/8"	32-5/8"	14.73	8.47	22.58
3466	8.99	37-3/8"	34-5/8"	15.63	8.99	23.75
3472	10.02	37-3/8"	38-5/8"	17.44	10.02	26.09
34710	11.06	37-3/8"	42-5/8"	19.25	11.06	28.43
3486	12.10	37-3/8"	46-5/8"	21.06	12.10	30.77
34810	12.62	37-3/8"	48-5/8"	21.96	12.62	31.94
3862	9.37	41-3/8"	32-5/8"	16.54	9.37	24.72
3866	9.95	41-3/8"	34-5/8"	17.55	9.95	26.01
3872	11.10	41-3/8"	38-5/8"	19.58	11.10	28.57
38710	12.25	41-3/8"	42-5/8"	21.61	12.25	31.13
3886	13.40	41-3/8"	46-5/8"	23.64	13.40	33.69
38810	13.97	41-3/8"	48-5/8"	24.66	13.97	34.97
4062	10.28	45-3/8"	32-5/8"	18.34	10.28	26.87
4066	10.91	45-3/8"	34-5/8"	19.47	10.91	28.26
4072	12.17	45-3/8"	38-5/8"	21.72	12.17	31.05
40710	13.43	45-3/8"	42-5/8"	23.98	13.43	33.83
4086	14.69	45-3/8"	46-5/8"	26.23	14.69	36.61
40810	15.32	45-3/8"	48-5/8"	27.36	15.32	38.01
4462	11.19	49-3/8"	32-5/8"	20.15	11.19	29.01
4466	11.87	49-3/8"	34-5/8"	21.39	11.87	30.52
4472	13.24	49-3/8"	38-5/8"	23.87	13.24	33.52
44710	14.62	49-3/8"	42-5/8"	26.34	14.62	36.53
4486	15.99	49-3/8"	46-5/8"	28.82	15.99	39.54
44810	16.67	49-3/8"	48-5/8"	30.06	16.67	41.04
4862	12.09	53-3/8"	32-5/8"	21.96	12.09	31.16
4866	12.83	53-3/8"	34-5/8"	23.31	12.83	32.77
4872	14.32	53-3/8"	38-5/8"	26.01	14.32	36.00
48710	15.80	53-3/8"	42-5/8"	28.71	15.80	39.23
4886	17.28	53-3/8"	46-5/8"	31.41	17.28	42.46
48810	18.02	53-3/8"	48-5/8"	32.75	18.02	44.07

Product #	Sq. Ft. Clear Opp.	Clear Opening		Sq. Ft. D.L.O.	Sq. Ft. Vent	Sq. Ft. of Unit Frame Dim.
		Width	Height			
Old World Classic Double Hungs						
3062	8.01	35"	32-15/16"	14.10	8.01	23.04
3066	8.49	35"	34-15/16"	14.97	8.49	24.24
3072	9.46	35"	38-15/16"	16.70	9.46	26.63
30710	10.44	35"	42-15/16"	18.44	10.44	29.02
3086	11.41	35"	46-15/16"	20.17	11.41	31.41
30810	11.89	35"	48-15/16"	21.04	11.89	32.60
3462	8.92	39"	32-15/16"	15.91	8.92	25.19
3466	9.46	39"	34-15/16"	16.89	9.46	26.49
3472	10.55	39"	38-15/16"	18.85	10.55	29.10
34710	11.63	39"	42-15/16"	20.80	11.63	31.72
3486	12.71	39"	46-15/16"	22.76	12.71	34.33
34810	13.25	39"	48-15/16"	23.73	13.25	35.63
3862	9.84	43"	32-15/16"	17.72	9.84	27.33
3866	10.43	43"	34-15/16"	18.81	10.43	28.75
3872	11.63	43"	38-15/16"	20.99	11.63	31.58
38710	12.82	43"	42-15/16"	23.17	12.82	34.42
3886	14.02	43"	46-15/16"	25.34	14.02	37.25
38810	14.61	43"	48-15/16"	26.43	14.61	38.67
4062	10.75	47"	32-15/16"	19.53	10.75	29.48
4066	11.40	47"	34-15/16"	20.73	11.40	31.00
4072	12.71	47"	38-15/16"	23.13	12.71	34.06
40710	14.01	47"	42-15/16"	25.53	14.01	37.11
4086	15.32	47"	46-15/16"	27.93	15.32	40.17
40810	15.97	47"	48-15/16"	29.13	15.97	41.70
4462	11.67	51"	32-15/16"	21.34	11.67	31.62
4466	12.37	51"	34-15/16"	22.65	12.37	33.26
4472	13.79	51"	38-15/16"	25.27	13.79	36.54
44710	15.21	51"	42-15/16"	27.89	15.21	39.81
4486	16.62	51"	46-15/16"	30.52	16.62	43.09
44810	17.33	51"	48-15/16"	31.83	17.33	44.73
4862	12.58	55"	32-15/16"	23.15	12.58	33.76
4866	13.34	55"	34-15/16"	24.57	13.34	35.51
4872	14.87	55"	38-15/16"	27.42	14.87	39.01
48710	16.40	55"	42-15/16"	30.26	16.40	42.51
4886	17.93	55"	46-15/16"	33.10	17.93	46.01
48810	18.69	55"	48-15/16"	34.53	18.69	47.76

Notes for Majesta Double Hung Windows:

There are no standard sizes for Majesta windows.
 Minimum Frame Size = 42" wide x 67-1/2" high
 Minimum Glass Size = 34-5/8" wide x 28-7/16" (per sash)
 Egress Clearance = 37" wide x 24" high

NOTE: For the most up to date data, please visit the Kolbe website at www.kolbe-kolbe.com.

Clear Opening Dimensions

Product #	Sq. Ft. Clear Opp.	Clear Opening		Sq. Ft. D.L.O.	Sq. Ft. Vent	Sq. Ft. of Unit Frame Dim.
		Width	Height			
Double Sliders						
1616	1.94	15-3/8"	18-1/8"	3.13	1.94	6.10
1620	2.36	15-3/8"	22-1/8"	3.96	2.36	7.17
1624	2.79	15-3/8"	26-1/8"	4.79	2.79	8.24
1628	3.22	15-3/8"	30-1/8"	5.63	3.22	9.31
1632	3.64	15-3/8"	34-1/8"	6.46	3.64	10.38
1636	4.07	15-3/8"	38-1/8"	7.29	4.07	11.45
1640	4.50	15-3/8"	42-1/8"	8.13	4.50	12.52
1644	4.92	15-3/8"	46-1/8"	8.96	4.92	13.59
1648	5.35	15-3/8"	50-1/8"	9.79	5.35	14.65
2016	2.44	19-3/8"	18-1/8"	3.96	2.44	7.37
2020	2.98	19-3/8"	22-1/8"	5.01	2.98	8.66
2024	3.52	19-3/8"	26-1/8"	6.07	3.52	9.95
2028	4.05	19-3/8"	30-1/8"	7.13	4.05	11.24
2032	4.59	19-3/8"	34-1/8"	8.18	4.59	12.53
2036	5.13	19-3/8"	38-1/8"	9.24	5.13	13.82
2040	5.67	19-3/8"	42-1/8"	10.29	5.67	15.12
2044	6.21	19-3/8"	46-1/8"	11.35	6.21	16.41
2048	6.74	19-3/8"	50-1/8"	12.40	6.74	17.70
2416	2.94	23-3/8"	18-1/8"	4.79	2.94	8.63
2420	3.59	23-3/8"	22-1/8"	6.07	3.59	10.15
2424	4.24	23-3/8"	26-1/8"	7.35	4.24	11.66
2428	4.89	23-3/8"	30-1/8"	8.63	4.89	13.18
2432	5.54	23-3/8"	34-1/8"	9.90	5.54	14.69
2436	6.19	23-3/8"	38-1/8"	11.18	6.19	16.20
2440	6.84	23-3/8"	42-1/8"	12.46	6.84	17.72
2444	7.49	23-3/8"	46-1/8"	13.74	7.49	19.23
2448	8.14	23-3/8"	50-1/8"	15.01	8.14	20.74
2816	3.45	27-3/8"	18-1/8"	5.63	3.45	9.90
2820	4.21	27-3/8"	22-1/8"	7.13	4.21	11.64
2824	4.97	27-3/8"	26-1/8"	8.63	4.97	13.37
2828	5.73	27-3/8"	30-1/8"	10.13	5.73	15.11
2832	6.49	27-3/8"	34-1/8"	11.63	6.49	16.85
2836	7.25	27-3/8"	38-1/8"	13.13	7.25	18.58
2840	8.01	27-3/8"	42-1/8"	14.63	8.01	20.32
2844	8.77	27-3/8"	46-1/8"	16.13	8.77	22.05
2848	9.53	27-3/8"	50-1/8"	17.63	9.53	23.79
3216	3.95	31-3/8"	18-1/8"	6.46	3.95	11.17
3220	4.82	31-3/8"	22-1/8"	8.18	4.82	13.13
3224	5.69	31-3/8"	26-1/8"	9.90	5.69	15.09
3228	6.56	31-3/8"	30-1/8"	11.63	6.56	17.04
3232	7.44	31-3/8"	34-1/8"	13.35	7.44	19.00
3236	8.31	31-3/8"	38-1/8"	15.07	8.31	20.96
3240	9.18	31-3/8"	42-1/8"	16.79	9.18	22.92
3244	10.05	31-3/8"	46-1/8"	18.51	10.05	24.88
3248	10.92	31-3/8"	50-1/8"	20.24	10.92	26.84

Product #	Sq. Ft. Clear Opp.	Clear Opening		Sq. Ft. D.L.O.	Sq. Ft. Vent	Sq. Ft. of Unit Frame Dim.
		Width	Height			
Double Sliders, remodeling sizes						
2020	1.03	7-7/8"	18-3/4"	1.63	1.03	3.82
3020	1.81	13-7/8"	18-3/4"	2.93	1.81	5.78
3030	2.96	13-7/8"	30-3/4"	5.18	2.96	8.74
3040	4.12	13-7/8"	42-3/4"	7.43	4.12	11.69
4040	5.90	19-7/8"	42-3/4"	10.73	5.90	15.65
4050	7.56	19-7/8"	54-3/4"	13.98	7.56	19.61
5030	5.53	25-7/8"	30-3/4"	9.78	5.53	14.64
5040	7.68	25-7/8"	42-3/4"	14.03	7.68	19.60
5050	9.84	25-7/8"	54-3/4"	18.28	9.84	24.56
6030	6.81	31-7/8"	30-3/4"	12.09	6.81	17.60
6040	9.46	31-7/8"	42-3/4"	17.34	9.46	23.55
6050	12.12	31-7/8"	54-3/4"	22.59	12.12	29.51

Product #	Sq. Ft. Clear Opp.	Clear Opening		Sq. Ft. D.L.O.	Sq. Ft. Vent	Sq. Ft. of Unit Frame Dim.
		Width	Height			
Triple Sliders						
163232	4.13	17-7/16"	34-1/8"	13.02	6.78	19.27
163240	5.10	17-7/16"	42-1/8"	16.39	8.37	23.24
163244	5.59	17-7/16"	46-1/8"	18.07	9.17	25.23
163248	6.07	17-7/16"	50-1/8"	19.75	9.96	27.22
204032	5.08	21-7/16"	34-1/8"	16.47	8.68	23.58
204040	6.27	21-7/16"	42-1/8"	20.72	10.71	28.44
204044	6.87	21-7/16"	46-1/8"	22.84	11.73	30.88
204048	7.46	21-7/16"	50-1/8"	24.97	12.75	33.31
204832	5.08	21-7/16"	34-1/8"	18.19	9.67	25.74
204840	6.27	21-7/16"	42-1/8"	22.89	11.94	31.05
204844	6.87	21-7/16"	46-1/8"	25.23	13.07	33.70
204848	7.46	21-7/16"	50-1/8"	27.58	14.21	36.35
244832	6.03	25-7/16"	34-1/8"	19.91	10.58	27.90
244840	7.44	25-7/16"	42-1/8"	25.05	13.05	33.65
244844	8.15	25-7/16"	46-1/8"	27.62	14.29	36.52
244848	8.85	25-7/16"	50-1/8"	30.19	15.53	39.40
Triple Sliders, remodeling sizes						
8040	6.36	21-7/16"	42-3/4"	23.32	12.12	31.54
8050	8.15	21-7/16"	54-3/4"	30.38	15.52	39.52

Notes for Slider Windows:

- ▶ For units with high performance sills, deduct 3/8" from the clear opening heights.
- ▶ Shaded units meet most national building codes for emergency escape and rescue requirements.

Notes for Tilt-Turn Windows:

- ▶ There are no standard sizes for tilt-turn windows.
- ▶ To calculate the clear opening dimension, use the following formula:

Finished Frame Width minus 1.25" = Basic Frame Width
 Finished Frame Height minus 1.65" = Basic Frame Height

Basic Frame Width minus 6.5" = Clear Opening Width
 Basic Frame Height minus 6.1875" = Clear Opening Height

Clear Opening Width x Clear Opening Height ÷ 144 = Sq. Ft. of Clear Opening

NOTE: For the most up to date data, please visit the Kolbe website at www.kolbe-kolbe.com.

Product #	Sq. Ft. Clear Opg.	Clear Opening		Sq. Ft. D.L.O.	Sq. Ft. Vent	Sq. Ft. of Unit Frame Dim
		Width	Height			
Garden-Aire Sliding Patio Doors						
2968	-	-	-	12.46	-	18.61
3368	-	-	-	15.55	-	22.04
3668	-	-	-	17.09	-	23.76
4368	-	-	-	21.71	-	28.91
2980	-	-	-	15.16	-	22.22
3380	-	-	-	18.91	-	26.32
3680	-	-	-	20.78	-	28.37
4380	-	-	-	26.41	-	34.52
5068	12.01	22"	78-5/8"	24.92	12.01	34.35
6068	15.29	28"	78-5/8"	31.09	15.29	41.22
6668	16.93	31"	78-5/8"	34.17	16.93	44.65
8068	21.84	40"	78-5/8"	43.42	21.84	54.96
5080	14.46	22"	94-5/8"	30.31	14.46	41.02
6080	18.40	28"	94-5/8"	37.81	18.40	49.22
6680	20.37	31"	94-5/8"	41.56	20.37	53.32
8080	26.28	40"	94-5/8"	52.81	26.28	65.63
7968	12.01	22"	78-5/8"	37.39	12.01	52.95
9368	15.29	28"	78-5/8"	46.64	15.29	63.26
10068	16.93	31"	78-5/8"	51.26	16.93	68.41
12368	21.84	40"	78-5/8"	65.14	21.84	83.87
7980	14.46	22"	94-5/8"	45.47	14.46	63.23
9380	18.40	28"	94-5/8"	56.72	18.40	75.54
10080	20.37	31"	94-5/8"	62.34	20.37	81.69
12380	26.8	40"	94-5/8"	79.22	26.28	100.15
Garden-Aire Sliding Patio Doors, remodeling sizes						
2866	-	-	-	10.72	-	17.76
3266	-	-	-	14.77	-	21.09
4266	-	-	-	20.73	-	27.76
41166	11.37	21-1/2"	76-1/8"	23.59	11.37	32.75
51166	14.54	27-1/2"	76-1/8"	29.54	14.54	39.41
71166	20.88	39-1/2"	76-1/8"	41.46	20.88	52.74
7766	11.37	21-1/2"	76-1/8"	35.38	11.37	50.52
9166	14.54	27-1/2"	76-1/8"	44.32	14.54	60.51
12166	20.88	39-1/2"	76-1/8"	62.19	20.88	80.49
2968	-	-	-	9.84	-	18.61
3368	-	-	-	12.65	-	22.04
3668	-	-	-	14.06	-	23.76
4368	-	-	-	18.27	-	28.91
2980	-	-	-	12.17	-	22.22
3380	-	-	-	15.65	-	26.32
3680	-	-	-	17.39	-	28.37
4380	-	-	-	22.61	-	34.52
5068	12.01	22"	78-5/8"	19.68	12.01	34.35
6068	15.29	28"	78-5/8"	25.30	15.29	41.22
6668	16.93	31"	78-5/8"	28.11	16.93	44.65
8068	21.84	40"	78-5/8"	36.55	21.84	54.96

Product #	Sq. Ft. Clear Opg.	Clear Opening		Sq. Ft. D.L.O.	Sq. Ft. Vent	Sq. Ft. of Unit Frame Dim
		Width	Height			
Garden-Aire Sliding Patio Doors - wide stile (continued)						
5080	14.46	22"	94-5/8"	24.35	14.46	41.02
6080	18.40	28"	94-5/8"	31.30	18.40	49.22
6680	20.37	31"	94-5/8"	34.78	20.37	53.32
8080	26.28	40"	94-5/8"	45.21	26.28	65.63
7968	12.01	22"	78-5/8"	29.52	12.01	52.95
9368	15.29	28"	78-5/8"	37.95	15.29	63.26
10068	16.93	31"	78-5/8"	42.17	16.93	68.41
12368	21.84	40"	78-5/8"	54.82	21.84	83.87
7980	14.46	22"	94-5/8"	36.52	14.46	63.23
9380	18.40	28"	94-5/8"	46.95	18.40	75.54
10080	20.37	31"	94-5/8"	52.17	20.37	81.69
12380	26.28	40"	94-5/8"	67.82	26.28	100.15
Garden-Aire Sliding Patio Doors - wide stile, remodeling sizes						
2866	-	-	-	9.25	-	17.76
3266	-	-	-	11.96	-	21.09
4266	-	-	-	17.37	-	27.76
41166	11.37	21-1/2"	76-1/8"	18.50	11.37	32.75
51166	14.54	27-1/2"	76-1/8"	23.91	14.54	39.41
71166	20.88	39-1/2"	76-1/8"	34.74	20.88	52.74
7666	11.37	21-1/2"	76-1/8"	27.75	11.37	50.52
9166	14.54	27-1/2"	76-1/8"	35.87	14.54	60.51
12166	20.88	39-1/2"	76-1/8"	52.11	20.88	80.49

Product #	Sq. Ft. Clear Opg.		Clear Opg. Width		Clear Opg. Ht.	Sq. Ft. D.L.O.	Sq. Ft. Vent	Sq. Ft. of Unit Frame Dim.
	1 Open	2 Open	1 Open	2 Open				
Garden-Aire Sliding Patio Doors - 4-wide								
4-10068	12.32	24.78	22-9/16"	45-3/8"	78-5/8"	49.85	24.78	67.75
4-12068	15.60	31.33	28-9/16"	57-3/8"	78-5/8"	62.18	31.33	81.49
4-16068	22.15	44.43	40-9/16"	81-3/8"	78-5/8"	86.85	44.43	108.97
4-10080	14.83	29.82	22-9/16"	45-3/8"	94-5/8"	60.63	29.82	80.90
4-12080	18.77	37.70	28-9/16"	57-3/8"	94-5/8"	75.63	37.70	97.31
4-16080	26.65	53.47	40-9/16"	81-3/8"	94-5/8"	105.63	53.47	130.12
Garden-Aire Sliding Patio Doors - 4-wide, wide stile								
4-10068	12.32	24.78	22-9/16"	45-3/8"	78-5/8"	39.36	24.78	67.75
4-12068	15.60	31.33	28-9/16"	57-3/8"	78-5/8"	50.60	31.33	81.49
4-16068	22.15	44.43	40-9/16"	81-3/8"	78-5/8"	73.09	44.43	108.97
4-10080	14.83	29.82	22-9/16"	45-3/8"	94-5/8"	48.69	29.82	80.90
4-12080	18.77	37.70	28-9/16"	57-3/8"	94-5/8"	62.60	37.70	97.31
4-16080	26.65	53.47	40-9/16"	81-3/8"	94-5/8"	90.42	53.47	130.12

NOTE: For the most up to date data, please visit the Kolbe website at www.kolbe-kolbe.com.

Clear Opening Dimensions

Product #	Sq. Ft. Clear Oppg.		Clear Oppg. Width		Clear Opt. Ht.	Sq. Ft. D.L.O.	Sq. Ft. Vent	Sq. Ft. of Unit Frame Dim.
	1 Open	2 Open	1 Open	2 Open				
Inswing Patio Doors - 1-wide								
2666	13.65	-	25-3/4"	-	76-11/32"	8.68	14.65	16.70
3066	16.83	-	31-3/4"	-	76-11/32"	11.37	17.83	20.01
2680	16.53	-	25-3/4"	-	92-7/16"	10.83	17.73	20.08
3080	20.38	-	31-3/4"	-	92-7/16"	14.20	21.58	24.06
Inswing Patio Doors - 2-wide (stationary/active)								
41166	13.65	-	25-3/4"	-	76-11/32"	17.35	14.62	32.81
51166	16.83	-	31-3/4"	-	76-11/32"	22.74	17.80	39.44
41180	16.53	-	25-3/4"	-	92-7/16"	21.67	17.70	39.46
51180	20.38	-	31-3/4"	-	92-7/16"	28.40	21.55	47.42
Inswing Patio Doors - French								
41166	13.65	26.64	25-3/4"	50-1/4"	76-11/32"	17.35	30.12	32.81
51166	16.83	33.00	31-3/4"	62-1/4"	76-11/32"	22.74	36.48	39.44
41180	16.53	32.26	25-3/4"	50-1/4"	92-7/16"	21.67	36.47	39.46
51180	20.38	39.96	31-3/4"	62-1/4"	92-7/16"	28.40	44.17	47.42
Inswing Patio Doors - 3-wide (stationary/active/stationary)								
7566	13.65	-	25-3/4"	-	76-11/32"	26.03	14.62	48.93
81166	16.83	-	31-3/4"	-	76-11/32"	34.11	17.80	58.87
7580	16.53	-	25-3/4"	-	92-7/16"	32.50	17.70	58.83
81180	20.38	-	31-3/4"	-	92-7/16"	42.60	21.55	70.78

Notes for Inswing Patio Doors:

- ▶ For units with ADA-compliant sills, add 5/8" to the clear opening heights.
- ▶ One or both sash open to 90°

Product #	Sq. Ft. Clear Oppg.		Clear Oppg. Width		Clear Oppg. Ht.	Sq. Ft. D.L.O.	Sq. Ft. Vent	Sq. Ft. of Unit Frame Dim.
	1 Open	2 Open	1 Open	2 Open				
Outswing Doors - patio sizes, 1-wide								
2666	13.60	-	25-27/32"	-	75-25/32"	8.68	14.59	17.00
3066	16.76	-	31-27/32"	-	75-25/32"	11.37	17.74	20.31
2680	16.49	-	25-27/32"	-	91-7/8"	10.83	17.69	20.45
3080	20.32	-	31-27/32"	-	91-7/8"	14.20	21.51	24.43
Outswing Doors - patio sizes, 2-wide (stationary/active)								
41166	13.60	-	25-27/32"	-	75-25/32"	17.35	14.57	33.14
51166	16.76	-	31-27/32"	-	75-25/32"	22.74	17.73	39.76
41180	16.49	-	25-27/32"	-	91-7/8"	21.67	17.67	39.86
51180	20.32	-	31-27/32"	-	91-7/8"	28.40	21.49	47.82
Outswing Doors - patio sizes, French units								
41166	13.60	27.13	25-27/32"	51-9/16"	75-25/32"	17.35	30.00	33.14
51166	16.76	33.45	31-27/32"	63-9/16"	75-25/32"	22.74	36.31	39.76
41180	16.49	32.90	25-27/32"	51-9/16"	91-7/8"	21.67	36.37	39.86
51180	20.32	40.55	31-27/32"	63-9/16"	91-7/8"	28.40	44.02	47.82
Outswing Doors - patio sizes, 3-wide (stationary/active/stationary)								
7566	13.60	-	25-27/32"	-	75-25/32"	26.03	14.57	49.26
81166	16.76	-	31-27/32"	-	75-25/32"	34.11	17.73	59.19
7580	16.49	-	25-27/32"	-	91-7/8"	32.50	17.66	59.25
81180	20.32	-	31-27/32"	-	91-7/8"	42.60	21.49	71.19

Notes for Outswing Patio Doors:

- ▶ For units with ADA-compliant sills, add 1-1/8" to the clear opening heights.
- ▶ One or both sash open to 90°.

NOTE: For the most up to date data, please visit the Kolbe website at www.kolbe-kolbe.com.

Product #	Sq. Ft. Clear Opg.		Clear Opg. Width		Clear Opg. Ht.	Sq. Ft. D.L.O.	Sq. Ft. Vent	Sq. Ft. of Unit Frame Dim.
	1 Open	2 Open	1 Open	2 Open				
Inswing Entrance Doors - 1-wide								
2068	11.67	-	21-1/8"	-	79-9/16"	6.93	12.71	14.72
2668	14.99	-	27-1/8"	-	79-9/16"	9.76	16.02	18.17
2868	16.09	-	29-1/8"	-	79-9/16"	10.70	17.13	19.32
3068	18.30	-	33-1/8"	-	79-9/16"	12.59	19.34	21.61
2070	12.26	-	21-1/8"	-	83-9/16"	7.33	13.35	15.43
2670	15.74	-	27-1/8"	-	83-9/16"	10.33	16.83	19.05
2870	16.90	-	29-1/8"	-	83-9/16"	11.33	17.99	20.25
3070	19.22	-	33-1/8"	-	83-9/16"	13.33	20.31	22.66
2080	14.02	-	21-1/8"	-	95-9/16"	8.56	15.26	17.57
2680	18.00	-	27-1/8"	-	95-9/16"	12.05	19.25	21.68
2880	19.33	-	29-1/8"	-	95-9/16"	13.22	20.57	23.05
3080	21.98	-	33-1/8"	-	95-9/16"	15.55	23.23	25.79
Inswing Entrance Doors - 2-wide (stationary/active)								
4068	11.67	-	21-1/8"	-	79-9/16"	13.85	12.68	28.83
5068	14.99	-	27-1/8"	-	79-9/16"	19.51	16.00	35.72
5468	16.09	-	29-1/8"	-	79-9/16"	21.40	17.10	38.02
6068	18.30	-	33-1/8"	-	79-9/16"	25.17	19.31	42.62
4070	12.26	-	21-1/8"	-	83-9/16"	14.67	13.32	30.22
5070	15.74	-	27-1/8"	-	83-9/16"	20.66	16.80	37.45
5470	16.90	-	29-1/8"	-	83-9/16"	22.66	17.96	39.86
6070	19.22	-	33-1/8"	-	83-9/16"	26.65	20.28	44.68
4080	14.02	-	21-1/8"	-	95-9/16"	17.12	15.23	34.41
5080	18.00	-	27-1/8"	-	95-9/16"	24.11	19.21	42.63
5480	19.33	-	29-1/8"	-	95-9/16"	26.44	20.54	45.38
6080	21.98	-	33-1/8"	-	95-9/16"	31.10	23.30	50.86
Inswing Entrance Doors - French								
4068	11.67	22.65	21-1/8"	41"	79-9/16"	13.85	26.28	28.83
5068	14.99	29.28	27-1/8"	53"	79-9/16"	19.51	32.91	35.72
5468	16.09	31.49	29-1/8"	57"	79-9/16"	21.40	35.12	38.02
6068	18.30	35.91	33-1/8"	65"	79-9/16"	25.71	39.54	42.62
4070	12.26	23.79	21-1/8"	41"	83-9/16"	14.67	27.60	30.22
5070	15.74	30.76	27-1/8"	53"	83-9/16"	20.66	34.56	37.45
5470	16.90	33.08	29-1/8"	57"	83-9/16"	22.66	36.89	39.86
6070	19.22	37.72	33-1/8"	65"	83-9/16"	26.65	41.53	44.68
4080	14.02	27.21	21-1/8"	41"	95-9/16"	17.12	31.56	34.41
5080	18.00	35.17	27-1/8"	53"	95-9/16"	24.11	39.53	42.63
5480	19.33	37.83	29-1/8"	57"	95-9/16"	26.44	42.18	45.38
6080	21.98	43.14	33-1/8"	65"	95-9/16"	31.10	47.49	50.86

Notes for Inswing Entrance Doors:

- ▶ For units with optional oak or ADA-compliant sills, add 5/8" to the clear opening heights.
- ▶ One or both sash open to 90°.

Product #	Sq. Ft. Clear Opg.		Clear Opg. Width		Clear Opg. Ht.	Sq. Ft. D.L.O.	Sq. Ft. Vent	Sq. Ft. of Unit Frame Dim.
	1 Open	2 Open	1 Open	2 Open				
Outswing Entrance Doors - 1-wide								
2068	11.64	-	21-7/32"	-	79"	6.93	12.67	15.04
2668	14.93	-	27-7/32"	-	79"	9.76	15.96	18.48
2868	16.03	-	29-7/32"	-	79"	10.70	17.06	19.63
3068	18.22	-	33-7/32"	-	79"	12.59	19.25	21.92
2070	12.23	-	21-7/32"	-	83"	7.33	13.31	15.77
2670	15.69	-	27-7/32"	-	83"	10.33	16.77	19.37
2870	16.84	-	29-7/32"	-	83"	11.33	17.92	20.58
3070	19.15	-	33-7/32"	-	83"	13.33	20.23	22.98
2080	14.00	-	21-7/32"	-	95"	8.56	15.24	17.95
2680	17.96	-	27-7/32"	-	95"	12.05	19.19	22.06
2880	19.28	-	29-7/32"	-	95"	13.22	20.51	23.43
3080	21.92	-	33-7/32"	-	95"	15.55	23.15	26.17
Outswing Entrance Doors - 2-wide (stationary/active)								
4068	11.64	-	21-7/32"	-	79"	13.85	12.65	29.18
5068	14.93	-	27-7/32"	-	79"	19.51	15.94	36.06
5468	16.03	-	29-7/32"	-	79"	21.40	17.04	38.36
6068	18.22	-	33-7/32"	-	79"	25.17	19.24	42.95
4070	12.23	-	21-7/32"	-	83"	14.67	13.29	30.59
5070	15.69	-	27-7/32"	-	83"	20.66	16.75	37.81
5470	16.84	-	29-7/32"	-	83"	22.66	17.90	40.22
6070	19.15	-	33-7/32"	-	83"	26.65	20.21	45.03
4080	14.00	-	21-7/32"	-	95"	17.12	15.21	34.83
5080	17.96	-	27-7/32"	-	95"	24.11	19.17	43.05
5480	19.28	-	29-7/32"	-	95"	26.44	20.49	45.79
6080	21.91	-	33-7/32"	-	95"	31.10	23.13	51.27
Outswing Entrance Doors - French								
4068	11.64	23.21	21-7/32"	42-5/16"	79"	13.85	26.20	29.18
5068	14.93	29.80	27-7/32"	54-5/16"	79"	19.51	32.78	36.06
5468	16.03	31.99	29-7/32"	58-5/16"	79"	21.40	34.97	38.36
6068	18.22	36.38	33-7/32"	66-5/16"	79"	25.17	39.36	42.95
4070	12.23	24.39	21-7/32"	42-5/16"	83"	14.67	27.52	30.59
5070	15.69	31.30	27-7/32"	54-5/16"	83"	20.66	34.44	37.81
5470	16.84	33.61	29-7/32"	58-5/16"	83"	22.66	36.74	40.22
6070	19.15	38.22	33-7/32"	66-5/16"	83"	26.65	41.36	45.03
4080	14.00	27.91	21-7/32"	42-5/16"	95"	17.12	31.50	34.53
5080	17.96	35.83	27-7/32"	54-5/16"	95"	24.11	39.42	43.05
5480	19.28	38.47	29-7/32"	58-5/16"	95"	26.44	42.06	45.79
6080	21.91	43.75	33-7/32"	66-5/16"	95"	31.10	47.34	51.27

Notes for Outswing Entrance Doors:

- ▶ For units with ADA-compliant sills, add 1-1/8" to the clear opening heights.
- ▶ One or both sash open to 90°.

NOTE: For the most up to date data, please visit the Kolbe website at www.kolbe-kolbe.com.

Energy Performance Data

ENERGY STAR® - United States



ENERGY STAR is a government-regulated program that was created by the Environmental Protection Agency (EPA), and the U.S. Department of Energy (DOE), to help consumers quickly and easily identify energy saving products. The ENERGY STAR program

uses energy values obtained by window and door manufacturers through the National Fenestration Rating Council (NFRC) program. NFRC ratings are based on the energy performance of the total window or door – both glass and frame.

The ENERGY STAR program for the United States divides the nation into four separate climate zones – Northern, North-Central, South-Central, and Southern.

The performance criteria that needs to be met in order to be ENERGY STAR compliant in a specific climate zone (effective January 1, 2015) is shown in the charts provided.

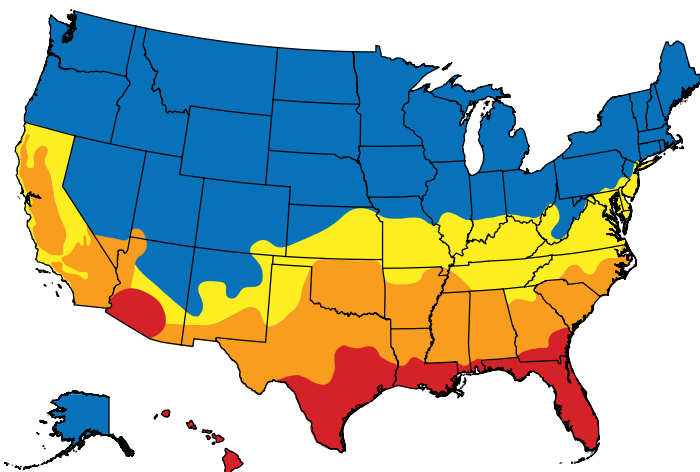

- Northern
Mostly Heating
- North-Central
Heating & Cooling
- South-Central
Heating & Cooling
- Southern
Mostly Cooling

Kolbe demonstrates a commitment to providing accurate energy data by having products independently simulated, tested, inspected and listed in the NFRC certification program, and making that data available on our website and window labels.

NOTE: Energy performance data and air, water, structural data is updated on a continuous basis. For the most current information, visit www.kolbe-kolbe.com or contact your local Kolbe dealer.

Energy Performance Terminology

- ▶ U-Factor refers to a measure of heat transfer through the window or door unit. A lower U-factor means less heat escapes during winter weather, thus reducing heating costs in cold climates.
- ▶ R-Value refers to resistance to heat flow. A high R-value indicates that a window or door has good heat insulating properties.
- ▶ Solar Heat Gain Coefficient (SHGC) is a measure of how much solar energy is passing through the unit's glass. The lower a window or door unit's SHGC, the less solar heat is transmitted into a room, thus allowing for lower cooling bills in hot climates.
- ▶ Visible Transmittance (VT) is a measure of the portion of visible light that passes through a window or door. The higher a window or door unit's VT Total, the more visible light is transmitted into a room. This value is influenced by both the glass selection and by the ratio of glazing and frame area.

2015 ENERGY STAR Qualification Criteria for Windows

Climate Zones - U.S.		U-Factor	SHGC
	Northern**	≤ 0.30	Any
	Northern**	= 0.31	≥ 0.35
	Northern**	= 0.32	≥ 0.40
	North-Central	≤ 0.30	≤ 0.40
	South-Central	≤ 0.30	≤ 0.25
	Southern	≤ 0.40	≤ 0.25

** Northern zone windows can meet prescriptive (1st row) or alternative energy performance (2nd & 3rd row) criteria to qualify for ENERGY STAR.

2016 ENERGY STAR Qualification Criteria for Windows

The effective date for the Northern Zone prescriptive and equivalent energy performance criteria for windows is January 1, 2016. North-Central, South-Central, and Southern criteria will continue to follow 2015 guidelines.

Climate Zones - U.S.		U-Factor	SHGC
	Northern**	≤ 0.27	Any
	Northern**	= 0.28	≥ 0.32
	Northern**	= 0.29	≥ 0.37
	Northern**	= 0.30	≥ 0.42

** Northern zone windows can meet prescriptive (1st row) or alternative energy performance (2nd, 3rd, and 4th rows) criteria to qualify for ENERGY STAR.

2015 ENERGY STAR Qualification Criteria for Doors

Glazing	U-Factor	SHGC	
Opaque	≤ 0.17	No rating	
≤ 1/2-Lite	≤ 0.25	≤ 0.25	
> 1/2-Lite	≤ 0.30	Northern North-Central	≤ 0.40
		Southern South-Central	≤ 0.25

ENERGY STAR® – Canada

Products may comply for Canada's ENERGY STAR program based on these compliance paths: their total U-factor, their Energy Rating (ER), or both. The Energy Rating is based on a product's overall performance based on three criteria: (1) solar heat gain, (2) U-factor, and (3) average air tightness. The higher the ER number, the better the product's thermal performance.



The U-factor and ER criteria for Canada's three climate zones is shown in the charts provided. For more detailed information about their Energy Rating system and Kolbe products that qualify for Canada's ENERGY STAR Program, visit their website at www.oee.nrcan.gc.ca/energystar.

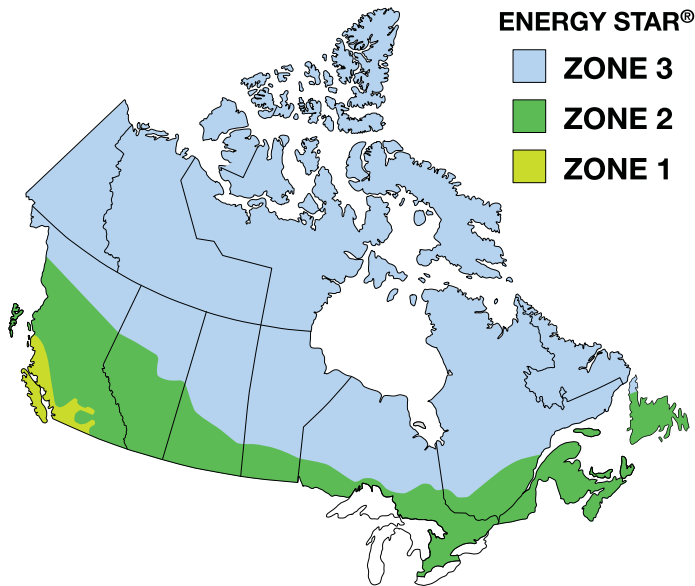

ENERGY STAR - Canada Qualification Criteria for Windows and Sliding Doors† after February 1, 2015

Zone	COMPLIANCE PATHS		
	Minimum Energy Rating (ER)	or	Maximum U-Factor / Minimum ER
1	25	or	≤ 0.28 / 16
2	29	or	≤ 0.25 / 20
3	34	or	≤ 0.21 / 24

† Windows and sliding doors can qualify based on either a combination of the U-factor & a minimum Energy Rating, or just the Energy Rating.

ENERGY STAR - Canada Qualification Criteria for Swinging Doors after February 1, 2015

Zone	COMPLIANCE PATHS		
	Minimum Energy Rating (ER)	or	Maximum U-Factor
1	25	or	≤ 0.28
2	29	or	≤ 0.25
3	34	or	≤ 0.21

U-FACTOR EQUIVALENCY	
Imperial	Metric
0.35	2.00
0.32	1.80
0.28	1.60
0.25	1.40
0.21	1.20

NOTE: Energy performance data and air, water, structural data is updated on a continuous basis. For the most current information, visit www.kolbe-kolbe.com or contact your local Kolbe dealer.



For professionals: www.kolbe-kolbe.com
For homeowners: www.kolbewindows.com

KOLBE
WINDOWS & DOORS

1323 S. 11th Avenue | Wausau, WI 54401-5998
715.842.5666