

CERTIFIED SURVEY MAP NO. _____

ALL OR PART OF LOTS 1 THROUGH 16 AND VACATED ALLEYS ADJACENT IN BLOCK 80 AND ALL OR PART OF LOTS 1 THROUGH 16 AND VACATED ALLEYS ADJACENT IN BLOCK 81 OF PART OF THE EAST HALF OF THE SOUTHWEST 1/4 OF SECTION 29, ALL OR PART OF LOTS 7, 10, 17 AND 18 IN BLOCK 81 AND ALL OR PART OF LOTS 1 THROUGH 13, 25 AND 26 IN BLOCK 246 OF JAMES KNEELAND'S SUBDIVISION, AND VACATED PORTIONS OF WEST CLYBOURN STREET, NORTH 8TH STREET AND NORTH 9TH STREET ADJACENT, ALL IN THE NORTHEAST 1/4 AND THE NORTHWEST 1/4 OF THE SOUTHWEST 1/4 OF SECTION 29, TOWNSHIP 7 NORTH, RANGE 22 EAST, IN THE CITY OF MILWAUKEE, MILWAUKEE COUNTY, WISCONSIN. 1"=2000'

GRAEF

275 West Wisconsin Avenue, Suite 300
Milwaukee, WI 53203
414 / 259 1500
414 / 259 0037 fax
www.graef-usa.com

REFERENCE BEARING
BEARINGS ARE BASED ON THE NORTH LINE OF THE SW. 1/4 OF SECTION 29, TOWNSHIP 7 NORTH, RANGE 22 EAST, WHICH BEARS S 88°48'53" W AND IS REFERENCED TO THE WISCONSIN STATE PLANE COORDINATE SYSTEM, SOUTH ZONE, NAD27. (JAN. 2019 DATUM)

- LEGEND**
- FOUND 1" O.D. IRON PIPE
 - SET CUT CROSS
 - △ SET MAG NAIL
 - FOUND MONUMENT AS NOTED
 - RESTRICTED ACCESS

ZONING:
C9G

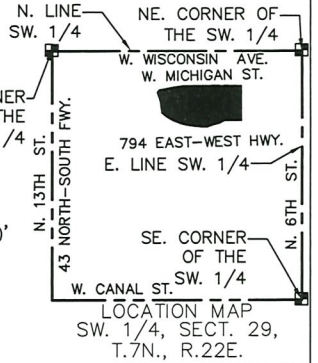
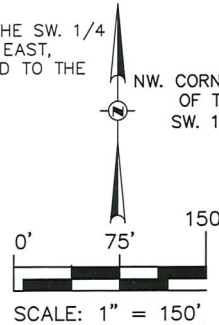

TAX KEY NO.: 361-0834-112, 361-0834-210, 361-0835-000, 361-0840-110, 361-0849-100, 361-0850-110, 389-117210.

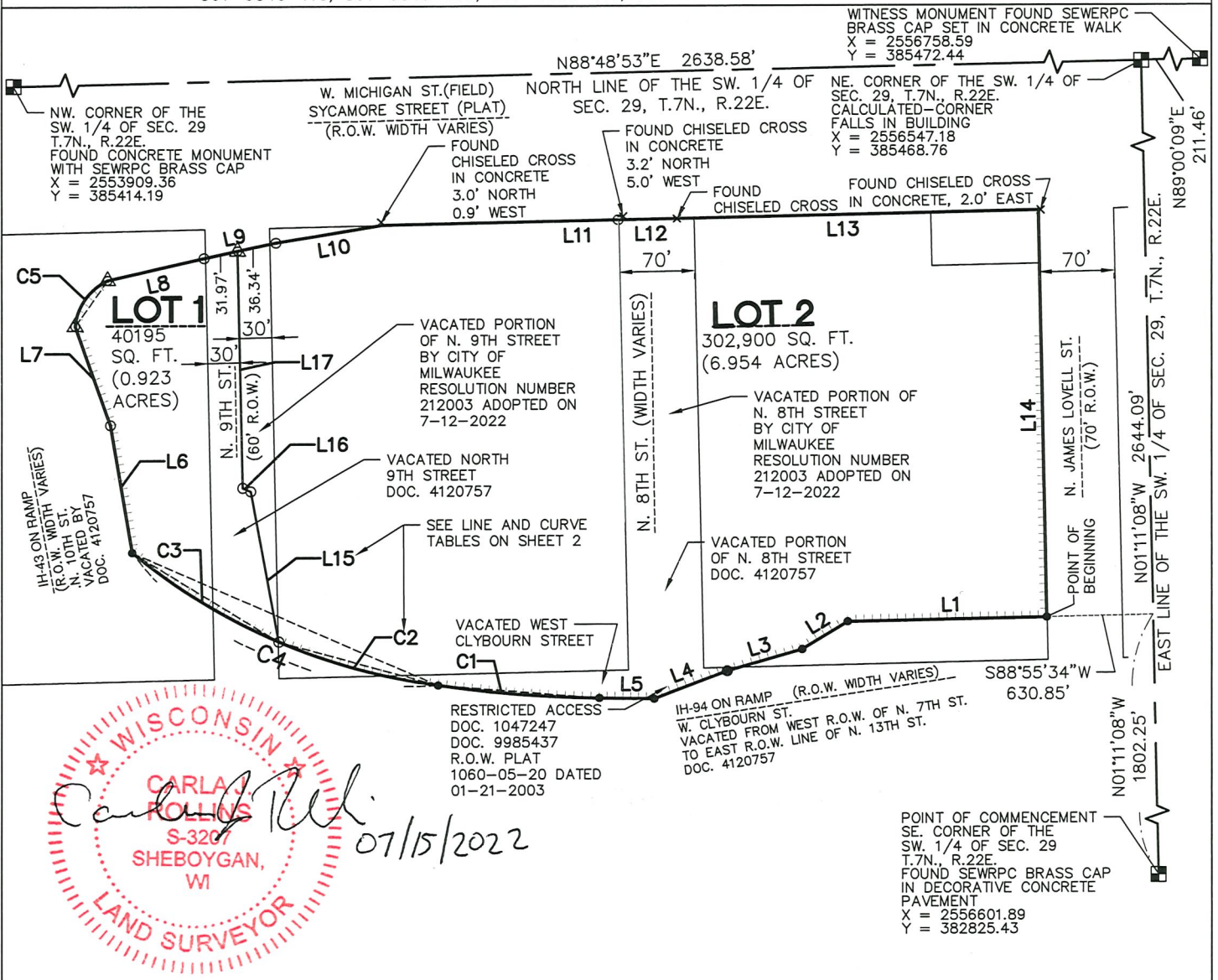

WISCONSIN
 CARLA J. ROLLINS
 S-3207
 SHEBOYGAN, WI
 LAND SURVEYOR

Carla J. Rollins
07/15/2022

INFRASTRUCTURE SERVICES DIVISION
Carla J. Rollins 7/19/2022
 CENTRAL DRAFTING & RECORDS MANAGER
 CDR for ENG. IN CHARGE 7-19-22
 ENGR. IN CHARGE ENVIRON. ENGR.
CORRECT
XEROX KAWAOKA
 CITY ENGINEER *OTC*
APPROVED

DEPARTMENT OF CITY DEVELOPMENT
 CITY OF MILWAUKEE
 APR 18 2022
[Signature]
STAFF APPROVED

CERTIFIED SURVEY MAP NO. _____

ALL OR PART OF LOTS 1 THROUGH 16 AND VACATED ALLEYS ADJACENT IN BLOCK 80 AND ALL OR PART OF LOTS 1 THROUGH 16 AND VACATED ALLEYS ADJACENT IN BLOCK 81 OF PART OF THE EAST HALF OF THE SOUTHWEST 1/4 OF SECTION 29, ALL OR PART OF LOTS 7, 10, 17 AND 18 IN BLOCK 81 AND ALL OR PART OF LOTS 1 THROUGH 13, 25 AND 26 IN BLOCK 246 OF JAMES KNEELAND'S SUBDIVISION, AND VACATED PORTIONS OF WEST CLYBOURN STREET, NORTH 8TH STREET AND NORTH 9TH STREET ADJACENT, ALL IN THE NORTHEAST 1/4 AND THE NORTHWEST 1/4 OF THE SOUTHWEST 1/4 OF SECTION 29, TOWNSHIP 7 NORTH, RANGE 22 EAST, IN THE CITY OF MILWAUKEE, MILWAUKEE COUNTY, WISCONSIN.



275 West Wisconsin Avenue, Suite 300
 Milwaukee, WI 53203
 414 / 259 1500
 414 / 259 0037 fax
 www.graef-usa.com

CURVE TABLE

CURVE #	LENGTH	RADIUS	DELTA	CHORD LENGTH	CHORD BEARING	TANGENT IN	TANGENT OUT
C1	150.68'	1105.92'	7°48'23"	150.56'	N85°18'05"W	N89°12'16"W	N81°23'54"W
C2	154.24'	570.96'	15°28'41"	153.77'	N74°22'18"W	N82°06'38"W	N66°37'57"W
C3	160.00'	570.96'	16°03'20"	159.47'	N58°36'17"W	N66°37'57"W	N50°34'37"W
C4	314.24'	570.96'	31°32'01"	310.29'	N66°20'38"W	N82°06'38"W	N50°34'37"W
C5	54.77'	51.42'	61°01'55"	52.22'	N35°15'13"E	N04°44'15"E	N65°46'11"E

LINE TABLE

LINE #	LENGTH	DIRECTION
L1	185.00'	S88°55'34"W
L2	49.45'	S58°41'20"W
L3	72.51'	S73°57'31"W
L4	72.50'	S69°12'57"W
L5	51.05'	N89°12'16"W
L6	121.08'	N09°37'34"W
L7	98.03'	N19°27'39"W
L8	91.89'	N77°24'06"E
L9	68.31'	N78°00'17"E
L10	100.39'	N80°42'24"E
L11	219.16'	N88°48'53"E
L12	54.85'	N88°54'58"E
L13	336.00'	N88°48'53"E
L14	380.11'	S01°06'14"E
L15	142.15'	N10°27'39"W
L16	8.29'	N65°46'36"W
L17	221.07'	N01°11'07"W

UTILITY EASEMENT PROVISIONS

AN EASEMENT FOR STORM SEWER AND SANITARY SEWER PURPOSES OVER, ABOVE, ALONG, UNDER, IN AND ACROSS LOT 1 IS GRANTED FOR THE BENEFIT OF LOT 2 TO EXCLUDE ANY AREAS THAT LIE WITHIN BUILDINGS:
 TO CONSTRUCT, INSTALL, OPERATE, REPAIR, MAINTAIN AND REPLACE A STORM SEWER LINE AND A SANITARY SEWER LINE AND RELATED FACILITIES OVER, ABOVE, ALONG, UNDER, IN AND ACROSS LOT 1, INCLUDING FOR SUCH PURPOSE THE RIGHT TO OPERATE THE NECESSARY EQUIPMENT THEREON AND THE RIGHT OF INGRESS AND EGRESS AS LONG AS REQUIRED FOR SUCH PURPOSE.

Carla J. Rollins

 07/15/2022

CERTIFIED SURVEY MAP NO. _____

ALL OR PART OF LOTS 1 THROUGH 16 AND VACATED ALLEYS ADJACENT IN BLOCK 80 AND ALL OR PART OF LOTS 1 THROUGH 16 AND VACATED ALLEYS ADJACENT IN BLOCK 81 OF PART OF THE EAST HALF OF THE SOUTHWEST 1/4 OF SECTION 29, ALL OR PART OF LOTS 7, 10, 17 AND 18 IN BLOCK 81 AND ALL OR PART OF LOTS 1 THROUGH 13, 25 AND 26 IN BLOCK 246 OF JAMES KNEELAND'S SUBDIVISION, AND VACATED PORTIONS OF WEST CLYBOURN STREET, NORTH 8TH STREET AND NORTH 9TH STREET ADJACENT, ALL IN THE NORTHEAST 1/4 AND THE NORTHWEST 1/4 OF THE SOUTHWEST 1/4 OF SECTION 29, TOWNSHIP 7 NORTH, RANGE 22 EAST, IN THE CITY OF MILWAUKEE, MILWAUKEE COUNTY, WISCONSIN.

GRAEF

275 West Wisconsin Avenue, Suite 300
 Milwaukee, WI 53203
 414 / 259 1500
 414 / 259 0037 fax
 www.graef-usa.com

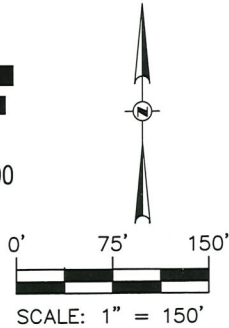

LINE TABLE		
LINE #	LENGTH	DIRECTION
L600	11.81'	N80°19'28"E
L601	99.66'	S10°50'57"E
L602	28.04'	S52°52'56"E
L603	51.25'	S57°02'05"E
L604	21.70'	N79°32'22"E
L605	151.55'	N15°52'39"W
L606	12.00'	N74°07'21"E
L607	112.24'	S15°52'39"E

LINE TABLE		
LINE #	LENGTH	DIRECTION
L608	81.21'	N05°38'43"W
L609	12.00'	N84°21'17"E
L610	138.16'	S05°38'43"E
L611	36.01'	S79°32'22"W
L612	6.35'	N60°20'48"W
L613	54.22'	N57°18'22"W
L614	39.93'	N52°34'51"W
L615	102.44'	N09°37'57"W

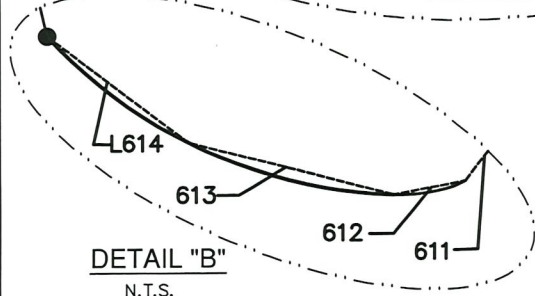
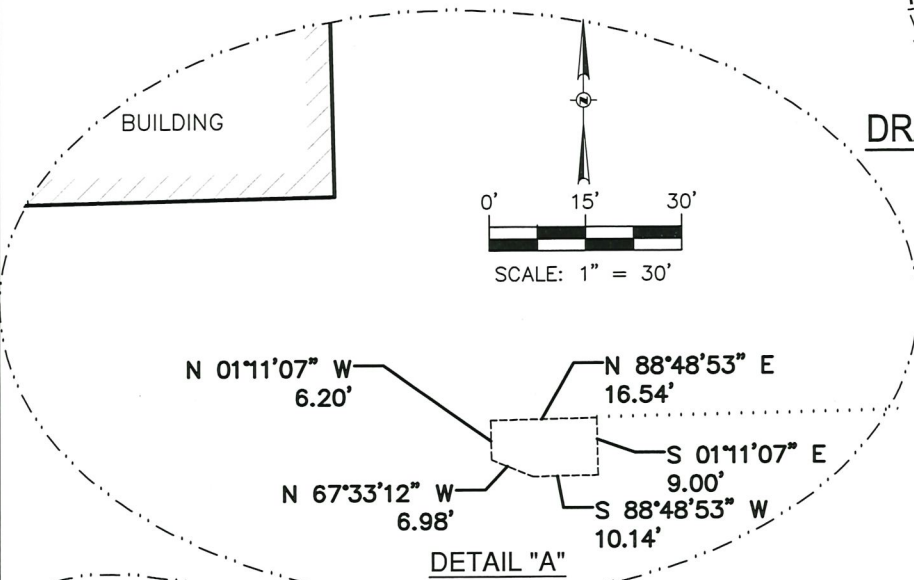
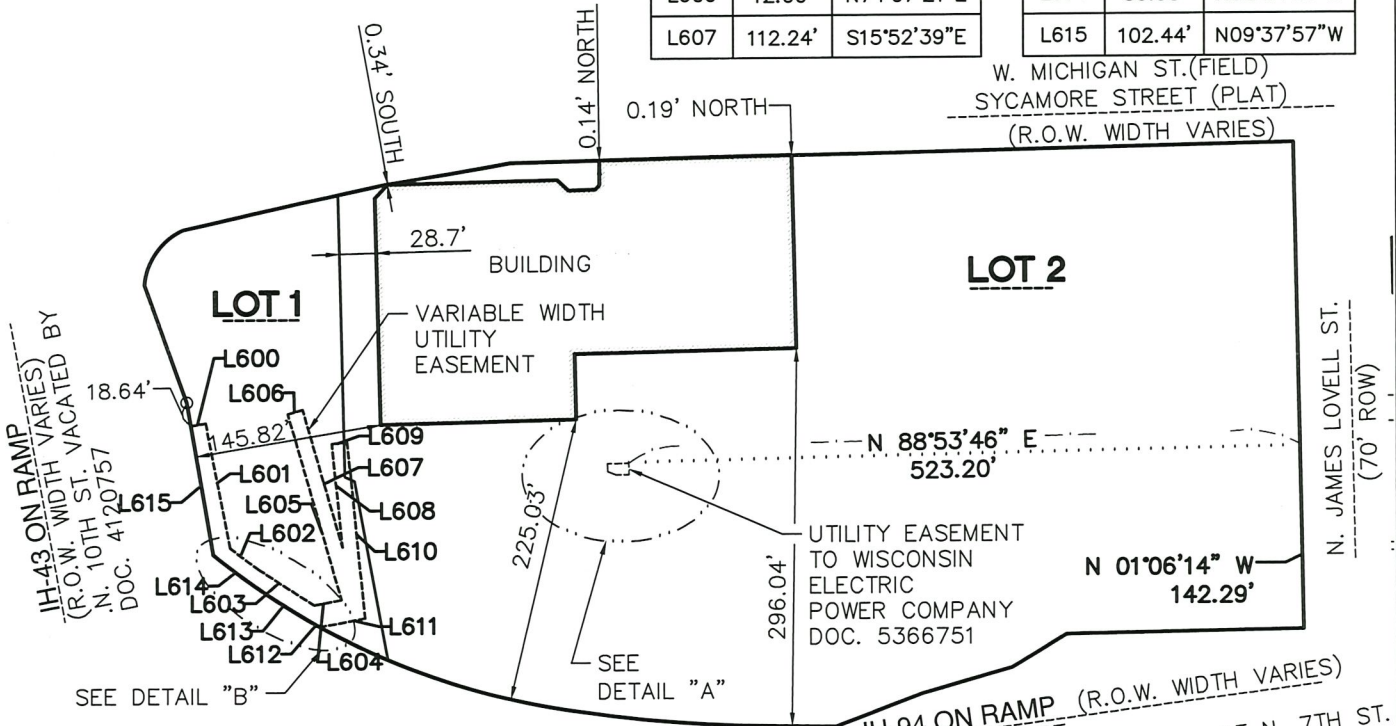

DRAINAGE EASEMENT PROVISIONS

A PERPETUAL, NON-EXCLUSIVE DRAINAGE EASEMENT OVER, UPON AND ACROSS LOT 1 IS GRANTED FOR THE BENEFIT OF LOT 2 FOR THE PURPOSE OF SURFACE DRAINING ANY AND ALL SURFACE WATER RUNOFF FROM LOT 2 AND THE IMPROVEMENTS WHICH MAY, FROM TIME TO TIME, BE CONSTRUCTED, ALTERED, MODIFIED AND MAINTAINED THEREON, OVER, UPON AND ACROSS LOT 1.

WISCONSIN
 CARLA J. ROLLINS
 PLS 3207
 SHEBOYGAN, WI
 LAND SURVEYOR
 07/15/2022

CERTIFIED SURVEY MAP NO. _____

ALL OR PART OF LOTS 1 THROUGH 16 AND VACATED ALLEYS ADJACENT IN BLOCK 80 AND ALL OR PART OF LOTS 1 THROUGH 16 AND VACATED ALLEYS ADJACENT IN BLOCK 81 OF PART OF THE EAST HALF OF THE SOUTHWEST 1/4 OF SECTION 29, ALL OR PART OF LOTS 7, 10, 17 AND 18 IN BLOCK 81 AND ALL OR PART OF LOTS 1 THROUGH 13, 25 AND 26 IN BLOCK 246 OF JAMES KNEELAND'S SUBDIVISION, AND VACATED PORTIONS OF WEST CLYBOURN STREET, NORTH 8TH STREET AND NORTH 9TH STREET ADJACENT, ALL IN THE NORTHEAST 1/4 AND THE NORTHWEST 1/4 OF THE SOUTHWEST 1/4 OF SECTION 29, TOWNSHIP 7 NORTH, RANGE 22 EAST, IN THE CITY OF MILWAUKEE, MILWAUKEE COUNTY, WISCONSIN.

SURVEYOR'S CERTIFICATE

STATE OF WISCONSIN
MILWAUKEE COUNTY

I, Carla J. Rollins, a Professional Land Surveyor, certify:

That I have surveyed, divided and mapped:

All or part of Lots 1 through 16 and vacated alleys adjacent in Block 80 and all or part of Lots 1 through 16 and vacated alleys adjacent in Block 81 of Part of the East Half of the Southwest 1/4 of Section 29, all or part of Lots 7, 10, 17 and 18 in Block 81 and all or part of Lots 1 through 13, 25 and 26 in Block 246 of James Kneeland's Subdivision, and vacated portions of West Clybourn Street, North 8th Street and North 9th Street adjacent, all in the Northeast 1/4 and the Northwest 1/4 of the Southwest 1/4 of Section 29, Township 7 North, Range 22 East, in the City of Milwaukee, Milwaukee County, Wisconsin being more particularly described as follows:

Commencing at the Southeast corner of the Southwest 1/4 of said Section 29; thence North 01°11'08" West along the East line of the Southwest 1/4 of said Section 29, 1802.25 feet; thence South 88°55'34" West, 630.85 feet to a point which is the intersection of the West right-of-way line of North James Lovell street with the North right-of-way line of the entrance ramp of Interstate Highway 94 and being the point of beginning of the herein described parcel; thence continue South 88°55'34" West along said North right-of-way line, 185.00 feet; thence South 58°41'20" West along said North right-of-way line, 49.45 feet; thence South 73°57'31" West, along said North right-of-way line, 72.51 feet; thence South 69°12'57" West along said North right-of-way line, 72.50 feet; thence North 89°12'16" West along said North right-of-way line, 51.05 feet to a point of curvature of a curve concave to the Northeast having a radius of 1105.92 feet; thence westerly and northwesterly along the arc of said curve and along said North right-of-way line through a central angle of 07°48'23", having a chord bearing of North 85°18'05" West and a chord length of 150.56 feet, a distance of 150.68 feet to a point of curvature of a non-tangent curve concave to the Northeast having a radius of 570.96 feet and a radial bearing of North 07°53'22" East; thence northwesterly along the arc of said curve and along said North right-of-way line through a central angle of 31°32'01", having a chord bearing of North 66°20'38" West and a chord length of 310.29 feet, a distance of 314.24 feet to a point of intersection with the East right-of-way line of the entrance ramp of Interstate Highway 43; thence North 09°37'34" West along said East right-of-way line, 121.08 feet; thence North 19°27'39" West along said East right-of-way line, 98.03 feet to a point of curvature of a non-tangent curve concave to the Southeast having a radius of 51.42 feet and a radial bearing of South 85°15'45" East; thence Northeasterly along the arc of said curve through a central angle of 61°01'55", having a chord bearing of North 35°15'13" East and a chord length of 52.22 feet, a distance of 54.77 feet to a point of intersection with the South right-of-way line of West Michigan Street; thence North 77°24'06" East along said South right-of-way line, 91.89 feet; thence North 78°00'17" East along said South right-of-way line, 68.31 feet; thence North 80°42'24" East along said South right-of-way line, 100.39 feet; thence North 88°48'53" East along said South right-of-way line, 219.16 feet; thence North 88°54'58" East along said South right-of-way line, 54.85 feet; thence North 88°48'53" East along said South right-of-way line, 336.00 feet to a point of intersection with the West right-of-way line of North James Lovell Street; thence South 01°06'14" East, along said West right-of-way line, 380.11 feet to the point of beginning.

Said parcel containing 7.876 acres of land more or less.



07/15/2022

CERTIFIED SURVEY MAP NO. _____

ALL OR PART OF LOTS 1 THROUGH 16 AND VACATED ALLEYS ADJACENT IN BLOCK 80 AND ALL OR PART OF LOTS 1 THROUGH 16 AND VACATED ALLEYS ADJACENT IN BLOCK 81 OF PART OF THE EAST HALF OF THE SOUTHWEST 1/4 OF SECTION 29, ALL OR PART OF LOTS 7, 10, 17 AND 18 IN BLOCK 81 AND ALL OR PART OF LOTS 1 THROUGH 13, 25 AND 26 IN BLOCK 246 OF JAMES KNEELAND'S SUBDIVISION, AND VACATED PORTIONS OF WEST CLYBOURN STREET, NORTH 8TH STREET AND NORTH 9TH STREET ADJACENT, ALL IN THE NORTHEAST 1/4 AND THE NORTHWEST 1/4 OF THE SOUTHWEST 1/4 OF SECTION 29, TOWNSHIP 7 NORTH, RANGE 22 EAST, IN THE CITY OF MILWAUKEE, MILWAUKEE COUNTY, WISCONSIN.

That I have made the survey, land division, and map by the direction of West Michigan Investments, LLC and 9th Street Holdings, LLC.

That the map is a correct representation of all the exterior boundaries of the land surveyed and the land division thereof made.

That I have complied with Chapter 236 of the Wisconsin Statutes and Chapter 119 of the Milwaukee Code of Ordinances in surveying, dividing and mapping the same. Per Wis. Stat. 236.21 (1), this certificate has the same force and effect as an affidavit.

Date: 07/15/2022

Signature: Carla J. Rollins

Carla J. Rollins, Professional Land Surveyor, Number: 3207



07/15/2022

CERTIFIED SURVEY MAP NO. _____

ALL OR PART OF LOTS 1 THROUGH 16 AND VACATED ALLEYS ADJACENT IN BLOCK 80 AND ALL OR PART OF LOTS 1 THROUGH 16 AND VACATED ALLEYS ADJACENT IN BLOCK 81 OF PART OF THE EAST HALF OF THE SOUTHWEST 1/4 OF SECTION 29, ALL OR PART OF LOTS 7, 10, 17 AND 18 IN BLOCK 81 AND ALL OR PART OF LOTS 1 THROUGH 13, 25 AND 26 IN BLOCK 246 OF JAMES KNEELAND'S SUBDIVISION, AND VACATED PORTIONS OF WEST CLYBOURN STREET, NORTH 8TH STREET AND NORTH 9TH STREET ADJACENT, ALL IN THE NORTHEAST 1/4 AND THE NORTHWEST 1/4 OF THE SOUTHWEST 1/4 OF SECTION 29, TOWNSHIP 7 NORTH, RANGE 22 EAST, IN THE CITY OF MILWAUKEE, MILWAUKEE COUNTY, WISCONSIN.

ENTITY OWNER'S CERTIFICATE

West Michigan Investments, LLC, a Wisconsin limited liability company, duly organized and existing under and by virtue of the laws of the State of Wisconsin, as owner, certifies that said entity caused the land described on this certified survey map to be surveyed, divided, and mapped as represented on this map in accordance with the requirements of Chapter 236 of the Wisconsin Statutes and Chapter 119 of the Milwaukee Code of Ordinances. I also certify that this Certified Survey Map is required to be submitted to the following for approval: City of Milwaukee.

In consideration of the approval of the map by the Milwaukee Common Council, the undersigned agrees:

That all utility lines to provide electric power and telephone service and cable television or communications systems lines or cables to all lots in the certified survey map (other than already- existing lines and cables) shall be installed underground in easements provided therefore, where feasible.

That direct vehicular access from Lots 1 and 2 to Interstate Highways 94 and 43 and from Lot 2 to North James Lovell Street is prohibited as delineated on the attached map.

This agreement is binding on the undersigned and successors and assigns.

Date: 7-15-2022

Entity Name: West Michigan Investments, LLC

Signature: [Handwritten Signature]

Type or Print Name: Stephen R. Mills

Title: Authorized Member

STATE OF WISCONSIN

MILWAUKEE COUNTY

Personally came before me this 15 day of July, 2022, Stephen R. Mills, the Authorized Member of the above named entity, to me known to be the person who executed the foregoing instrument, and acknowledged that he/she executed the foregoing instrument as such officer on behalf of the entity, by its authority.

Notary Signature: Alexander Faust

Print Notary Name: Alexander Faust

Notary Public, State of Wisconsin My commission expires: 7/21/23

(Notary Seal)

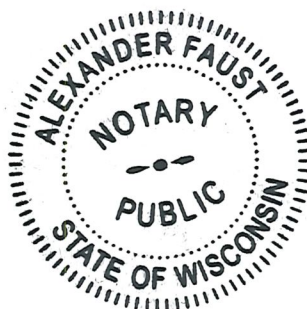

CERTIFIED SURVEY MAP NO. _____

ALL OR PART OF LOTS 1 THROUGH 16 AND VACATED ALLEYS ADJACENT IN BLOCK 80 AND ALL OR PART OF LOTS 1 THROUGH 16 AND VACATED ALLEYS ADJACENT IN BLOCK 81 OF PART OF THE EAST HALF OF THE SOUTHWEST 1/4 OF SECTION 29, ALL OR PART OF LOTS 7, 10, 17 AND 18 IN BLOCK 81 AND ALL OR PART OF LOTS 1 THROUGH 13, 25 AND 26 IN BLOCK 246 OF JAMES KNEELAND'S SUBDIVISION, AND VACATED PORTIONS OF WEST CLYBOURN STREET, NORTH 8TH STREET AND NORTH 9TH STREET ADJACENT, ALL IN THE NORTHEAST 1/4 AND THE NORTHWEST 1/4 OF THE SOUTHWEST 1/4 OF SECTION 29, TOWNSHIP 7 NORTH, RANGE 22 EAST, IN THE CITY OF MILWAUKEE, MILWAUKEE COUNTY, WISCONSIN.

ENTITY OWNER'S CERTIFICATE

9th Street Holdings, LLC, a Wisconsin limited liability company, duly organized and existing under and by virtue of the laws of the State of Wisconsin, as owner, certifies that said entity caused the land described on this certified survey map to be surveyed, divided, and mapped as represented on this map in accordance with the requirements of Chapter 236 of the Wisconsin Statutes and Chapter 119 of the Milwaukee Code of Ordinances. I also certify that this Certified Survey Map is required to be submitted to the following for approval: City of Milwaukee.

In consideration of the approval of the map by the Milwaukee Common Council, the undersigned agrees:

That all utility lines to provide electric power and telephone service and cable television or communications systems lines or cables to all lots in the certified survey map (other than already-existing lines and cables) shall be installed underground in easements provided therefore, where feasible.

That direct vehicular access from Lots 1 and 2 to Interstate Highways 94 and 43 and from Lot 2 to North James Lovell Street is prohibited as delineated on the attached map.

This agreement is binding on the undersigned and successors and assigns.

Date: 7-15-2022

Entity Name: 9th Street Holdings, LLC

Signature: _____

Type or Print Name: Stephen R. Mills

Title: Authorized Member

STATE OF WISCONSIN

MILWAUKEE COUNTY

Personally came before me this 15 day of July, 2022. Stephen R. Mills, the Authorized Member of the above named entity, to me known to be the person who executed the foregoing instrument, and acknowledged that he/she executed the foregoing instrument as such officer on behalf of the entity, by its authority.

Notary Signature: Alexander Faust

Print Notary Name: Alexander Faust

Notary Public, State of Wisconsin My commission expires: 7/21/23

(Notary Seal)

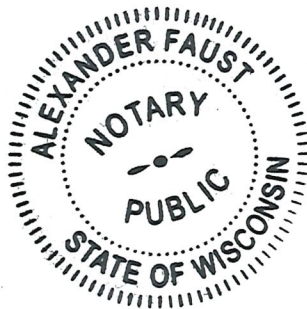

07/15/2022

CERTIFIED SURVEY MAP NO. _____

ALL OR PART OF LOTS 1 THROUGH 16 AND VACATED ALLEYS ADJACENT IN BLOCK 80 AND ALL OR PART OF LOTS 1 THROUGH 16 AND VACATED ALLEYS ADJACENT IN BLOCK 81 OF PART OF THE EAST HALF OF THE SOUTHWEST 1/4 OF SECTION 29, ALL OR PART OF LOTS 7, 10, 17 AND 18 IN BLOCK 81 AND ALL OR PART OF LOTS 1 THROUGH 13, 25 AND 26 IN BLOCK 246 OF JAMES KNEELAND'S SUBDIVISION, AND VACATED PORTIONS OF WEST CLYBOURN STREET, NORTH 8TH STREET AND NORTH 9TH STREET ADJACENT, ALL IN THE NORTHEAST 1/4 AND THE NORTHWEST 1/4 OF THE SOUTHWEST 1/4 OF SECTION 29, TOWNSHIP 7 NORTH, RANGE 22 EAST, IN THE CITY OF MILWAUKEE, MILWAUKEE COUNTY, WISCONSIN.

CONSENT OF ENTITY MORTGAGEE

FIRE Subsidiary CDE 26, LLC, a Wisconsin limited liability company, duly organized and existing under and by virtue of the laws of the State of Wisconsin, as mortgagee of the above described land, consents to the surveying, dividing, mapping, and restricting of the land described on this map and in the surveyor's certificate, and to the certificate of the owner(s) of said land.

Date: 7-15-22

Entity Name: First-Ring Industrial Redevelopment Enterprise Inc.

Signature: John F. Stibal

Type or Print Name: John F. Stibal

Title: President

STATE OF Wisconsin

Milwaukee COUNTY

Personally came before me this 15 day of July, 2022, _____ (name and title) of the above named entity, to me known to be the person who executed the foregoing instrument, and acknowledged that he/she executed the foregoing instrument as such officer on behalf of the entity, by its authority.

Notary Signature: Alexander Faust

Print Notary Name: Alexander Faust

Notary Public, State of Wisconsin My commission expires: 7/21/23

(Notary Seal)

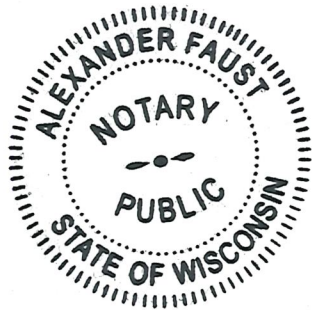

07/15/2022

CERTIFIED SURVEY MAP NO. _____

ALL OR PART OF LOTS 1 THROUGH 16 AND VACATED ALLEYS ADJACENT IN BLOCK 80 AND ALL OR PART OF LOTS 1 THROUGH 16 AND VACATED ALLEYS ADJACENT IN BLOCK 81 OF PART OF THE EAST HALF OF THE SOUTHWEST 1/4 OF SECTION 29, ALL OR PART OF LOTS 7, 10, 17 AND 18 IN BLOCK 81 AND ALL OR PART OF LOTS 1 THROUGH 13, 25 AND 26 IN BLOCK 246 OF JAMES KNEELAND'S SUBDIVISION, AND VACATED PORTIONS OF WEST CLYBOURN STREET, NORTH 8TH STREET AND NORTH 9TH STREET ADJACENT, ALL IN THE NORTHEAST 1/4 AND THE NORTHWEST 1/4 OF THE SOUTHWEST 1/4 OF SECTION 29, TOWNSHIP 7 NORTH, RANGE 22 EAST, IN THE CITY OF MILWAUKEE, MILWAUKEE COUNTY, WISCONSIN.

CERTIFICATE OF CITY TREASURER

I, Spencer Coggs, being the duly elected and acting City Treasurer of the City of Milwaukee, certify that in accordance with the records in the office of the City Treasurer of the City of Milwaukee there are no unpaid taxes or unpaid special assessments on the land included in this certified survey map.

Per Wis. Stat. 75.06 and 74.87, the City of Milwaukee collects property taxes and enforces nonpayment of same on parcels in the City of Milwaukee. Per Wis. Stat. 74.83, the City of Milwaukee and Milwaukee County entered into an Intergovernmental Cooperation Agreement approved by Council Resolution 901408, whereby the city is the sole collector and enforcer of property taxes for parcels in the city.

Date: 07/19/2022

Signature: James F. Klabor

Type or Print Name: JAMES F. KLABOR, DEPUTY
for (Spencer Coggs)

CERTIFICATE OF CITY CLERK REGARDING COMMON COUNCIL APPROVAL

I certify that this certified survey map was approved under Resolution File No. _____ adopted by the Common Council of the City of Milwaukee on _____.

Date: _____

Signature: _____

Type or Print Name: _____
(James Owczarski)



07/15/2022