



Certificate of Appropriateness

Milwaukee Historic Preservation Commission/200 E. Wells Street/Milwaukee, WI 53202/phone 414-286-5712/fax 414-286-3004

Property

1241 N. FRANKLIN PL. First Ward Triangle Historic District

Description of work

The Lynde and Harry Bradley Foundation, Inc. occupy three buildings in the First Ward Triangle Historic District. The rear, asphalt-paved parking lot behind the buildings has been in place since 1995 and received no objections from neighboring owners. Fencing and landscaping have made the parking area unobtrusive in the neighborhood. The 1995 Certificate of Appropriateness was issued under the address 1123-1125 E. Knapp Street.

The current proposal will carve out additional spaces by providing tandem parking spaces in two areas as well as reducing some of the green landscape buffer behind 1115 and 1119 East Knapp Street. The number of parking spaces will increase from 21 to 36 spaces.

The existing wood fencing will be removed and new wood fencing installed to match at the new boundaries of the parking areas. The masonry piers with their security devices will be removed. A new, poured concrete retaining wall will be constructed at the southwest corner of the project area that will extend from 2-foot to 3-foot-6-inches above grade. At this location, the fencing will be installed above the retaining wall.

New landscaping will be installed to replace the trees and other plantings removed for the expansion.

New light poles will be installed with new lamps.

Date issued

5/31/2016

PTS ID 111175 COA Enlarge Rear Parking Lot

In accordance with the provisions of Section 320-21 (11) and (12) of the Milwaukee Code of Ordinances, the Milwaukee Historic Preservation Commission has issued a certificate of appropriateness for the work listed above. The work was found to be consistent with preservation guidelines. The following conditions apply to this certificate of appropriateness:

All work to be carried out according to the plans submitted. The French Gothic-topped wood picket fence will front East Knapp Street as at present. The remainder of the fencing will consist of flat topped wood pickets. Both styles will be 6-feet tall. The fence will be painted upon completion. The new light posts are of simple design. The new plantings in the perimeter landscaping will include deciduous trees, deciduous shrubs, and perennials.

All work must be done in a craftsman-like manner, and must be completed within one year of the date this certificate was issued. Staff must approve any changes or additions to this certificate before work begins. Work that is not completed in accordance with this certificate may be subject to correction orders or citations. If you require technical assistance, please contact Carlen Hatala of the Historic Preservation staff as follows: Phone: (414) 286-5722 Fax: (414) 286-3004 E-mail: carlen.hatala@milwaukee.gov.

If permits are required, you are responsible for obtaining them from the Milwaukee Development Center. If you have questions about permit requirements, please consult the Development Center's web site, www.milwaukee.gov/build, or call (414) 286-8210.

A handwritten signature in black ink, appearing to read "Carlen Hatala". The signature is written in a cursive style with a long horizontal stroke extending to the right.

City of Milwaukee Historic Preservation Staff

Copies to: Development Center, Ald. Robert Bauman, Contractor, Inspector Peter Schwartz (286-2537)



Aerial view of rear parking lot.

Masonry piers with security devices to be removed.



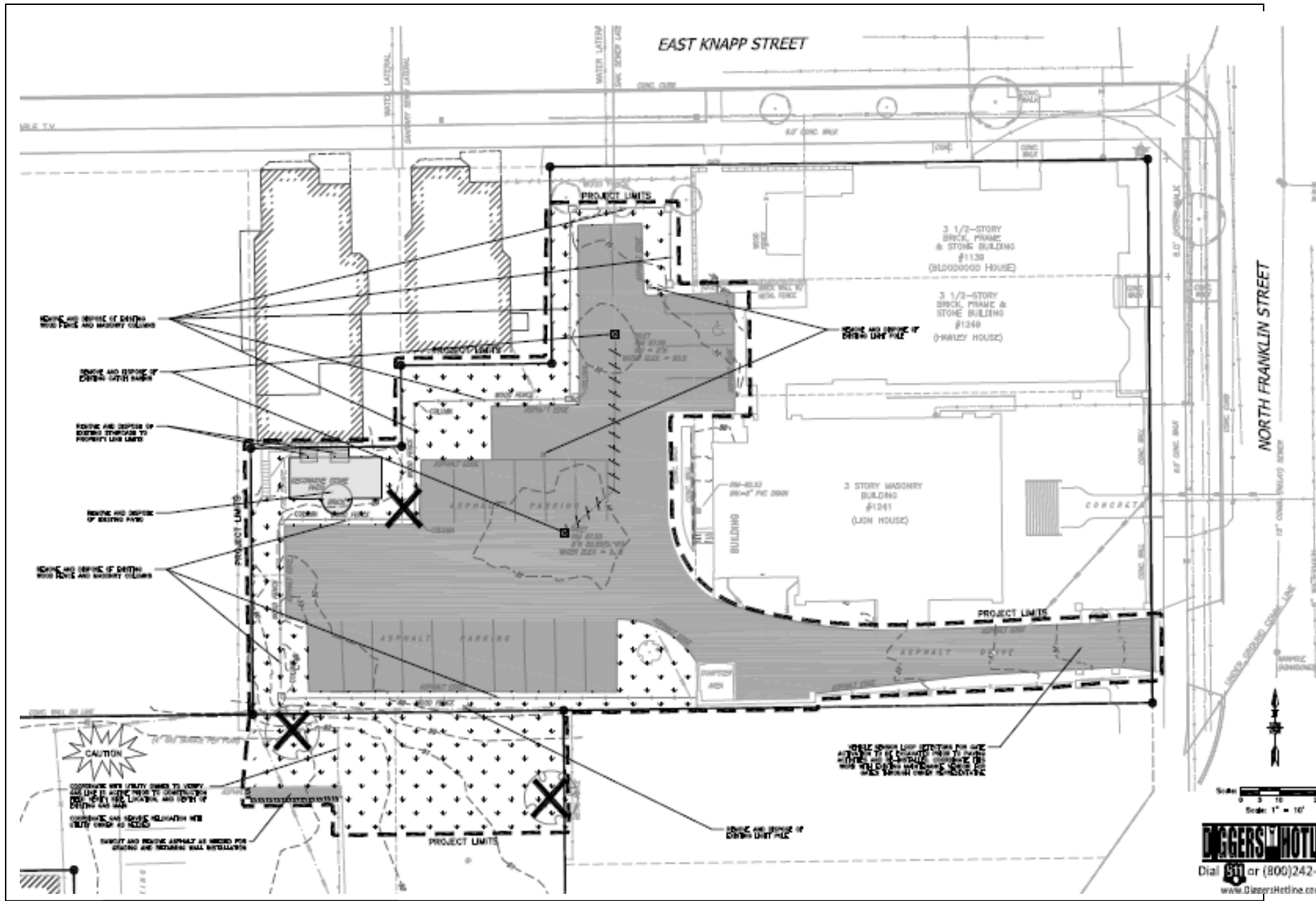

Current Plan of lot

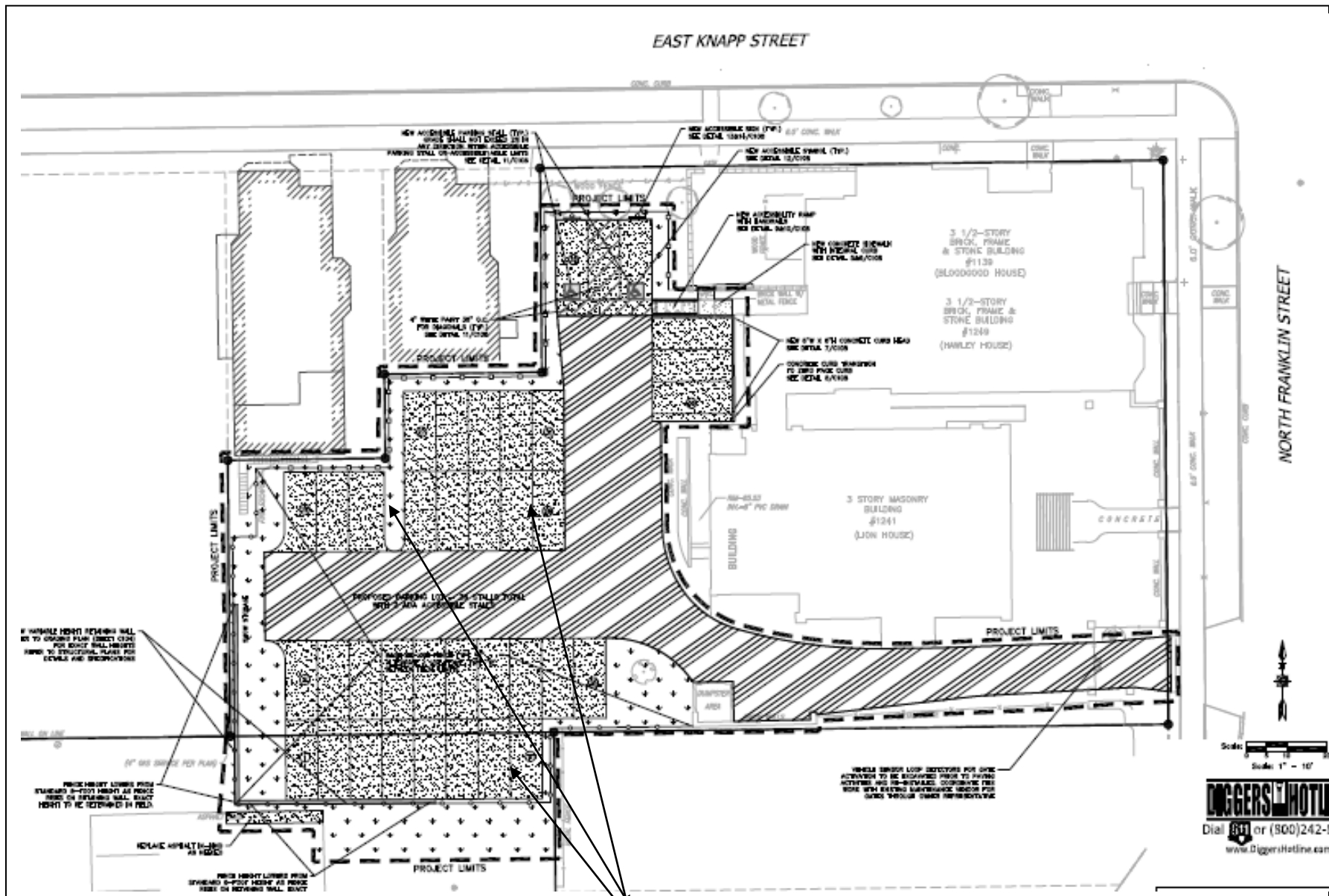

Proposed changes to lot. New parking stalls.



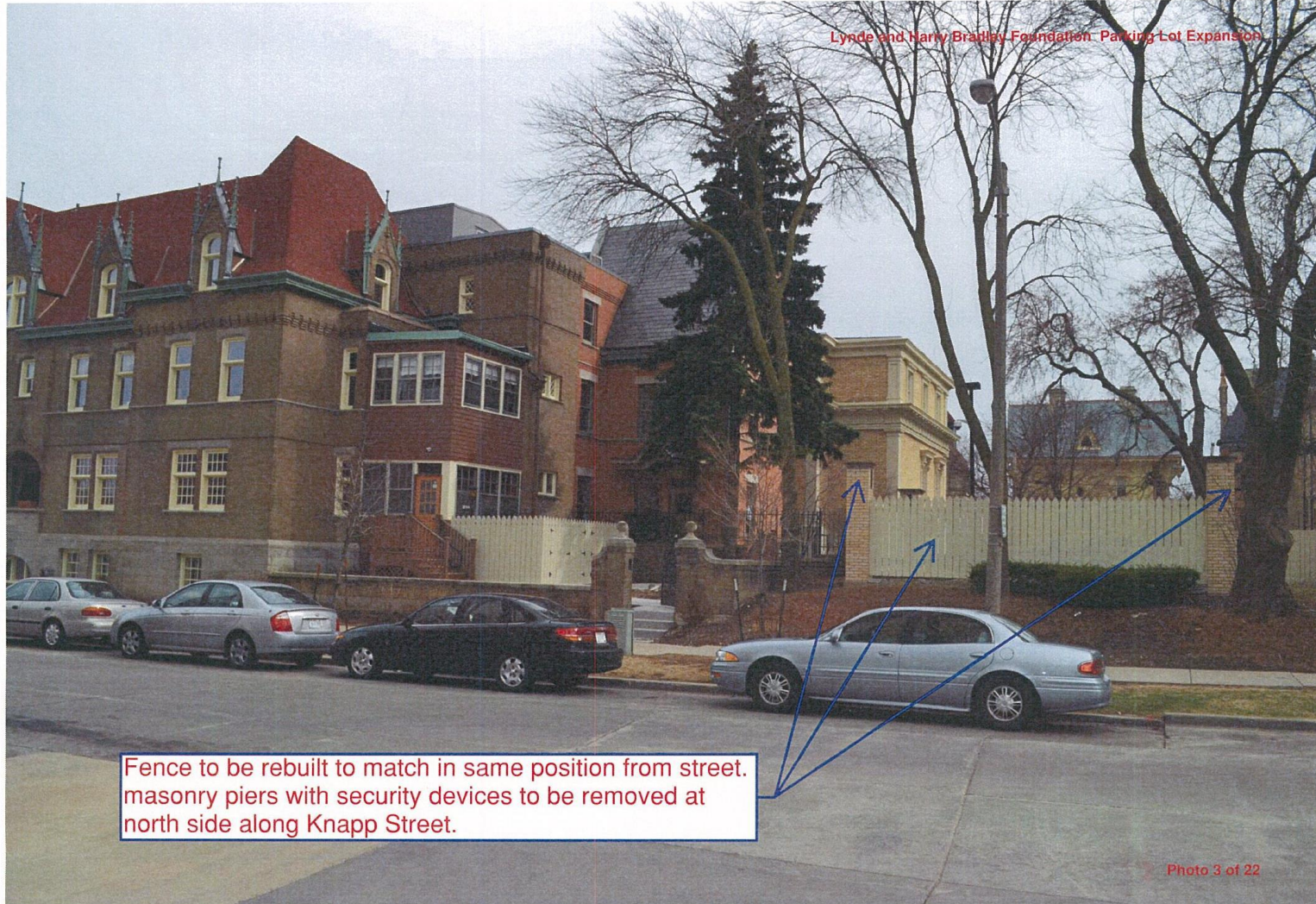

Fence to be rebuilt to match in same position from street. masonry piers with security devices to be removed at north side along Knapp Street.

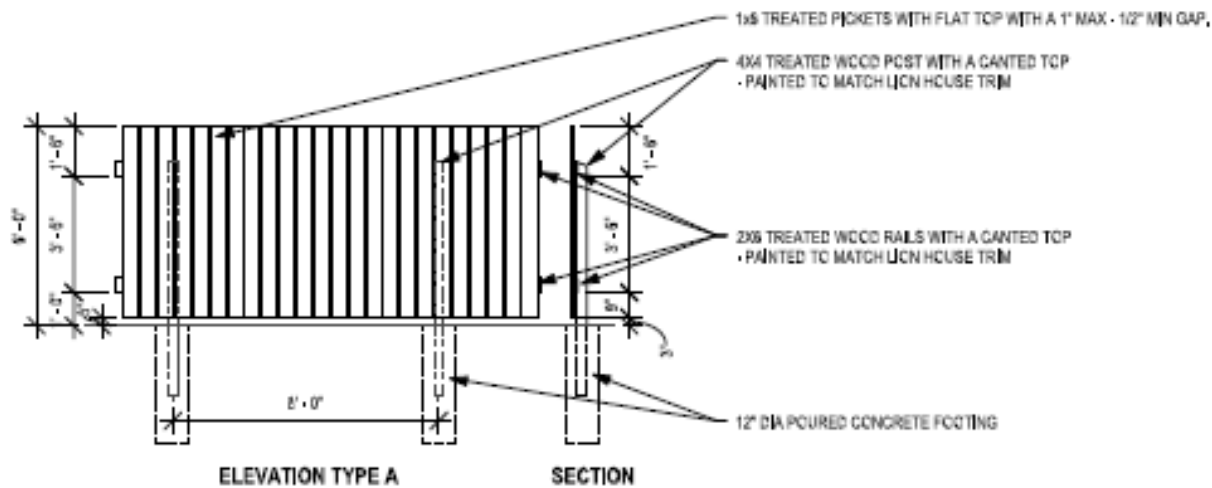

19 FENCE TYPE "A"
 KFL

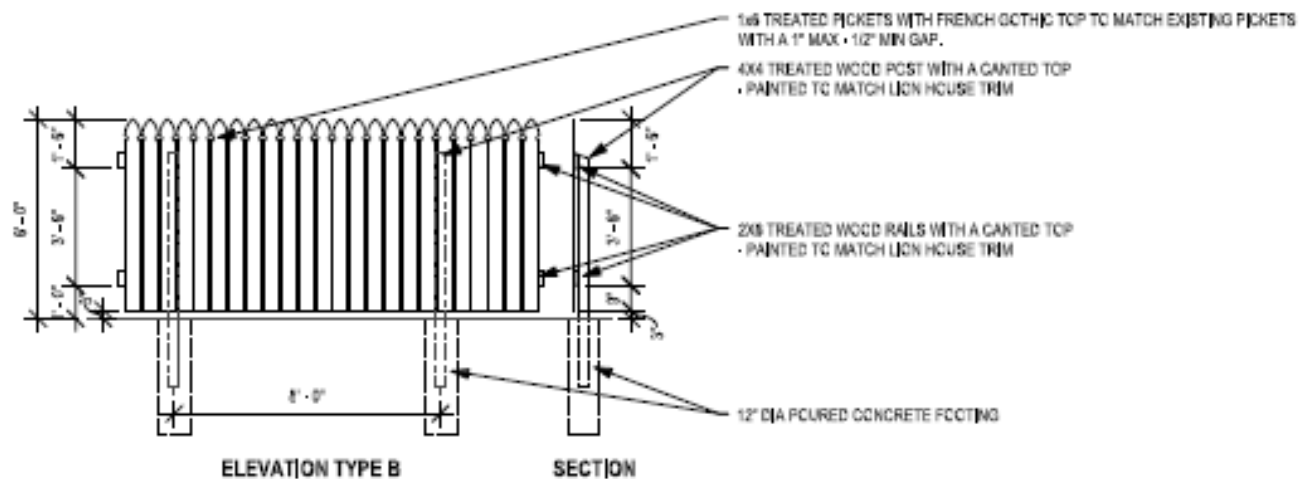

20 FENCE TYPE "B"
 KFL

Fence design will remain the same but be relocated to conform to adjusted boundaries of the parking area

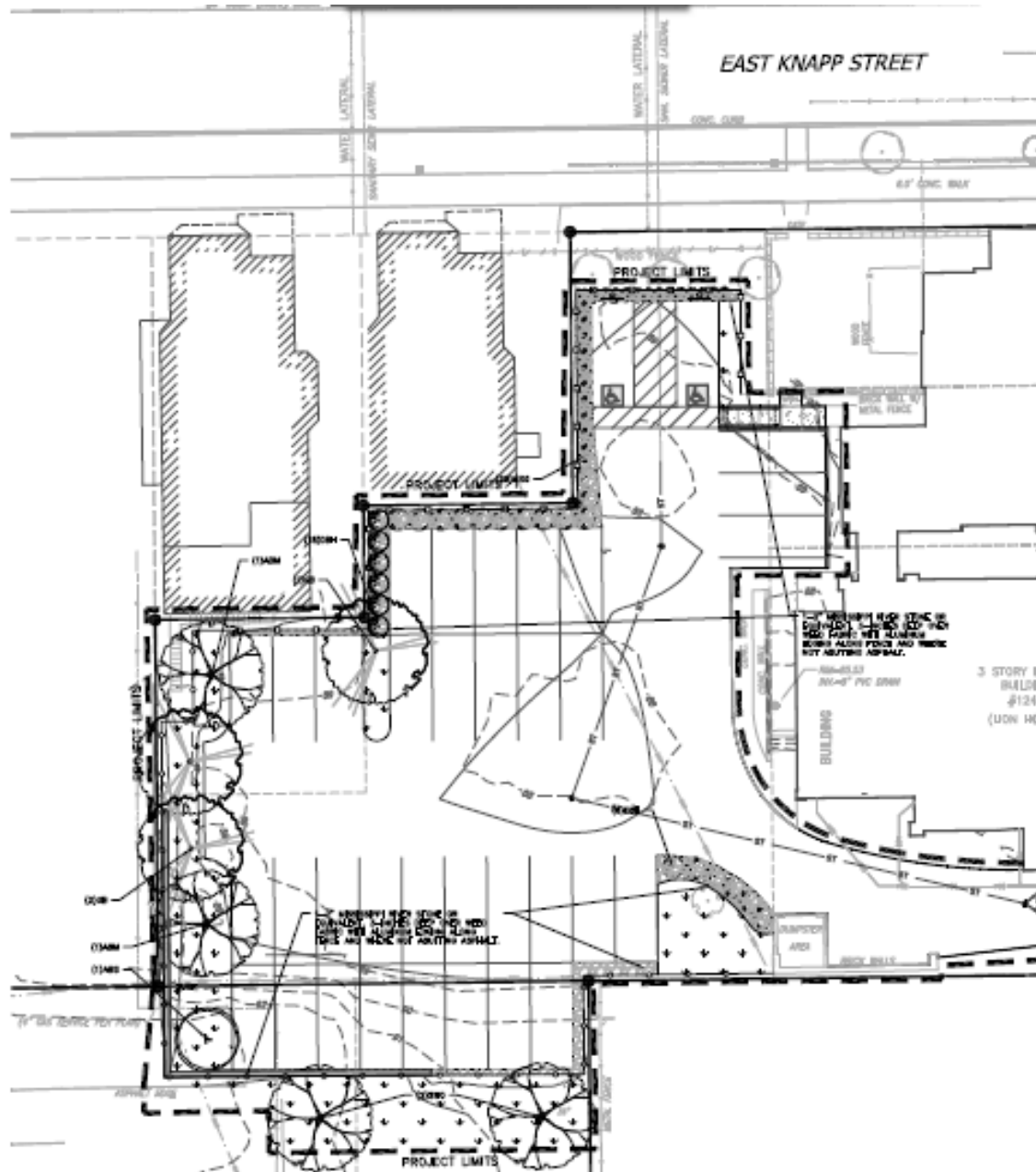

Plant Schedule

Symbol	Scientific Name	Common Name
(Symbol)	Tree	
(Symbol)	Shrub	
(Symbol)	Plant	
(Symbol)	Grass	

1 LANDSCAPE SCHEDULE

- 1. ALL PLANT MATERIAL SHALL BE OBTAINED FROM A REPUTABLE SOURCE IN ZONE 5, CONFORMING TO SPECIFICATIONS AND REQUIREMENTS AS SET FORTH IN THE CURRENT EDITION OF STANDARD SPECIFICATIONS.
- 2. CONTRACTOR TO PROVIDE TO THE LANDSCAPE ARCHITECT SCHEDULES OF ALL BARS AND REINFORCEMENT TO BE USED IN ALL CONCRETE WORK.
- 3. BARS SHALL BE PROPERLY ANCHORED AND SPACED AS SHOWN ON DRAWINGS. NO DOUBLE BARS SHALL BE USED UNLESS SPECIFICALLY NOTED OTHERWISE.
- 4. ALL PLANTING SHALL BE DONE IN ACCORDANCE WITH THE SPECIFICATIONS TO THE STANDARD SPECIFICATIONS.
- 5. ALL PLANTING SHALL BE DONE IN ACCORDANCE WITH THE SPECIFICATIONS TO THE STANDARD SPECIFICATIONS.
- 6. CONTRACTOR SHALL BE RESPONSIBLE FOR MAINTENANCE OF ALL PLANTING FOR A PERIOD OF ONE YEAR AFTER PLANTING. THIS PERIOD SHALL INCLUDE WATERING, FERTILIZING, AND WEED CONTROL AS NECESSARY TO MAINTAIN THE PLANTING IN A HEALTHY STATE.
- 7. CONTRACTOR SHALL BE RESPONSIBLE FOR MAINTENANCE OF ALL PLANTING FOR A PERIOD OF ONE YEAR AFTER PLANTING. THIS PERIOD SHALL INCLUDE WATERING, FERTILIZING, AND WEED CONTROL AS NECESSARY TO MAINTAIN THE PLANTING IN A HEALTHY STATE.
- 8. CONTRACTOR SHALL BE RESPONSIBLE FOR MAINTENANCE OF ALL PLANTING FOR A PERIOD OF ONE YEAR AFTER PLANTING. THIS PERIOD SHALL INCLUDE WATERING, FERTILIZING, AND WEED CONTROL AS NECESSARY TO MAINTAIN THE PLANTING IN A HEALTHY STATE.
- 9. CONTRACTOR SHALL BE RESPONSIBLE FOR MAINTENANCE OF ALL PLANTING FOR A PERIOD OF ONE YEAR AFTER PLANTING. THIS PERIOD SHALL INCLUDE WATERING, FERTILIZING, AND WEED CONTROL AS NECESSARY TO MAINTAIN THE PLANTING IN A HEALTHY STATE.
- 10. CONTRACTOR SHALL BE RESPONSIBLE FOR MAINTENANCE OF ALL PLANTING FOR A PERIOD OF ONE YEAR AFTER PLANTING. THIS PERIOD SHALL INCLUDE WATERING, FERTILIZING, AND WEED CONTROL AS NECESSARY TO MAINTAIN THE PLANTING IN A HEALTHY STATE.
- 11. CONTRACTOR SHALL BE RESPONSIBLE FOR MAINTENANCE OF ALL PLANTING FOR A PERIOD OF ONE YEAR AFTER PLANTING. THIS PERIOD SHALL INCLUDE WATERING, FERTILIZING, AND WEED CONTROL AS NECESSARY TO MAINTAIN THE PLANTING IN A HEALTHY STATE.
- 12. CONTRACTOR SHALL BE RESPONSIBLE FOR MAINTENANCE OF ALL PLANTING FOR A PERIOD OF ONE YEAR AFTER PLANTING. THIS PERIOD SHALL INCLUDE WATERING, FERTILIZING, AND WEED CONTROL AS NECESSARY TO MAINTAIN THE PLANTING IN A HEALTHY STATE.
- 13. CONTRACTOR SHALL BE RESPONSIBLE FOR MAINTENANCE OF ALL PLANTING FOR A PERIOD OF ONE YEAR AFTER PLANTING. THIS PERIOD SHALL INCLUDE WATERING, FERTILIZING, AND WEED CONTROL AS NECESSARY TO MAINTAIN THE PLANTING IN A HEALTHY STATE.
- 14. CONTRACTOR SHALL BE RESPONSIBLE FOR MAINTENANCE OF ALL PLANTING FOR A PERIOD OF ONE YEAR AFTER PLANTING. THIS PERIOD SHALL INCLUDE WATERING, FERTILIZING, AND WEED CONTROL AS NECESSARY TO MAINTAIN THE PLANTING IN A HEALTHY STATE.
- 15. CONTRACTOR SHALL BE RESPONSIBLE FOR MAINTENANCE OF ALL PLANTING FOR A PERIOD OF ONE YEAR AFTER PLANTING. THIS PERIOD SHALL INCLUDE WATERING, FERTILIZING, AND WEED CONTROL AS NECESSARY TO MAINTAIN THE PLANTING IN A HEALTHY STATE.
- 16. CONTRACTOR SHALL BE RESPONSIBLE FOR MAINTENANCE OF ALL PLANTING FOR A PERIOD OF ONE YEAR AFTER PLANTING. THIS PERIOD SHALL INCLUDE WATERING, FERTILIZING, AND WEED CONTROL AS NECESSARY TO MAINTAIN THE PLANTING IN A HEALTHY STATE.
- 17. CONTRACTOR SHALL BE RESPONSIBLE FOR MAINTENANCE OF ALL PLANTING FOR A PERIOD OF ONE YEAR AFTER PLANTING. THIS PERIOD SHALL INCLUDE WATERING, FERTILIZING, AND WEED CONTROL AS NECESSARY TO MAINTAIN THE PLANTING IN A HEALTHY STATE.
- 18. CONTRACTOR SHALL BE RESPONSIBLE FOR MAINTENANCE OF ALL PLANTING FOR A PERIOD OF ONE YEAR AFTER PLANTING. THIS PERIOD SHALL INCLUDE WATERING, FERTILIZING, AND WEED CONTROL AS NECESSARY TO MAINTAIN THE PLANTING IN A HEALTHY STATE.

2 LANDSCAPE NOTES

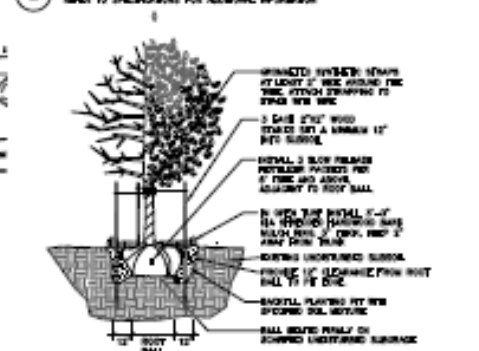

3 DECIDUOUS TREE PLANTING & STAKING

New landscape plan